

Company Introduction

Goldway Hardware Products Co., Ltd, as a member of **GOLDWAY GROUP LIMITED**,

is located in Yantai, China, established in 1999, is collection R&D, production and sales all kinds of Doors, such as Garage doors, Rolling doors, Industrial doors, Gates & Fence, Door motors and all kinds of hardware parts and tools.

In current, we are exporting our products to many countries. Our good service, best quality and reasonable price are getting more and more praise from our customers.

We manufacture and customise any style of the products with any quantity you need in a short time. In order to meet the different requests from different customers, we equipped the advanced machinery equipments, established the professional R&D team, got enough workers, when get your order request, we will design and make the products as per your requested style, and then put into rigorous manufacture. The whole process is rigorous and high-efficiency.

Simply, we deeply believe and practise the following three core elements in doing business with our business partners and customers:

Quality

Competitive Pricing

On-Time Delivery

We always put the high quality and good reputation at the first, highly appreciate to have happy cooperations with the friends from all over the world, and welcome to our factory for visiting !

Goldway

Contact: Judyliu Mobile/whatsapp/wechat: 86-15865968095 E-mail: gwgsales@yeah.net Add: Shandong, China

Overhead Sectional Garage door



Overhead Sectional Garage door

Design of door opening

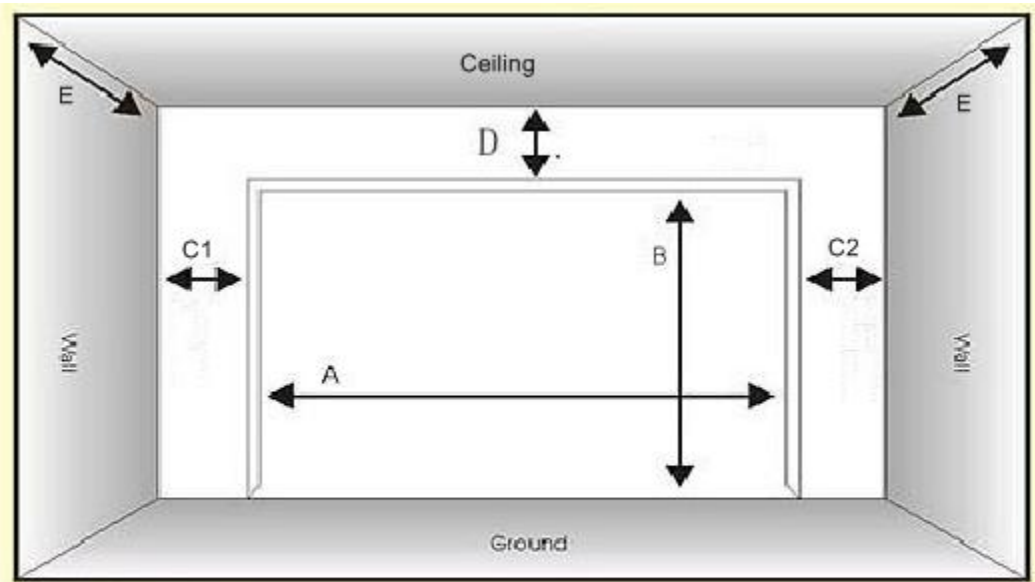

A: width B: height C1:leftroom C2:rightroom D:headroom E: depth of ceiling

- Need to know the size of door opening as A,B,C,D,E, to design the suitable garage door.

Door parts name

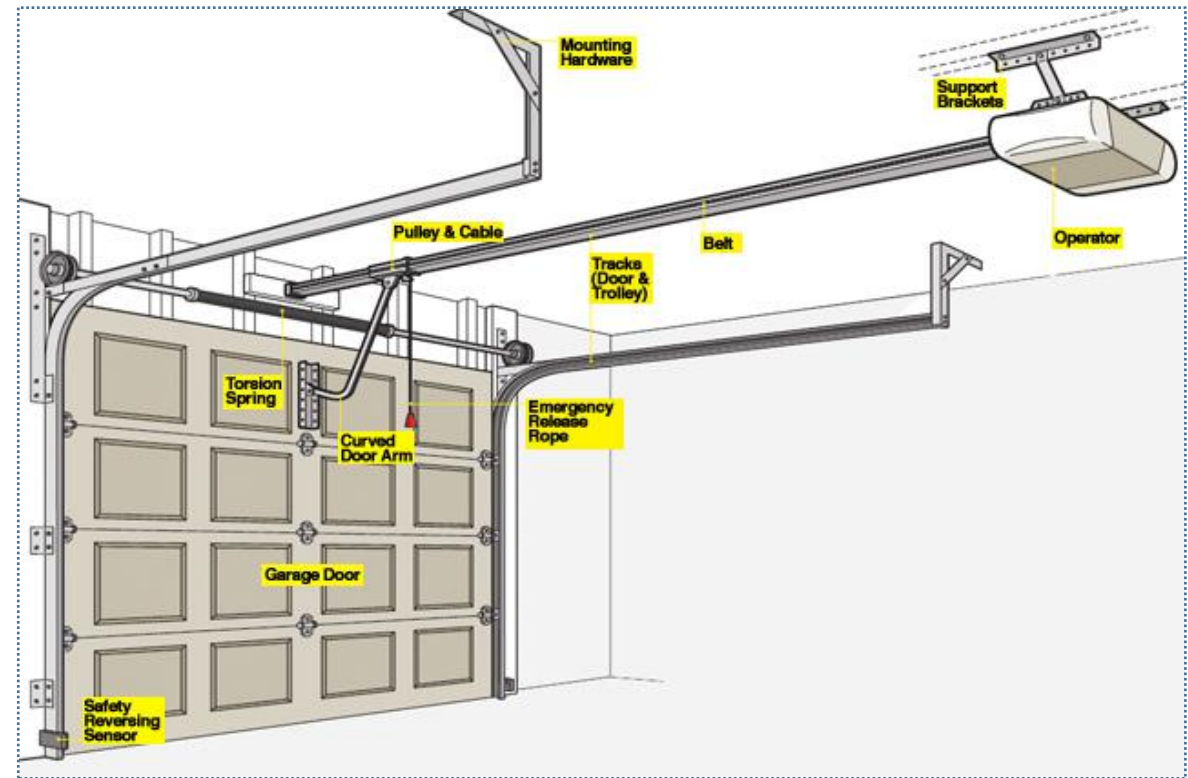

Overhead Sectional Garage door

◆ Door panel:

- 1. Panel Style:** Finger protection panels, using galvanized steel, standard 0.35mm thickness
- 2. Color:** The normal colour is white, and any other colour can also be customized as requested, such as silver grey, dark grey, blue, brown, black, golden oak, black walnut, etc..
- 3. Foam density:** 40--42kg/m³
- 4. Panel thickness:** 40mm
- 5. Panel surface:** Wood grain, Line wood grain, Square wood grain, Micro grain, Orange peel

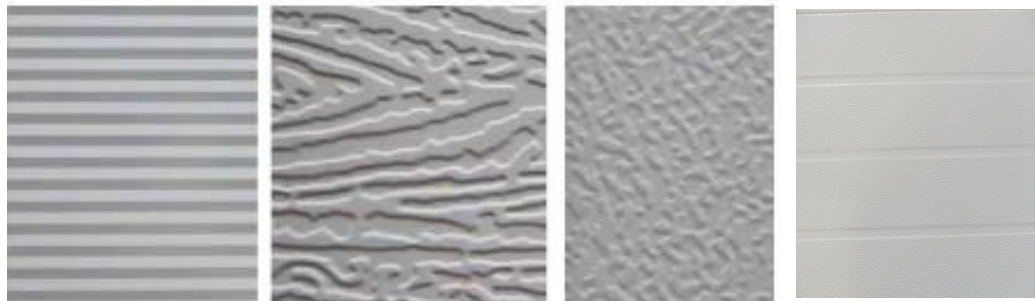

Micro grain Wood grain Orange peel Line wood grain

- Finger protection design



Square wood grain with colors:

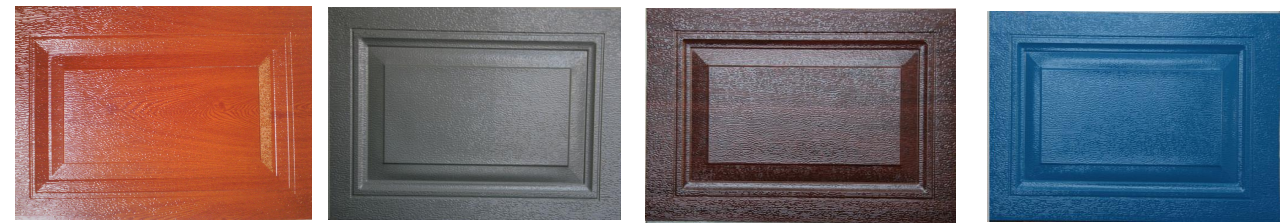

Golden oak Silver grey Black walnut Blue

Overhead Sectional Garage door

◆ Door hardware:

1. **Materials:** galvanized steel---- prevent rust.
2. **Track:** Single track--- suitable headroom $\geq 350\text{mm}$
Double track---suitable lower headroom distance $\geq 220\text{mm}$
3. **Emergency lock**---in case of power fault/off.
4. **Spring break safety brackets** is available.
5. **Good seals:** sealing strip around and built-in, can prevent wind, sand, and rainwater from erosion
6. **Perfect balance system** with strong torsion springs.



Overhead Sectional Garage door

◆ Windows

1. Provide multiple exquisite windows, with various specification, size and style

2. Fix with Plexiglass

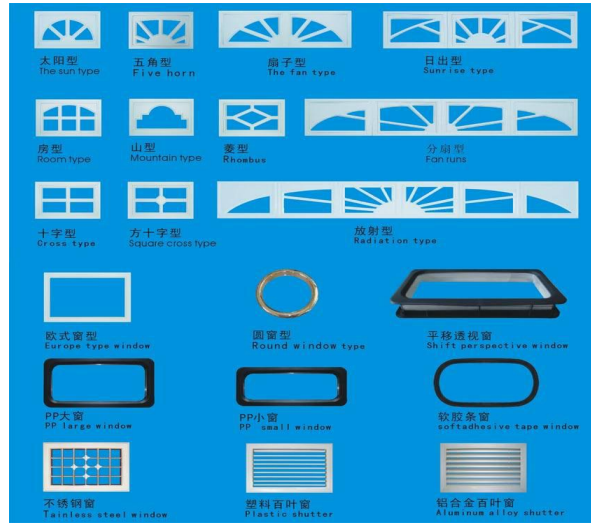

◆ Door opener

- 1.600N,800N,1000N,1200N
- 2.AC220V/50HZ,AC110V/50HZ
- 3.DC24V
- 4.with 2pcs remote controllers
- 5.motor shaft:3.3m,3.6m,3.9m etc.
- 6.Warranty: 2year

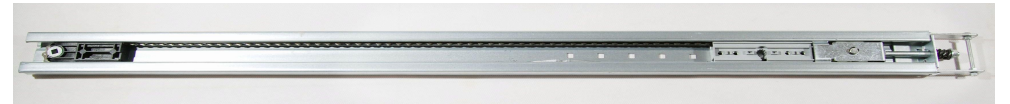

Overhead Sectional Garage door

◆ Package

Common package --- carton box and foam

1. If delivery only a few of doors by LCL, taking extra polywood case package for each door to protect them during transportation.

2. If delivery more quantity in FCL shipment, common package is enough.



polywood case package



container package

Sectional Industrial door (Vertical lift /Overhead lift)



- Galvanised steel and PU foam infilled , the door panel thinckness is 40mm and 50mm,used for big factory door

Top hanging sectional door

A new and special Lifting Method ,
is being a new type to instead of
Overhead Sectional Door,
Rolling Door,
Folding Door,
will famous in all over the world !

Lifting Method

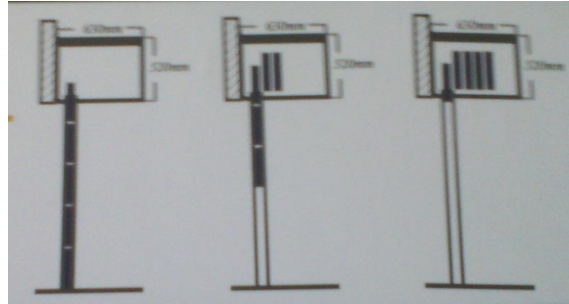

Available size

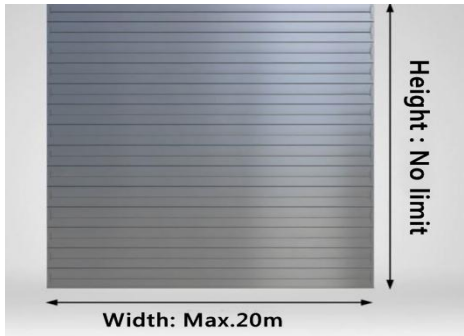

Good Ventilation

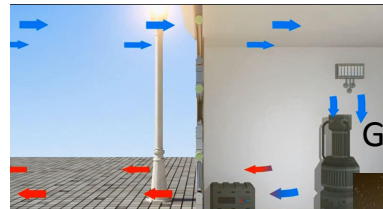

Good insulation

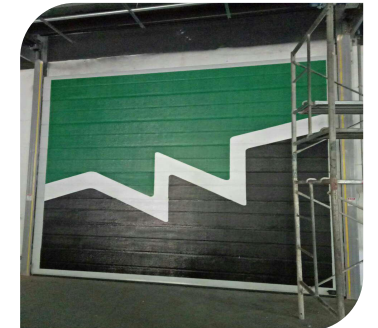

- Use the same door panel with Overhead sectional garage door or sectional Industrial door
- Suitable to use for many places, strong wind resistance, good insulation effect, good ventilation, very safe

Rolling door/Roll up door



Australian rolling door



- Single galvanised steel, 0.4mm thickness



European rolling door



- Double galvanised steel with 0.4mm thickness, PU foam infilled
- Slat width: 77mm



European rolling door



- Double aluminium alloy, with thickness 0.7mm
- Slat width: 77mm, 55mm, 50mm, 37mm



European rolling door



- Single aluminium alloy with holes, thickness 0.7mm
- Slat width: 77mm, 49mm

Rolling door/Roll up door



Industrial rolling door



- Double galvanised steel, 0.6mm or 0.8mm thickness, with PU foam infilled
- Single galvanised steel, 0.6mm or 0.8mm thickness
- Suitable for factory or other large door, and hurricane



PVC High speed rolling



- Door curtain: 0.8-1.2mm PVC high-density coated fabric imported from French
- Control mode: The radar sensor/ light sensor/ Magnetic sensor/ Wireless remote control/ Pull rope/ Button/ Access control card system



Aluminum High speed spiral rolling door



- Double Aluminum plate (0.7mm) with PU foam infilled
- Control mode: The radar sensor/ light sensor/ Magnetic sensor/ Wireless remote control/ Pull rope/ Button/ Access control card system



Transparent rolling door

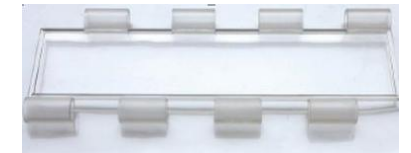

- PC materials
- Suitable for shop, bank, etc

European Rolling door/Roll up door

- 1.Materials:** Galvanised Steel or Aluminum alloy slats optional, with or without insulation.
- 2.Door parts:** All the door parts are ready .
- 3.Motor:** Use tubular motor or side motor.
- 4.Common color:** white , and any other colors can be customized.
- 5.Opening ways:** Manual, electric and remote-controlled operation.
- 6.Widely used for** roller shutter window and door , garage door, industrial door, commercial door, storage door, store door, Home security window and door, hurricane shutter, storm door.

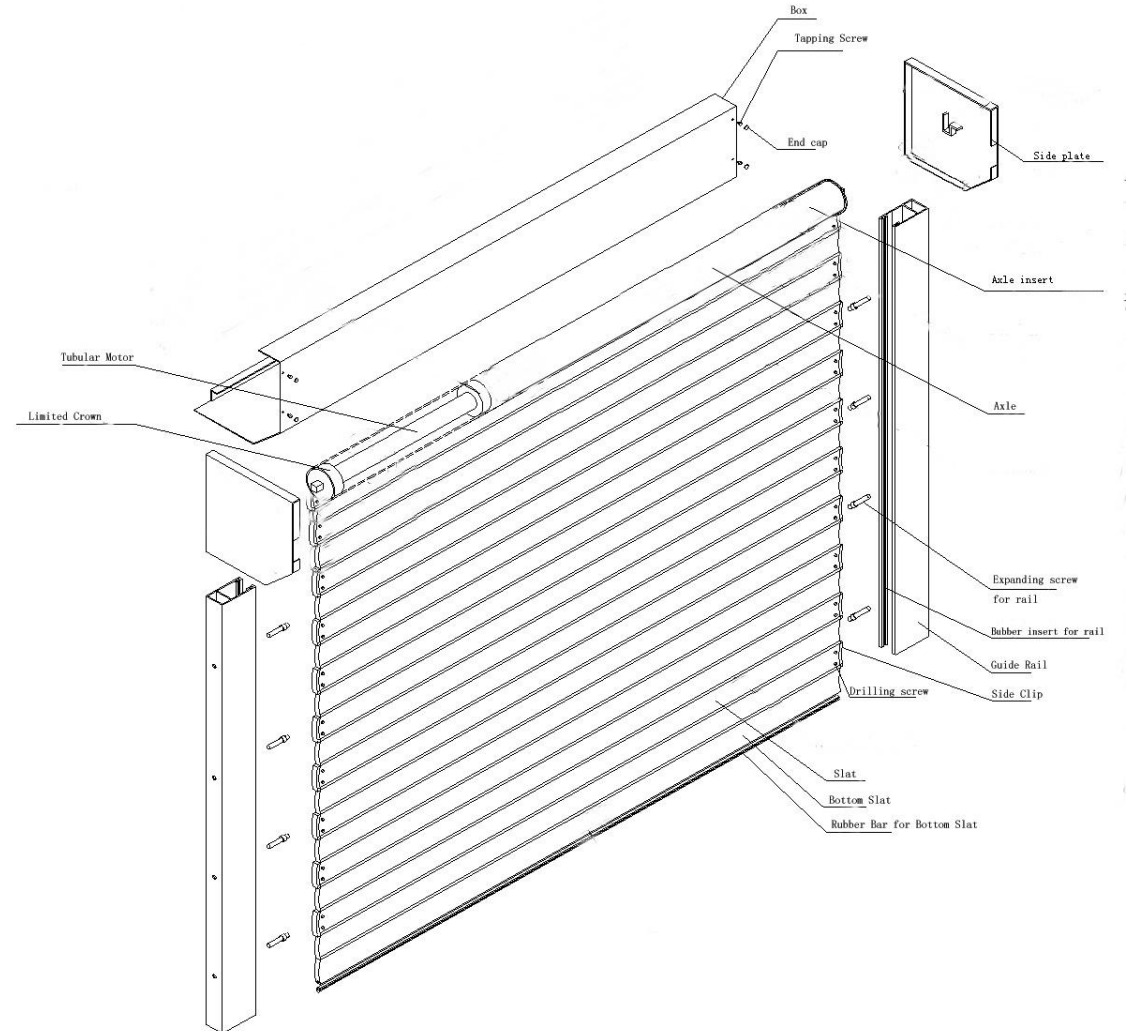

Australian Rolling door

- 1.Materials:** Single Galvanised Steel 0.3mm , 0.4mm
- 2.Door parts:** All the door parts are ready .
- 3.Motor:** Motor is optional , usually it is manual.
- 4.Common color:** white , and any other colors can be customized.
- 5.Opening ways:** Manual, electric and remote-controlled operation.
- 6.Widely used for** roller shutter window and door , garage door, commercial door, storage door, store door, Home security window and door.

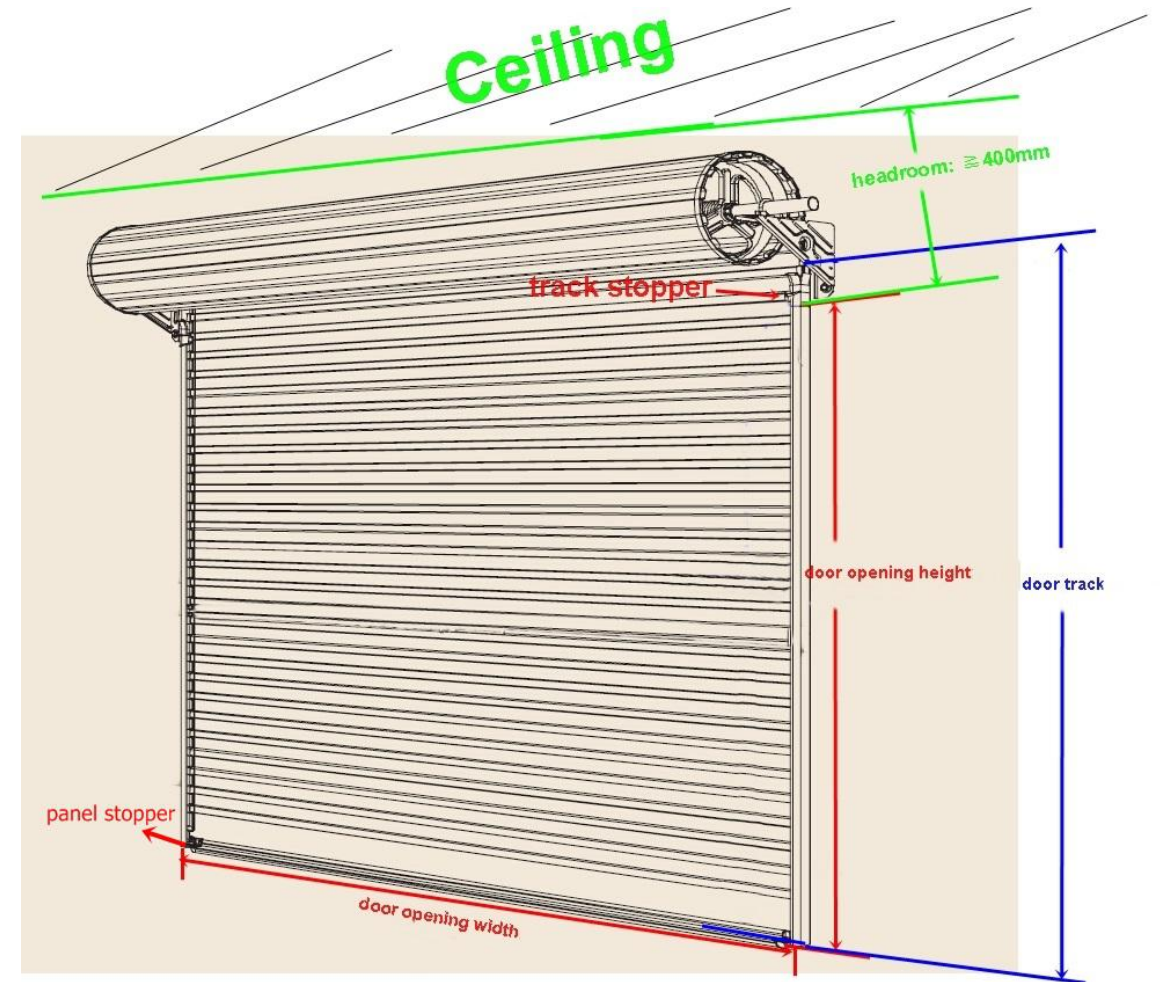

Door Opener/Motor

◆ Sectional Garage Door opener/motor

- 1.600N,800N,1000N,1200N, 1500N
- 2.110/220/240V+-10% 50/60Hz,DC24
- 3.with 2pcs remote controllers
- 4.motor shaft:3.3m,3.6m,3.9m etc.
- 5.Warranty: 2year



◆ Australian Roller door opener/motor

- 1.Voltage:110/220/240V+-10% 50/60Hz
- 2..Speed of up and down 0.13-0.18m/s
- 3.Elevating power(without spring)
≤26N 26kg
- 4.Maximum route:4M
- 5.Working temperature:-15-+40°C

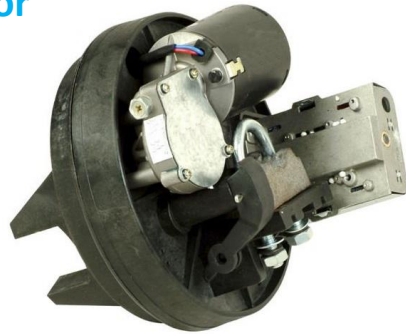

◆ Tubular door opener/motor



- 1.Voltage:110/220/240V+-10% 50/60Hz
- 2.Make a range of tubular motor from 3Nm--300Nm.
- 3.electronic type, manual type and clutch type.
4. many types of accessories can be choose.
- 5.35,45,59,92mm motor tube.

◆ Roller door opener/motor

- 1.Voltage:110/220/380V+-10%
50/60Hz
- 2.200KG/300kg/500kg/600kg/800kg/
1000kg/1300kg/1500kg/2000kg
Suitable For Different Weight Of
Doors.
- 3.Working temperature:-20-+50°C

