



Catalog

Company Profile **P04**

Sales Network **P06**

PRODUCTS SELL LIKE HOT CAKES

DM-581	Plasma Skin Care Device	P10
DM-516	Reskin II Needle Free Mesotherapy & Hydro Dermabrasion	P12
DM-718	Velashape Body Contour System	P14
DM-719	V8 EXtreme Shaping Machine	P16
DM-518	MSILKY Multifunctional Skin Care Management System	P18
DM-512	Reskin I Needle Free Mesotherapy	P20
DM-510	HIFU Face and Body Lifting & Tightening	P22
DM-809	Picosure Laser	P24
DM-817	Advanced 808nm Diode Laser & 755nm Alexandrite Laser Hair Removal	P26
DM-818	Vacuum-assisted 808nm Diode Laser Hair Removal	P28
DM-808B/DM-808T	808nm Diode Laser Hair Removal	P30
DM-808C	Diode Laser Hair Removal Machine	P32
DM-808E	Diode Laser Hair Removal Machine	P34
DM-V12	4 in 1 Cryolipolysis Cavitation RF Slimming	P36
DM-V125	Cryolipolysis Fat Freezing Slimming	P37
DM-511	High Frequency Antiaging Machine	P38
DM-9006	Nd Yag Laser Tattoo Removal	P39
DM-9011	OPT SHR Machine	P40
DM-9011T	Portable SHR Machine	P41
DM-9002C	SHR Laser RF Beauty Machine	P42
DM-9011D	One Handle SHR Machine	P43
DM-802	Fractional Co2 Laser Machine	P44
DM-522	HIFU Face Lifting And Vagina Tightening Beauty Machine	P45

Certification & Training **P47**

Our Service **P48**

OEM / ODM

Professional OEM & ODM Supplier

11 Years Production & 9 Years Export



COMPANY PROFILE

Guangzhou Dimei Beauty Technology Co., Ltd is specialized in Beauty and Medical Equipment with our own R&D department, Design & Production and Sales &Service team, and we sell our machines to all over the world, and winning best comments for product quality and after service.



Wide Product Range

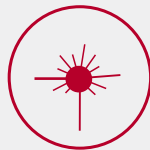

Laser & SHR OPT

Picosecond & Picosure 755nm Laser
808nm Diode Laser Hair Removal
Vacuum-Assisted 808nm Diode Laser
755nm Alexandrite Laser Hair Removal
CO2 Fractional Laser
Q-Switch Yag Laser Tattoo Removal



Facial Skin Care

Ultrasound HIFU Facelift and
Body Slimming
Reskin Needle Free Mesotherapy
Injection
Hydra Facial Peeling Cleansing
Reskin Needle Free Mesotherapy
Injection



Body Slimming Shaping

Picosecond & Picosure 755nm Laser
808nm Diode Laser Hair Removal
Vacuum-Assisted 808nm Diode Laser
755nm Alexandrite Laser Hair Removal
CO2 Fractional Laser
Q-Switch Yag Laser Tattoo Removal

Brand



Plasmjet™ Plasma Skin Care Device

DM-581

High Purity Helium Plasma, New Non-ablative
Non-invasive Skin Regeneration Technology.



Anti-septic



Tissue
regeneration

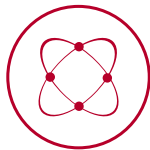

Skin
Resurfacing



Destruction of
skin defects



THE HANDLE



Ultrapulse Plasma



Non-hot Pressed Plasma

SPECIFICATION

Power: 250W

Voltage: 220-240V, 50-60HZ

Using Program: Unipolar Dual Terminal

Issuance Program: Super Strong Pulse With High Peak

Output Power: Skin Tighten Max 200W Skin Rejuvenation Max 131W

Operation & Control: Micro Control System Touch Keyboard

High Frequency Leakage Current: <150mA

Frequency: 1.75MHZ

Temperature: 10°C-40°C (20°C-25°C Preferred)

Humidity: 30%-75%,Non-condensing

G.W.: 11KG

Packing Size: 38×51×121cm

ADVANTAGES

- 1.** Energy Accurate, Efficient Transfer
- 2.** Uniform Heat Transfer Efficiency
- 3.** Thoroughly Remove Other Gases
- 4.** Suit for All Skin Type
- 5.** Unique Design
- 6.** Non-Ablative, Non-Invasive

APPLICATION

Anti-septic

Brighten Skin Tone

Tissue regeneration

Skin Resurfacing

Destruction of skin defects

HOW IT WORKS?

The helium gas separates under the action of energy to form a plasma, and the instantaneous release of energy is transmitted to the tissue through the moisture in the skin, and the energy is converted into heat energy, which stimulates a large amount of collagen regeneration, thereby tightening the skin and removing wrinkles. Immediately after the sputum ion reaches the skin, the stored energy is released to the surface of the skin, thereby producing a uniform tissue heat effect on the skin.

BEFORE & AFTER



Reskin[®]
Device II

**Reskin II Needle Free
Mesotherapy & Hydro Dermabrasion**

DM-516

Beautiful Skin Instills a Deep Confidence That Amplifies Inner Beauty



Deep
Cleanse Skin



Skin
rejuvenation



Improve
Complexion



Reduce
Fine Lines



Moisturize
Skin



Skin Lifting



THE HANDLE



Reskin Handpieces



Hydro Dermabrasion



Skin Scrubber



RF lifting



Ultrasonic



Cold Hammer

SPECIFICATION

Power:500W

Adjustable Mode: CON&INT

High Pressure: 5KG/CM2-10KG/CM2; 850Kpa

Penetrate Depth: 0.2MM-0.3MM

Dose capacity: 1UL-24UL

Cold Hammer Temp: 0-5°C

Wet Standing Vacuum Flow: 30L

RF Output : 5MHZ

Ultrasonic: 1M

ADVANTAGES

- 1.** Multifunctional Solve All Skin Problem
- 2.** High Pressure Injection
- 3.** High Vacuum Pressure Cleanse Skin Deeply
- 4.** Non-Invasive ,Painless And Bloodless Therapy
- 5.** Obvious Different Result After First Treatment
- 6.** Hydrating Facial Without Needles
- 7.** Optimistic Market Expectation

APPLICATION

Lift&Tightening Skin

Moisturize skin

Improve Complexion

Reduce Fine Lines

Deep Cleanse Skin

Skin Rejuvenation

Whiten Skin

HOW IT WORKS?

Reskin II is a safe and reliable Multifunctional skin care device .Hydro Dermabrasion Combine with Needle free mesotherapy . It utilizes the natural healing powers of water and oxygen to effortlessly exfoliate the skin without the use of hard crystals or abrasive textured wands, generating deeply hydrated and healthier looking skin.

Free Needle Mesotherapy Non-invasive solution for whitening and anti-aging,is to use high pressure ejector combined with high frequency ultrasonic technology to penetrate into skin and allows cells to absorb the active ingredients contained within these vital nutrients to supplement moisture and nutrients for the skin, which makes skin smooth moist and energetic.

BEFORE & AFTER





Velashape Body Contour System

DM-718

Slender Waist Perfect Body Skin Tighten

THE HANDLE



Big rotate cavitation



Moderate rotate cavitation



Small rotate cavitation



180°Rotation
Vacuum Cavitation



RF with 40K



Vacuum RF



Multipole RF



Facial Vacuum RF



Facial RF



SPECIFICATION

Machine name: slimor

Power: 800W

Depth: 0.3MM-3MM

Voltage: 110V/220V 50HZ/60HZ

Rotation Angle: 180°

Vacuum: 0-90Kpa

Cavitation: 40Khz

RF: 5Mhz

Screen: 10.4 inch color touch screen

G.W.: 60KGs

Meas.: 50.5x52x113cm

ADVANTAGES

- 1.** Suit all people, all fat types
- 2.** Unique Combined technology RF with 40K
- 3.** Comfortable Vacuum RF with rotation massage treatment
- 4.** Short treatment sessions and outstanding results, from as little as a single session
- 5.** Zero downtime and little or no discomfort
- 6.** High patient satisfaction

APPLICATION

Cellulite Reduction

Lift & Tighten Skin

Body Contouring & Shaping

Promote Blood and Lymphatic Circulation

HOW IT WORKS?

Slimor is a vacuum Rotation massage treatment, combined with 40K cavitation, Vacuum, RF for body contouring & cellulite reduction, with zero downtime and amazing results. These four technologies allow you to provide highly effective and tailored treatments for a variety of challenging obesity concerns. With these four treatments, you can easily handle. You can treat all areas of the body, treat all skin types, and meet the needs of all populations.

BEFORE & AFTER



V8 EXtreme Shaping Machine

DM-719

An Affordable Solution to Treat Cellulite and Reshape the Body



Face Lift



Skint Tighten



Body Shaping



THE HANDLE



RF with 40K



Vacuum RF



Multipole RF



Facial Vacuum RF



Facial RF

SPECIFICATION

Machine name: V8 EXtreme Shaping Machine

Power: 500W

Voltage: 110V/220V 50HZ/60HZ

Vacuum: 0-90Kpa

Cavitation: 40Khz

RF: 5Mhz

Screen: 8.4 inch color touch screen

G.W.: 60KGs

Meas.: 50.5x52x113cm

ADVANTAGES

- 1.** Safe and Effective for All Fat Types
- 2.** Unique Combined technology RF with 40K
- 3.** No Patient Downtime
- 4.** Portable Design
- 5.** High patient satisfaction

APPLICATION

Cellulite Reduction

Lift & Tighten Skin

Body Contouring & Shaping

Promote Blood and Lymphatic Circulation

HOW IT WORKS?

V8 is a treatment combined with 40K cavitation ,Vacuum, RF for body contouring & cellulite reduction,with zero downtime and amazing results.These four technologies allow you to provide highly effective and tailored treatments for a variety of challenging obesity concerns. With these four treatments, you can easily handle. You can treat all areas of the body, treat all skin types, and meet the needs of all populations.

BEFORE & AFTER





MSILKY Multifunctional Skin Care Management System

DM-518

One Skin Management Machine, 9 Different Therapies
Address All Skin Care Needs



Deep cleanse



Skin lifting



Improve complexion



Moisturize skin



THE HANDLE



LED Photontherapy & Pure Oxygen Injection Mask

Cold Hammer



Hydra Dermabrasion



RF with 1470nm Laser



Spray Water Oxygen Jet



SPECIFICATION

Power: 400W

Cold Hammer Temp: 0-5°C

Oxygen Mask with Bluetooth Music: Pure 90% Level, 5L Capacity

Led Mask: Single Red, Green, Blue, Yellow light or Dual Combination Optional

RF Frequency: 10MHZ Multipolar RF

Laser Wavelength: 1470nm Far Infrared

Wet Standing Vacuum Flow: 30L

Water-Oxygen Atomization Pressure: 6kg

Package Size: 48x75x118cm

Gross Weight: 60KG

ADVANTAGES

- 1.** Multifunctional 9 in 1 Skin Care Management
- 2.** Various Eddy Current Probes Available
- 3.** Special Comfortable Oxygen Photontherapy with Pleasant Music
- 4.** High Vacuum Pressure Cleanse Skin Deeply
- 5.** Fashionable and Environmentally Friendly Design
- 6.** Optimize Your Return on Investment
- 7.** Low Cost Per Treatment, Finally More Profit

APPLICATION

Deep Cleanse Skin

Lift & Tighten Skin

Moisturize Skin

Improve Complexion

Rejuvenate Skin

HOW IT WORKS?

Msilky™ is a safe and reliable multifunctional skin care device, not only improve the looks of your skin, but with frequent treatment, will restore skin health. It is a highly efficient, wide-ranged treatments, full-featured integrated beauty instrument. It has five function handpieces which can tighten skin, remove acne, blackhead, and speckle, tender skin, whiten, moisturize and cleanse skin.

BEFORE & AFTER



Reskin[®]
• Device

Reskin | Needle Free Mesotherapy

DM-512

3 Steps, 30 Minutes, The Best Skin of Your Life



Skin rejuvenate



Skin moisturize



Wrinkle removal



THE HANDLE



Address All Skin Care Needs Combined with Various
Cosmetic Products
Such as Hyaluronic Acid Product

Moisturizing
Hydrating
Whitening
Anti-aging
Skin Tighten



ADVANTAGES

1. Effective for All Skin Types
2. Address All Skin Care Needs
3. Without Needles, No Consumable
4. Obvious Quick Instant Treatment Result
5. High Pressure 850KPa
6. Deeply Penetrate Depth 2MM-3MM

HOW IT WORKS?

With 450m/s high speed and 850KPa high pressure, the nutrients product are injected into the skin deeply, 2MM-3MM dermal layer, without any needle, any pain and redness, to moisturize skin and improve complexion.

APPLICATION

Lift & Tighten Skin

Moisturize Skin

Improve Complexion

Rejuvenate Skin

Whiten Skin

Reduce Fine Lines

Minimize Dark Spot

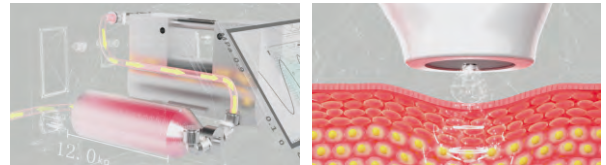

BEFORE & AFTER



ACEHIFU™

HIFU Face and Body Lifting & Tightening

DM-510

HIFU – A Nonsurgical Way To Lift, Tighten, And Tone Skin



Face lift



Antiaging



Wrinkle Removal



THE HANDLE



THE CARTRIDGES



10-1.5

7-3.0

4-4.5

4-8.0

4-13.0

Standard

Optional

FIVE DIFFERENT CARTRIDGES

Projects	Facial			Body	
The probe	DS10-1.5	DS7-3.0	DS4-4.5	DS4-8.0	DS4-13.0
Frequency	10MHz	7MHz	4MHz	4MHz	4MHz
The depth	1.5mm	3.0mm	4.5mm	8.0mm	13mm
Skin layers	Superficial Dermis	Deep Dermis	SMAS	Subcutaneous Dermis	Subcutaneous Dermis

SPECIFICATION

Power: 150W

Tech: High Intensity Focused Ultrasound

Transducers of Face: DS 10-1.5 DS 7-3.0 DS 4-4.5

Extra Transducers of Body Optional: DS 4-8.0 DS 4-13.0

Energy Range: 0.1-0.4J 0.2-0.75J 0.3-1.2J

Max Length: 25mm

Heating Temperature: 60-70 °C

Lifespan of Probe: 5000 Shots/Transducer

Package Size: 48x59x59cm (Machine)

56x62x134cm (Stand trolley)

Weight: 22KG (Machine)

14KG (Stand trolley)

ADVANTAGES

1. Deliver Truly Unique Results
2. Align with Patient Demand
3. Generate Industry Leading ROI
4. No Patient Downtime
5. Safe & Proven Ultrasound
6. 8.0mm & 13.0mm Body Transducers Optional

APPLICATION

Face Lift

Skin Tightening

Wrinkles Removal

Body Contouring

HOW IT WORKS?

HIFU is High Intensity Focused Ultrasound, HIFU treatment is a new form of treatment for skin tightening and face lifting. It bypasses the surface of the skin and delivers high intensity focused ultrasound energy to the SMAS layer which typically addressed in cosmetic surgery. This energy triggers a natural response under the skin, jumpstarting the regeneration of fresh new collagen, which gives your a glimmer and tighter look.

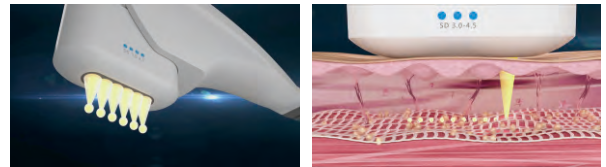

HIFU Ultrasonic energy is direct to fascial layer

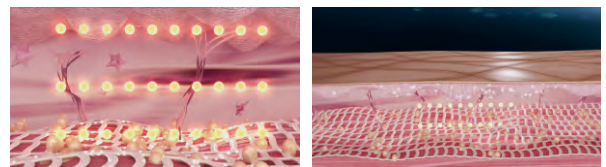

Promote the regeneration of collagen recombinant and the facial tightening to improve the shaping

BEFORE & AFTER



Picosure Laser

DM-809

The Perfect Treatment For Pigment When You Have Not Time For Downtime



500ps
Ultra-short
Pulse



532nm 755nm
1064nm Three
Wavelength



New Picosecond
Laser Technology



THE HANDLE

South Korea Original Guide Arm
(Spot size:2-10mm)



Top BEAMTECH Laser Source

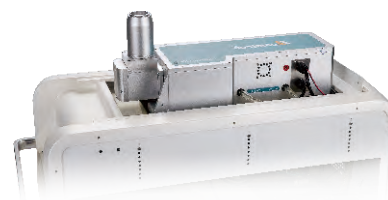

SPECIFICATION

Laser Type: Pico laser
Laser Source: Top BEAMTECH Brand Laser Generator
Working Mode: Pulse Output
Leading Light: Infrared Light Guidelines
Guide Arm: South Korea Original Imported
Wavelength: 755nm \ 1064nm \ 532nm
Pulse: 500ps
Laser Energy Power: 500MJ 1200MJ
Spot Size: 2-10mm Diameter (Adjustable)
Warranty Shot: 5 Million Laser Shots
Screen: 10.2 inch color touch
Power: 2000W
Frequency: 1-10HZ
Cooling: Water +Air+ Semiconductor cooling
Meas: 62x138x148CM
G.W: 130KG

ADVANTAGES

1. Top BEAMTECH Brand Laser Source
2. 500ps Ultra-short Pulse Width
3. 532nm 755nm 1064nm Combined Wavelength
4. Korean Imported Original Laser Guide Arm
5. 500MJ-1200MJ High Power Energy
6. Max 1.4J, Pigment Instantly Crushed
7. Professional & Effective Freckle Tattoo Removal
8. Adjustable Energy & Spotsize
9. Full Solution For Variety Skin Problems

APPLICATION

Chloasma removal

Age spot removal

All kinds of tattoo removal

Skin rejuvenation and pore contraction

Nevus of Ota, freckle, dermis spot, birthmark removal

Embroider eyebrow, embroider eye line, lip line removal

HOW IT WORKS?

The Picosecond Laser uses ultra-short pulses (one trillionth of a second in length) to hit the melanin with a great pressure, the melanin shatters into tiny dust-like particles, which will be more readily absorbed and eliminated by the body.

Picosecond Laser is a quick and easy non-surgical, non-invasive laser skin treatment for whole body. Combined with 532nm and 1064nm, more therapies and more effective.

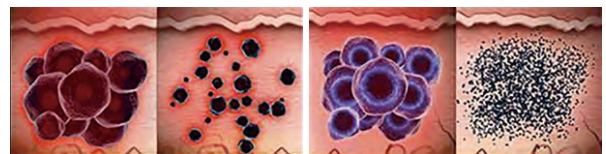

Schematic diagram of pipe-second freckle

BEFORE & AFTER



LASERHR

Advanced 808nm Diode Laser & 755nm Alexandrite Laser Hair Removal

DM-817

High Efficient for Removing All Colors' Hair, Permanent, Pain-free.



808nm&755nm
Dual Wavelengths

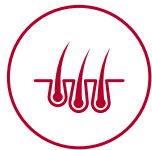

Suit for All
Color's Hair



Microchannel
Cooling System



THE HANDLE

808nm Diode Laser Handpiece
400W or 600W Optional)

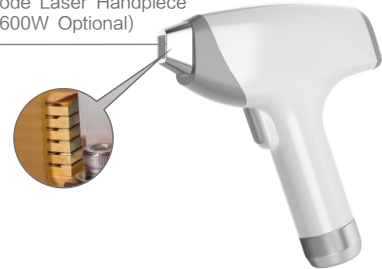

755nm Alexandrite Laser Handpiece
Laser Bar Power: 1200W

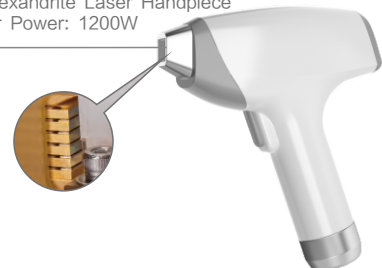

SPECIFICATION

Machine name: Diode Laser Hair Removal Machine

Technology: Diode Laser & Alexandrite Laser

Pulse Energy: 1-88J/CM²

Spot Size: 14×14mm or 16×16mm

Laser Bars Power: 400W or 600W (808nm);1200W (755nm)

Head Lifetime: 10 million Shots

Bars Number: 12 bars (755nm); 4 bars or 6 bars optional (808nm)

Frequency: 1-10MHZ

Refrigerating System:TEC Cooling+air+water+semi-conductor cooling

Packing size: 72×82×124cm

Weight: 87KG

ADVANTAGES

1. 755nm & 808nm Double Wavelengths
2. Germany Laser Bars
3. Advanced Microchannel Cooling system
4. High Max energy 88J/cm²
5. 15 hours continuous working time
6. All types of skin, all hairs
7. In motion fast hair removal technology
8. Automatic checking alarming system

HOW IT WORKS?

755nm, 808nm wavelengths diode laser can effectively penetrate deep into the hair follicle tissue, the laser energy is transformed into heat, which damages the hair papilla without damaging the surrounding tissue. The hair follicle tissue after absorbing the energy and heat of the laser can be heated around 50°C, this can cause hair follicles and growth stem cells lose growth activity then leads to permanent hair removal.

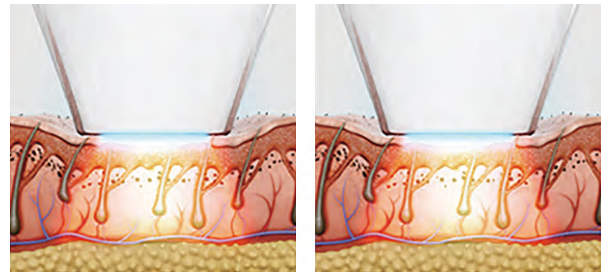

808nm Diode Laser

755nm Alexandrite Laser

APPLICATION

Permanent face hair removal

Full body hair removal

Chest and back hair removal

Arm, leg, bikini hair removal

BEFORE & AFTER

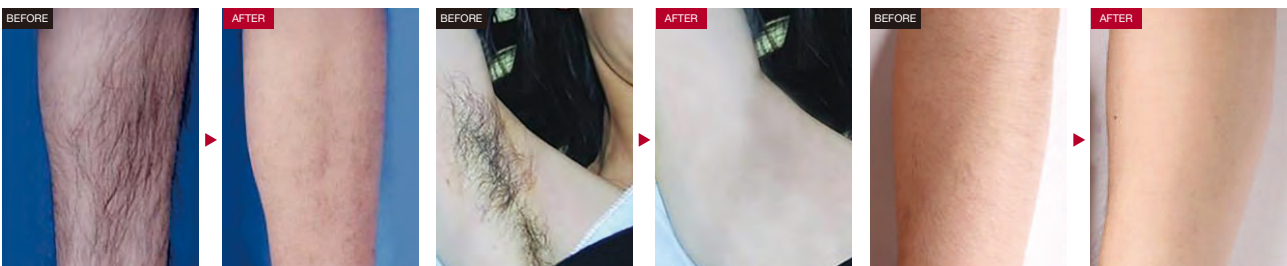

LASERHR^{TN}

Vacuum-assisted 808nm
Diode Laser Hair Removal

DM-818

High-Speed Vacuum Assisted Technology for large full body Treatment

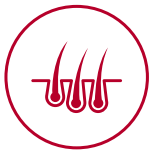

Fastest Effective
Hair Removal



Maximum
Comfortable
Treatment

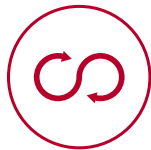

Microchannel
Cooling System



THE HANDLE

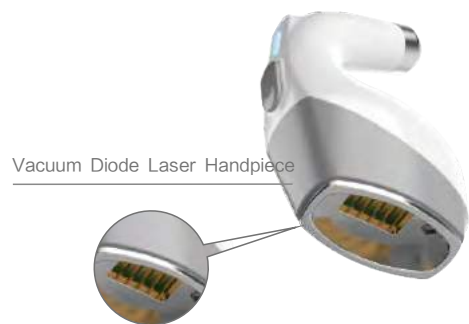

Vacuum Diode Laser Handpiece

808nm Diode Laser Handpiece
400W or 600W Optional)



SPECIFICATION

Machine name: Diode Laser Hair Removal Machine

Technology: High-Speed Vacuum Assisted Technology

Power: 2000W

Pulse Energy: 1-88J/CM²

Spot Size: 14x14mm or 16x16mm

Bars number: 4 bars or 6 bars optional

Laser Bars Power: 400W or 600W (808nm)

Head Lifetime: 10 million Shots

Frequency: 1-10MHZ

Refrigerating System: TEC Cooling+air+water+semi-conductor cooling

Packing size: 72x82x124cm

Weight: 87KG

ADVANTAGES

1. Shortest treatment time
2. Maximum comfortable
3. Germany Laser Bars
4. Advanced microchannel cooling system
5. High Max energy 88J/cm²
6. 15 hours continuous working time
7. Perfect for full body large treatment area
8. Automatic checking alarming system

APPLICATION

Permanent face hair removal

Full body hair removal

Check and back hair removal

Arm,leg,bikini hair removal

HOW IT WORKS?

High-Speed technology incorporates suction to elevate and stretch the skin. In doing so, the laser achieves maximum absorption into hair follicles while covering a large area, shortening treatment time and reducing the sensation of heat.

With High-Speed technology vacuum gently draws skin into the handpiece, stretching it thin and pulling the target closer to the energy source.

It uses a state-of-the-art diode laser handpiece with 808nm wavelength which allows a tailored treatment for wide skin types. A laser pulse targets and damages the hair follicle while the surrounding tissue remains unharmed.

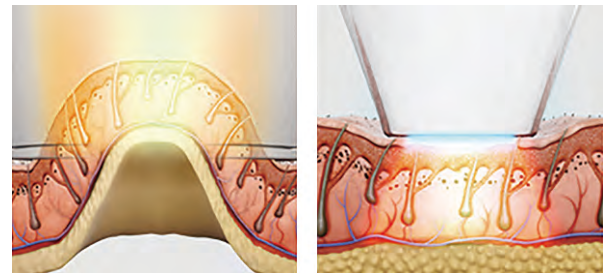

The 808nm depilation schematic

BEFORE & AFTER



LASERHR S

808nm Diode Laser Hair Removal

DM-808B/DM-808T

NO Hair, No Pain, No Side Effects



Freezing point

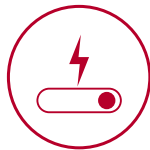

Swift



Safety



THE HANDLE

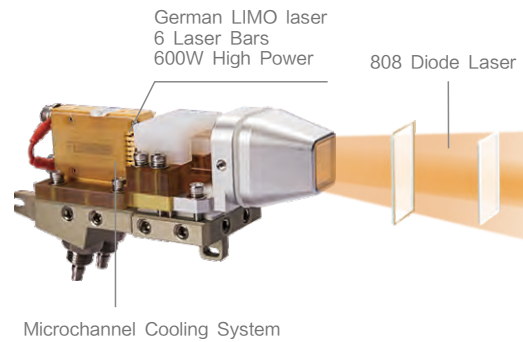

SPECIFICATION

Machine name: Diode Laser Hair Removal Machine

Technology: 808nm Diode Laser+Sapphire integrated cooling

Power: 2000W

Pulse Energy: 1-88J/CM²

Spot Size: 16×16mm

Bars number: 6 bars

Laser Bars Power: 600W

Head Lifetime: 10 million Shots

Frequency: 1-10MHZ

Refrigerating System: TEC Cooling+air+water+semi-conductor cooling

Package Size: 56×78×135cm (Aluminum Box)

Gross Weight: 87KG

ADVANTAGES

1. Germany Laser Bars
2. Advanced Microchannel Cooling system
3. High Max Energy 88J/cm²
4. Big Spot Size 16×16mm
5. 15 hours continuous working time
6. 10.4 Inch Big Touch Screen
7. In motion fast hair removal technology
8. Automatic checking alarming system
9. Permanent and Painless Hair Removal

APPLICATION

Permanent face hair removal

Full body hair removal

Check and back hair removal

Arm,leg,bikini hair removal

HOW IT WORKS?

808nm wavelength diode laser can effectively penetrate deep into the hair follicle tissue, the laser energy is transformed into heat, which damages the hair papilla without damaging the surrounding tissue. The hair follicle tissue after absorbing the energy and heat of the laser can be heated around 50°C, this can cause hair follicles and growth stem cells lose growth activity then leads to permanent hair removal.

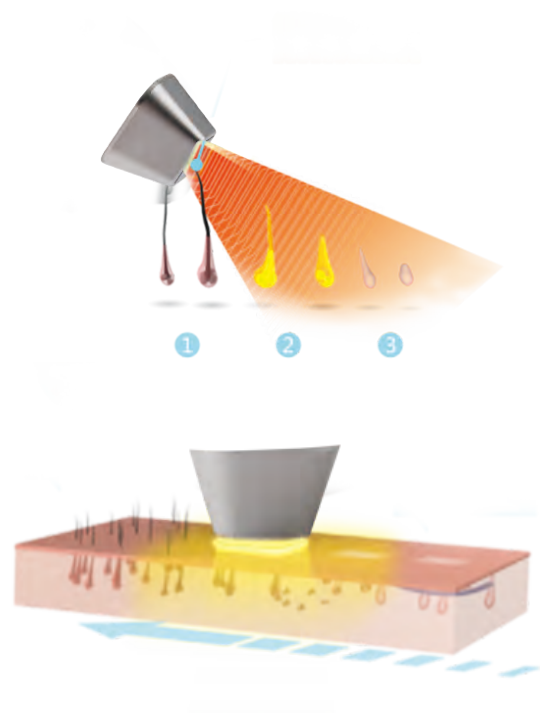

The 808nm depilation schematic

BEFORE & AFTER

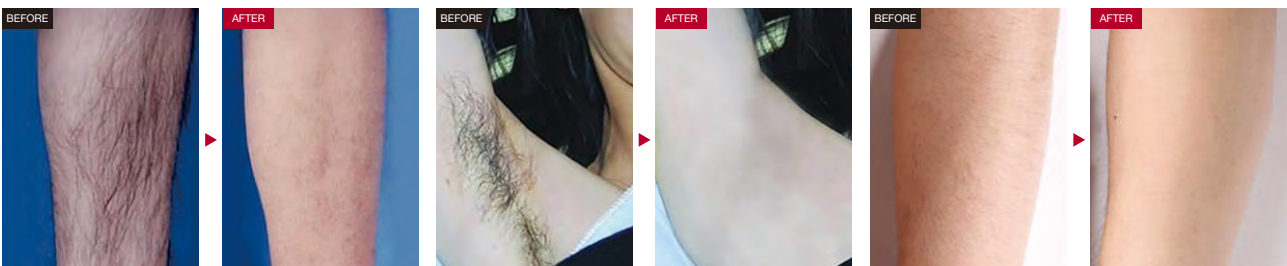

LASERHR

Diode Laser Hair Removal Machine

DM-808C

Permanent Hair Removal, So Easy



Freezing point

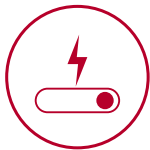

Swift



Safety



THE HANDLE

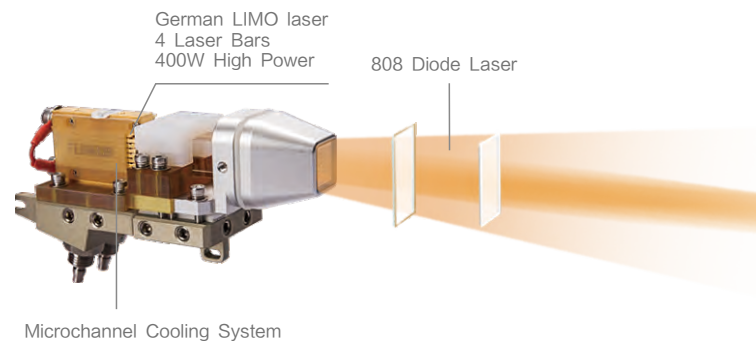

SPECIFICATION

Machine name: Diode Laser Hair Removal Machine

Technology: 808nm Diode Laser+Sapphire integrated cooling

Power: 1200W

Pulse Energy: 1-88J/CM²

Spot Size: 14x14mm

Bars number: 4 bars

Laser Bars Power: 400W

Head Lifetime: 10 million Shots

Frequency: 1-10MHZ

Refrigerating System: TEC Cooling+air+water+semi-conductor cooling

Package Size: 77x59x136cm (Aluminum Box)

Gross Weight: 78KG

ADVANTAGES

1. Germany Laser Bars
2. Advanced Microchannel Cooling system
3. High Max Energy 88J/cm²
4. Big Spot Size 14×14mm
5. 10 hours continuous working time
6. 10.4 Inch Big Touch Screen
7. In motion fast hair removal technology
8. Automatic checking alarming system
9. Permanent and Painless Hair Removal

APPLICATION

Permanent face hair removal

Full body hair removal

Check and back hair removal

Arm,leg,bikini hair removal

HOW IT WORKS?

808nm wavelength diode laser can effectively penetrate deep into the hair follicle tissue, the laser energy is transformed into heat, which damages the hair papilla without damaging the surrounding tissue. The hair follicle tissue after absorbing the energy and heat of the laser can be heated around 50°C, this can cause hair follicles and growth stem cells lose growth activity then leads to permanent hair removal.



The 808nm depilation schematic

BEFORE & AFTER



LASERHR

Diode Laser Hair Removal Machine

DM-808E

Permanent Hair Removal, So Easy



Freezing point

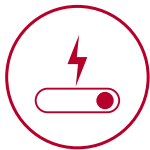

Swift



Safety



THE HANDLE

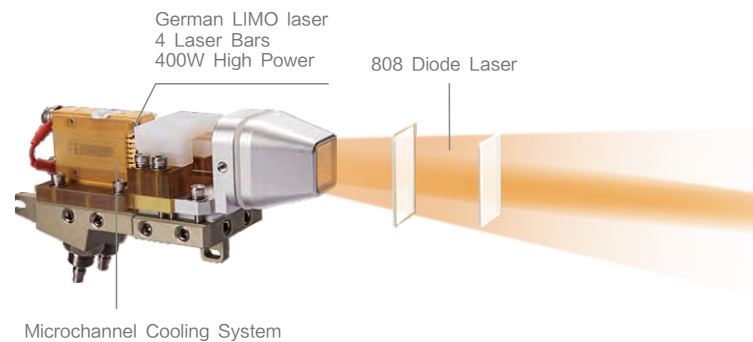

SPECIFICATION

Machine name: Diode Laser Hair Removal Machine
Technology: 808nm Diode Laser+Sapphire integrated cooling
Power: 1200W
Pulse Energy: 1-88J/CM ²
Spot Size: 14x14mm
Bars number: 4 bars
Laser Bars Power: 400W
Head Lifetime: 10 million Shots
Frequency: 1-10MHZ
Refrigerating System: TEC Cooling+air+water+semi-conductor cooling
Package Size: 77x59x136cm (Aluminum Box)
Gross Weight: 78KG

ADVANTAGES

1. Germany Laser Bars
2. Advanced Microchannel Cooling system
3. High Max Energy 88J/cm²
4. Big Spot Size 14×14mm
5. 10 hours continuous working time
6. 10.4 Inch Big Touch Screen
7. In motion fast hair removal technology
8. Automatic checking alarming system
9. Permanent and Painless Hair Removal

APPLICATION

Permanent face hair removal

Full body hair removal

Check and back hair removal

Arm,leg,bikini hair removal

HOW IT WORKS?

808nm wavelength diode laser can effectively penetrate deep into the hair follicle tissue, the laser energy is transformed into heat, which damages the hair papilla without damaging the surrounding tissue. The hair follicle tissue after absorbing the energy and heat of the laser can be heated around 50°C, this can cause hair follicles and growth stem cells lose growth activity then leads to permanent hair removal.



The 808nm depilation schematic

BEFORE & AFTER



4 in 1 Cryolipolysis Cavitation RF Slimming

DM-V12

To The Hell With Fat Deposit, Bring You Perfect Body

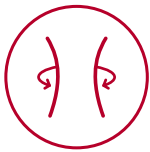

Slender waist



Perfect body



Skin tighten

ADVANTAGES

1. German Soft Tubes
2. Non-invasive Fat Freezing Reduction
3. Profitable Combined Application
4. Unique Design Suitable for Solving Various Obesity

THE HANDLE

40K Cavitation



Fat Freeze Cryo



6-Polar RF

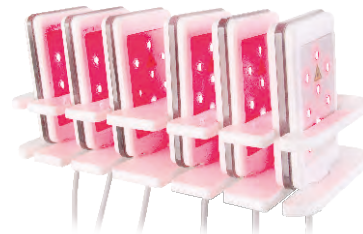

Lipo Laser



SPECIFICATION

Item:	DM-V12
Voltage:	110-240V,50/60HZ
Power:	800W
Number of Applicators:	4 kinds
Cavitation Frequency:	40KHZ
Temperature:	-14℃-15℃
Touch screen:	10.4inch color
RF:	5MHZ
Gross weight:	48KG
Pressure output:	0-900Kpa
Packing size:	55×62×123cm

DM-V125

Cryolipolysis Fat Freezing Slimming

Freeze Stubborn Fat Away, Say No to Surgery

ADVANTAGES

1. 4 Handpieces
2. 2 Works Simultaneously
3. Proven Safety Record
4. No Downtime and No Side Effects
5. Temperature:-14°C-15°C
6. Two Handpieces Size:15×6CM/18×8CM



Slender waist

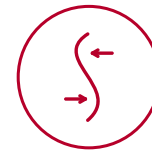

Perfect body



Skin tighten

THE HANDLE



Cryo Handle
Size: 18*8CM



Cryo Handle
Size: 15*6CM



High Frequency Antiaging Machine

DM-511

Amazing Tool To Make Young Forever.



Wrinkle removal



Anti-aging



Skin tightening



ADVANTAGES

- 1.** Safe, comfortable, easy to operate
- 2.** Nano - ceramics handle
- 3.** Suitable for all kinds of skin
- 4.** Bipolar circuit, radio frequency transmission proprietary technology

THE HANDLE



SPECIFICATION

Type: High frequency

Frequency: 10MHZ

Depth: Dermis

Energy: 1-32J

Time setting: 1-60min

Crest Voltage: 1800V

Power: 350W

DM-9006

Nd Yag Laser Tattoo Removal

Opportunity Knocks For All Beauty Salons !

ADVANTAGES

1. Good looking with color touch screen
2. Three laser heads: 532nm, 1064nm, 1320nm
3. Multifunction, able to solve all pigment problems.
4. Durable, 500,000 laser shots



Skin whitening



Pigment removal



Skin rejuvenation

THE HANDLE



SPECIFICATION

Laser type: Nd:YAG Laser

Cooling system: Closed-off water circulation+air

Power: 1000W

Voltage: 110-240V 60/50HZ

Laser wavelength: 1064nm/532nm/1320nm

Energy: 1-50

Frequency: 1-6HZ

G.W.: 31KG

Meas: 60x62x90cm



OPT SHR Machine

DM-9011

One Machine, Dozen Therapies, One Enough !



Painless
hair removal



Pigment removal



Skin rejuvenation



ADVANTAGES

1. No pain, No downtime
2. 100% Safe and Comfortable
3. In Motion technology, swift operation
4. Client data management system
5. Client therapy printing system
6. Britain Lamp has at least 200000/shots
7. Strong Semiconductor cooling
8. 10 hours non-stop working

THE HANDLE



HR handle (15x50mm)

SR handle (12x30mm)

SPECIFICATION

Power: 3000W

Voltage: 110V~240V, 50Hz/60Hz

Spot size: HR (15x50mm) SR (12x30mm)

Energy: 1~50J/CM²

Wavelength: HR (640nm) SR (530nm)

Cooling System: Water+ Air + Semiconductor cooling system

Screen: 10.4 inch color touch screen

G.W.: 68Kgs

Meas.: 68x70x130cm

DM-9011T

Portable SHR Machine

Affordable Device To Solve All Skin Problems!

ADVANTAGES

- 1.** No pain, No downtime
- 2.** 100% Safe and Comfortable
- 3.** In Motion technology, Swift
- 4.** Big Spot 15x50mm for hair removal
- 5.** Britain Lamp guarantees at least 200000/shots
- 6.** Portable Design, good for salon/beauty clinic



No Pain
Hair Removal



Pigment removal



Skin
rejuvenation

THE HANDLE



SR handle (12x30mm)



HR handle (15x50mm)

SPECIFICATION

Power: 1500W

Voltage: 110V~240V, 50Hz/60Hz

Spot size: HR (15x50mm) SR (12x30mm)

Energy: 1~50J/CM2

Wavelength: HR (640nm) SR (530nm)

Cooling System: Water+ Air + Semiconductor cooling system

Screen: 8 inch color touch screen

G.W.: 38Kgs

Meas.: 56x74x58cm



SHR Laser RF Beauty Machine

DM-9002C

One Machine Solves Various Skin Problems.



Permanent hair removal



Tattoo removal



Skin lift



ADVANTAGES

- 1.** Multifunctional: SHR + Laser + RF
- 2.** A wide range of treatments
- 3.** High quality Britain imported SHR Lamp, long service life with stable energy
- 4.** Perfect cooling system: water+air+semiconductor cooling
- 5.** Exquisite design, High-end appearance

THE HANDLE



SHR Handle(15*50mm)

RF Handle



Laser Handle

SPECIFICATION

Power: 2000W

Voltage: 110V-240V, 50HZ/60HZ

Screen: 10.4 inch color touch screen

Cooling system: Wind+Water+Semiconductor cooling

SHR Energy: 1-50J/CM2

SHR Spotsize: 15x50mm

SHR Filters: 480nm, 530nm, 640nm

SHR Shots: 100,000 shots

Laser wavelengths: 532nm, 1064nm, 1320nm

Laser shots: 200,000 shots

RF Frequency: 10MHZ

Packing size: 65x73x136cm

G.W. : 68kg

DM-9011D

One Handle SHR Machine

An Affordable Device To Solve All Skin Problems!

ADVANTAGES

- 1.** Non-invasive technology, no pain, no adverse reactions and side effects
- 2.** Good effect with positive feedback
- 3.** 100% Safe and comfortable
- 4.** Britain lamp has at least 200,000 shot
- 5.** Strong air+water+semiconductor cooling system
- 6.** 10 hours non-stop working



Permanent hair removal



Skin rejuvenation



Pigment removal

THE HANDLE



SHR Handle with 3 filters
(480nm, 530nm, 640nm)



SPECIFICATION

Power: 2000W

Voltage: 110V~240V, 50HZ/60HZ

Screen: 10.4 inch color touch screen

Cooling system: Wind+Water cooling system

Energy: 1-50J/CM2

Spot size: 12x30mm or 15x50mm

Filters: 480nm, 530nm, 640nm

Shots: 200,000 shots

Packing Size: 60x63x122cm

G.W.: 58kg



Fractional Co2 Laser Machine

DM-802

Fractional + Co2 Surgery + Vagina Tighten



Vagina care



Scar removal



Stretch mark removal



ADVANTAGES

1. 3 in 1 system, easy and convenient for operation
2. Advanced three - dimensional lattice technology
3. excellent 7 articular optical-arm, easy operated and greatly reduces the energy loss
4. Have a variety scan modes and scan shapes
5. 3 vagina treatment probes for different part;
6. Minimal side effects and no down time
7. 8.4 inch real LCD color touch screen, most humanized software control.

THE HANDLE



SPECIFICATION

Laser power: 40W

Output power: 500W

Wavelength: 10600nm

Working mode: continuous operation

Spotsize: 0.02~0.05mm²

Scan scope: MAX 20mm×20mm

Scanning Speed: More than 10m/s

Scanning Mode: Random, Normal and Midsplit scan

Pulse width: 0.1~5.0ms

Distance: 0.1~2.6mm

Packing size: 61×52×126cm

G.W.: 58KG

DM-522

HIFU Face Lifting And Vagina Tightening Beauty Machine

One Machine Takes Care Of The Most Secret Garden For Women.

ADVANTAGES

1. 360°C rotation emission
2. Precise depth adjustment system
3. Obvious instant results tightening and lifting effect
4. Non-invasive, no downtime, no recovery time
5. 2 in1 Easy and convenient
6. Long effect lasting : One facial treatment, 2 years lasting; One vagina treatment, 6 months lasting



Face lift



Vaginal Tightening



Wrinkle removal

THE HANDLE



Handpiece for face



Handpiece for vagina

SPECIFICATION

Power: 150W

Voltage: 110V~240V, 50HZ/60HZ

Cartridges: 1.5mm, 3.0mm, 4.5mm(for face)
3.0mm, 4.5mm (for vagina)

Shots: 5000 shots/cartridges

Screen: 15 inch color touch screen

Packing Size: 61x44x70cm

G.W. : 21kg





DM-907
Cavitation RF Machine

Accessories

1. 4-polar RF
2. 2-polar RF with Vacuum
3. 80K Cavitation
4. 40K Cavitation
5. BIO



DM-908
V8 Extreme Shaping Machine

Accessories

1. 4-polar RF
2. 2-polar RF with Vacuum
3. 40K Cavitation
4. BIO
5. Ultrasonic for face



DM-909
650nm Diode Lipo Laser Machine

Accessories

1. 8 pads (6 big+ 2 small)
2. 10 pads (8 big+ 2 small)
3. 12 pads (8 big+ 4 small)
4. 14 pads (10 big+ 4 small)



DM-F611
4 In 1 Microdermabrasion Machine

Accessories

1. Ultrasound for face
2. Ultrasound for eye
3. Scrubber
4. Hot & cold hammer
5. Dermabrasion

OUR Certification



OUR Training



Packaging



EPE Foam inside Carton, Wooden, Aluminum case packing

Delivery



Air Cargo



By Sea



By Truck



After sales support

We offer user manual and Youtube operation video as your guidance.12 months for host machine, lifelong maintenance service.Well-trained engineers will offer you any technical support; any machine problem, will provide professional solution soon. Professional training team offers service in thousand of salons, beauty centres, clinics in China, and will provide reliable setting date reference and operation advice.



Operation Video



Online Service



User Manual

PAYMENT

The payment by T/T (Wire Transfer), Western Union, MoneyGram, Paypal Is acceptable.By Credit card is also workable with Trade Assurance order.

