



MEH  ME<sup>®</sup>

2019

# Glasstone®

## Glasstone® Shower Tray, Basin, Laundry Tub & Wall Panel

Glasstone® manufactures SMC/BMC, a composite material composed of resin, fiberglass, filler etc .It needs a 500~3000 tone compression machine with metal mould to press at 150~160°C. Glasstone® have a solid surface, high glossy, matte or stone effect finish for easy cleaning.

Glasstone® is used to make parts for planes ,trains、 cars、 machines etc, and have been used to make bath tub , shower tray, basin, laundry tub and wall panel in USA, Japan. Canada, Australia and Europe.

Glasstone® has a lighter and stronger design. Which will not twist. As it is press by metal mould, the size, angle, and line is copied in a very precise manner. Radius and the mold angle can be very small and precise. It is flat,colorful, no scratches, cost-effective. All of these make it much better than ceramic, polymarble and acrylic.

All Glasstone® bathroom products carry a 5-year guarantee.

SMC-Sheet Molding Compound

BMC-Bulk Molding Compound



Slate stone shower tray  
Classic shower base  
Wet-room forms  
Tile tray  
Vanity basin  
Counter basin  
Laundry tubs  
Panel & Skirt

# SLATE STONE SHOWER TRAY

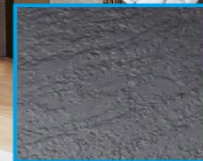
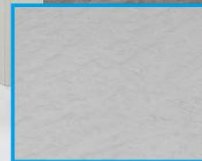
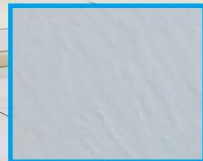



## 70ES SMC SHOWER TRAY

### SLATE STONE SHOWER TRAY

- SMC-sheet molding compound
- Light weight
- Nature stone effective
- Easy Installation
- Available in more colors
- Available in more sizes



Can be cut to size

#### ▲ GT-9070ES SMC SLATE STONE SHOWER TRAY

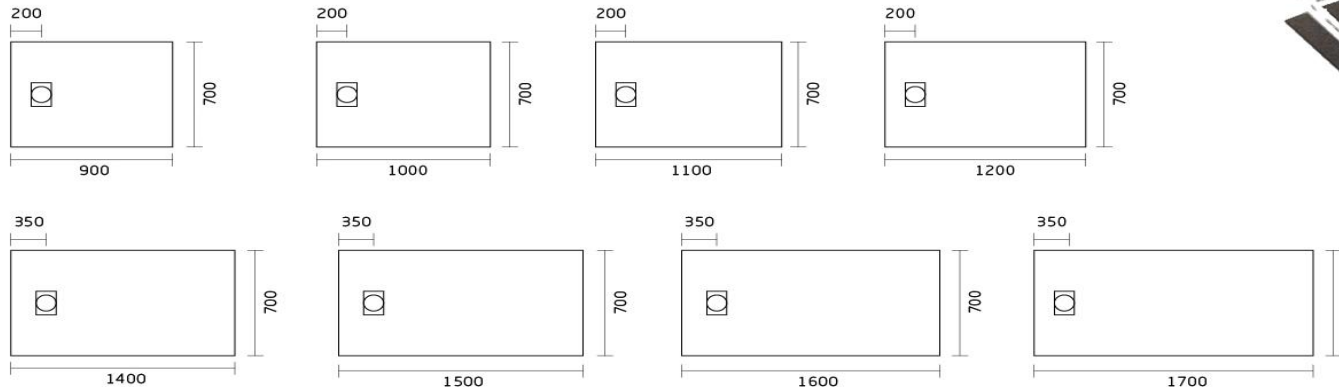

## 80ES SMC SHOWER TRAY

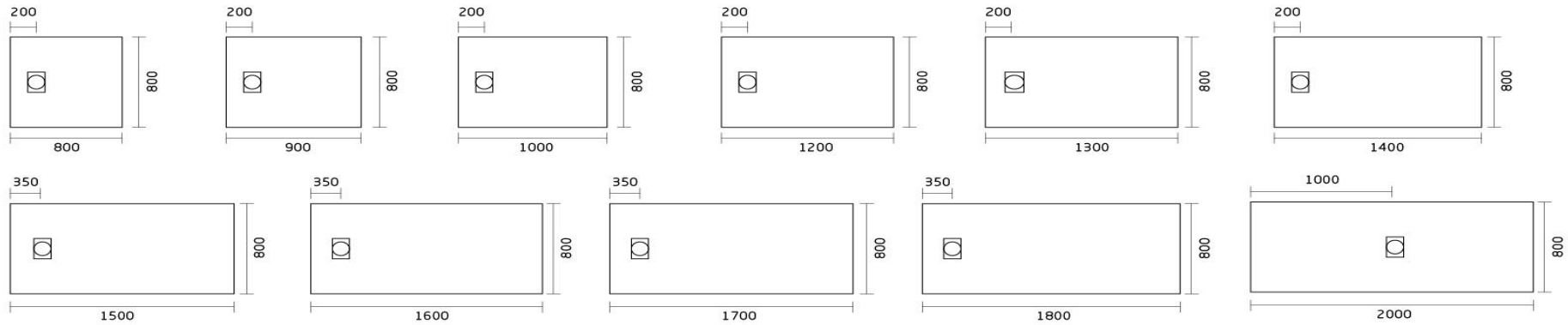

▲ GT-14080ES SMC SLATE STONE SHOWER TRAY

### SLATE STONE SHOWER TRAY

- SMC-sheet molding compound
- Light weight
- Nature stone effective
- Easy Installation
- Available in more colors
- Available in more sizes





## SHOWER PANEL & ACCESSORIES

### SKRITING BOARD

- SMC-sheet molding compound
- Light weight
- Nature stone effective
- Easy Installation
- Available in more colors
- Available in more sizes

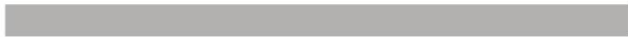

▲ SKRITING BOARD



Can be cut to size

## 90ES SMC SHOWER TRAY

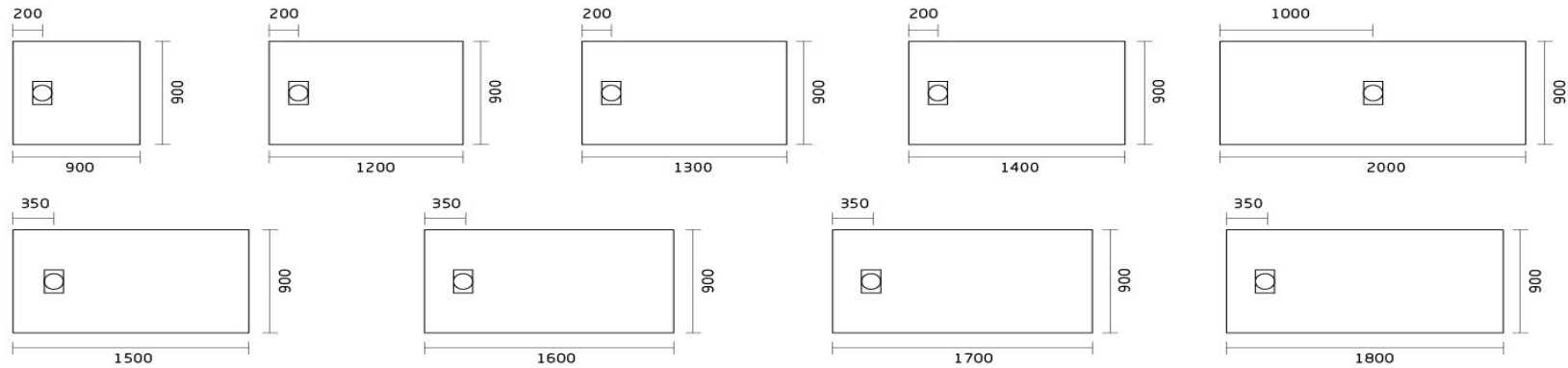

▲ GT-18090ES SMC SLATE STONE SHOWER TRAY

## SLATE STONE SHOWER TRAY

- SMC-sheet molding compound
- Light weight
- Nature stone effective
- Easy Installation
- Available in more colors
- Available in more sizes





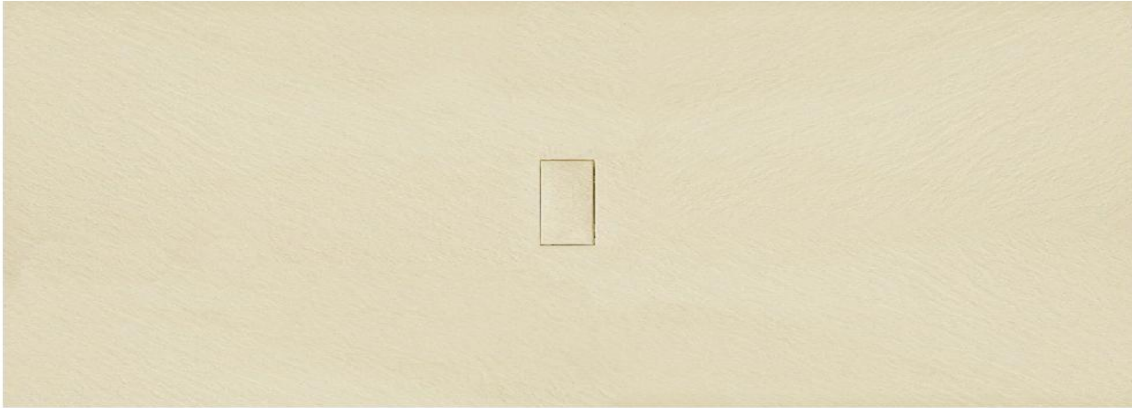

Can be cut to size

▲ GT-200100ES SMC SLATE STONE SHOWER TRAY

100ES SMC SHOWER TRAY

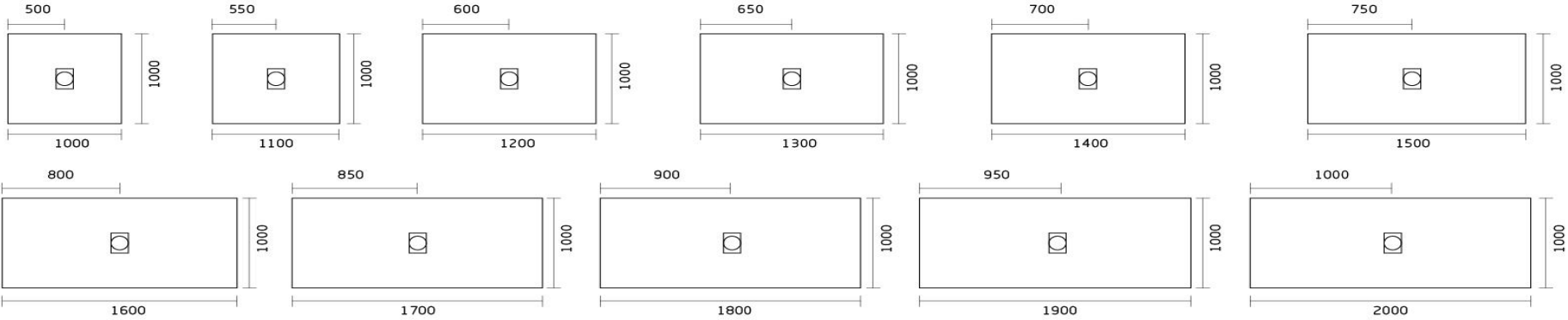

## STONE EFFECT

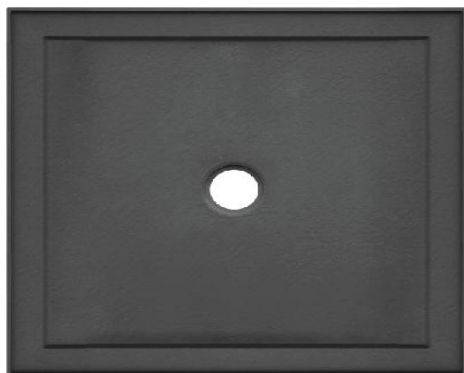

▲ GT-9090ACS SMC SLATE STONE SHOWER TRAY



▲ GT9090RES SMC SLATE STONE SHOWER TRAY



▲ GT-12090AUS SMC SLATE STONE SHOWER TRAY

### SLATE STONE SHOWER TRAY

- SMC-sheet molding compound
- Light weight
- Nature stone effective
- Easy Installation
- Available in more colors
- Available in more sizes



MEH<sup>®</sup>OME

# CLASSIC SHOWER BASE

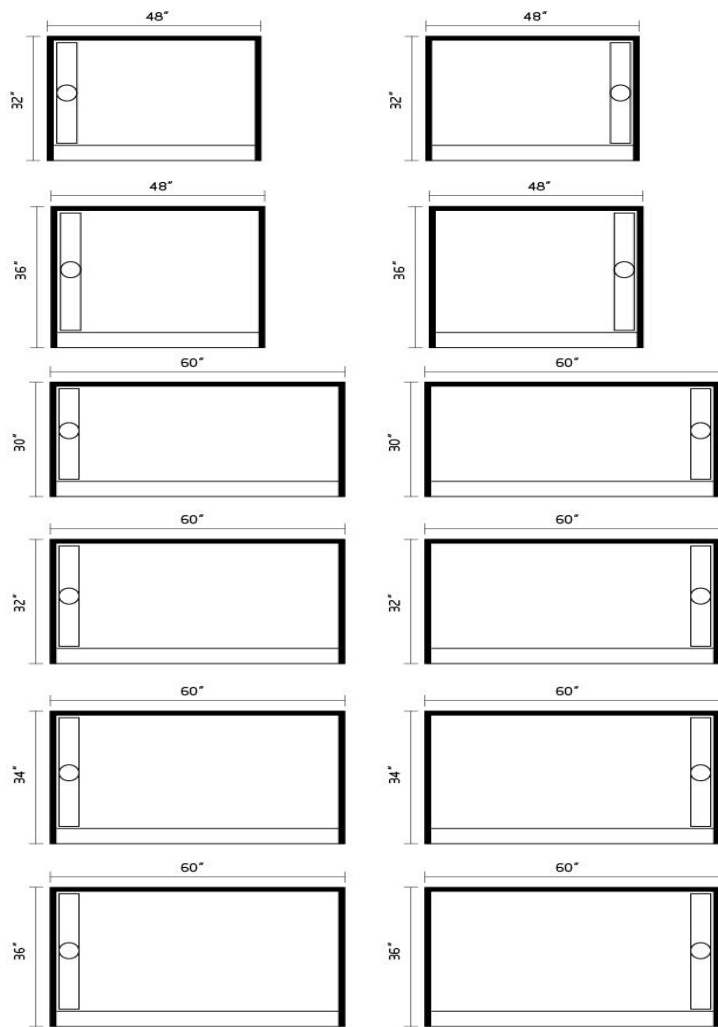

▲ GTB-6036L SMC SHOWER BASE





▲ GTC-6036L SMC SHOWER BASE



## SMC SHOWER TRAY

- SMC-sheet molding compound
- Self supporting
- Light weight
- Low profile
- Easy Installation
- Available in more sizes

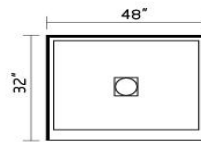
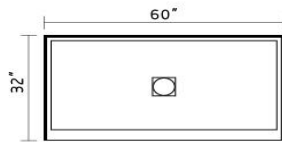
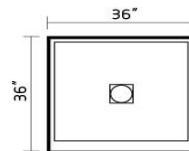
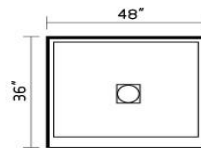
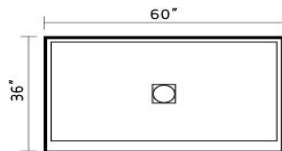

Easy  
Installation



Slip Resistant  
Texture



5 YEARS  
Warranty



Premium  
Quality





▲ GTA-6032L SMC SHOWER BASE

## SMC SHOWER TRAY

- SMC-sheet molding compound
- Self supporting
- Light weight
- Low profile
- Easy Installation
- Available in more sizes

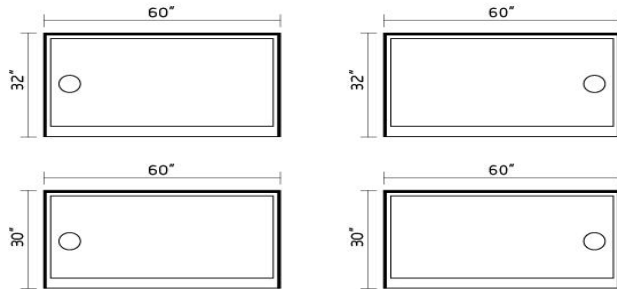

**REPLACE THE BATH TUB  
SHOWER PAN**



# 70E CLASSIC SHOWER TRAY

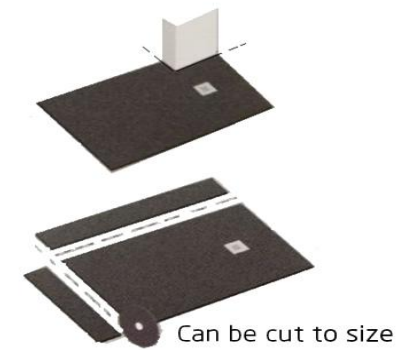
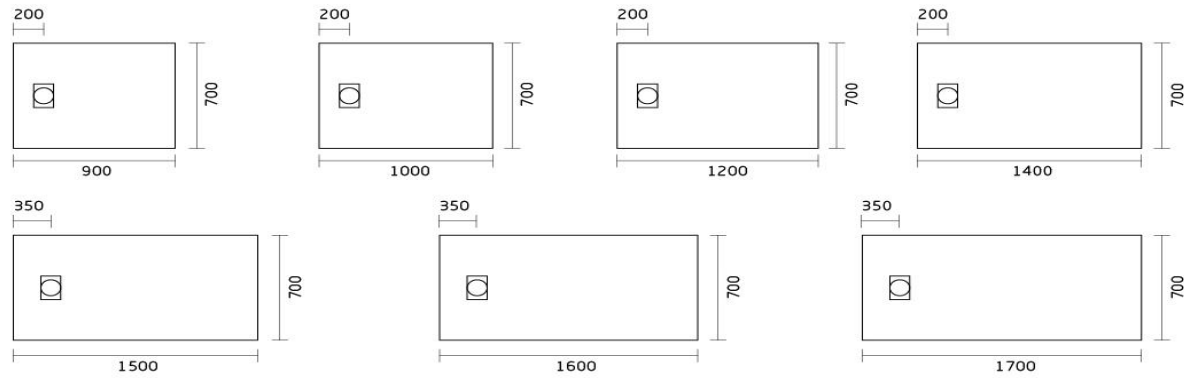

Can be cut to size



▲ GT-14070E SHOWER TRAY



- SMC-sheet molding compound
- Light weight
- Classic glossy finish
- Easy Installation
- Available in more colors
- Available in more sizes







▲ GT-9090RE SMC SHOWER TRAY



▲ GT-10080E SMC SHOWER TRAY

## 80E SMC SHOWER TRAY

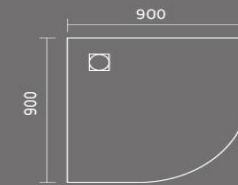
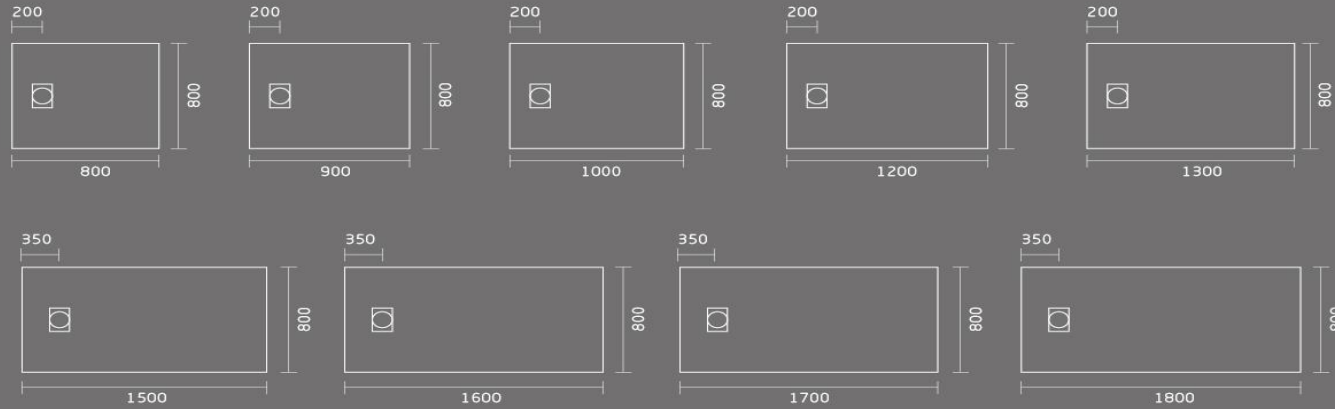

## 90E CLASSIC SHOWER TRAY

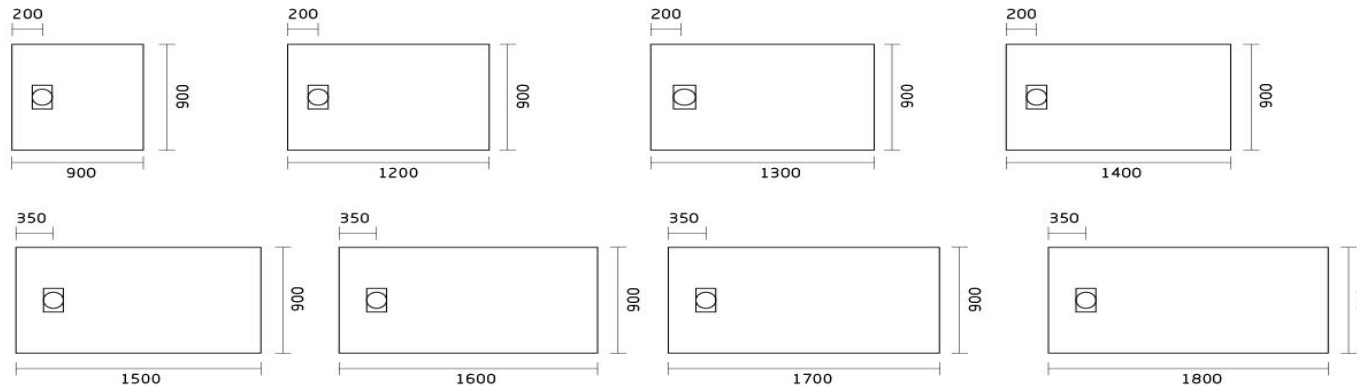

Can be cut to size

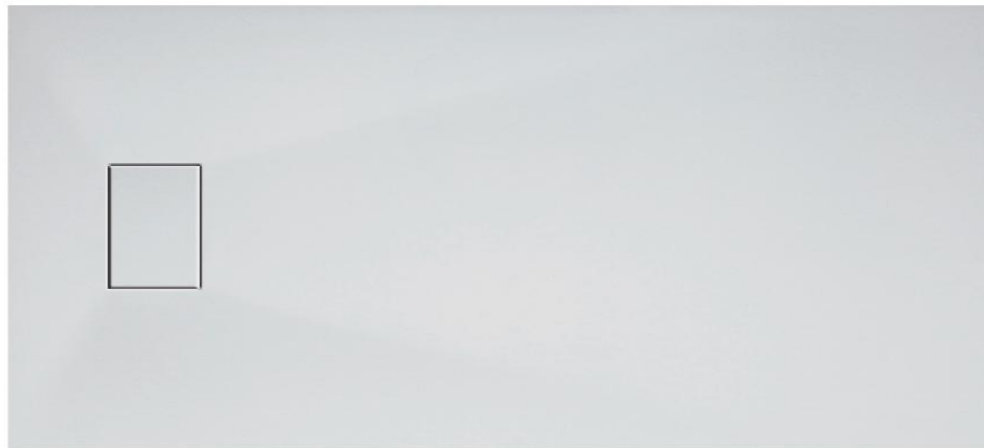

▲ GT-18090E SHOWER TRAY



- SMC-sheet molding compound
- Light weight
- Classic glossy finish
- Easy Installation
- Available in more colors
- Available in more sizes





▲ GT12090AU SMC SHOWER BASE

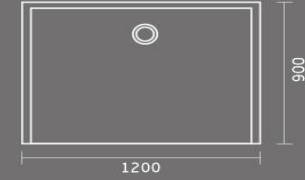
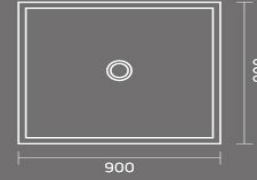
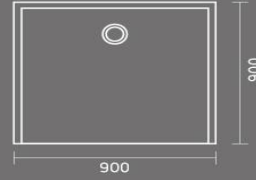

## SMC SHOWER TRAY



▲ GT9090AU SMC SHOWER BASE



▲ GT-9090AC SMC SHOWER BASE

- Sheet molding compound
- ABS white waste
- Low profile
- Self-supporting
- 9mm three sided tile flange
- Light weight
- Easy Installation
- Available in more sizes



▲ GT-12090AT SMC SHOWER BASE



▲ GT-9090AT SMC SHOWER BASE

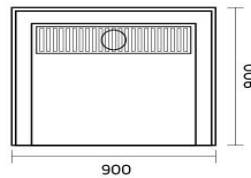
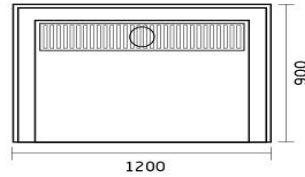

## SMC SHOWER TRAY

- Self supporting
- Light weight
- Low profile
- Easy Installation
- 9mm three sided tile flang
- Available in more colors
- Available in more sizes
- 304 stainless steel bracket



▲ GT-9090NC SMC SHOWER BASE

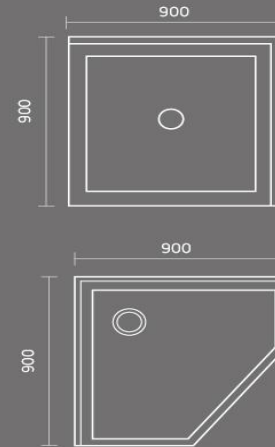

▲ GT-9090CN SMC SHOWER BASE



▲ GT9090AS SMC SHOWER BASE

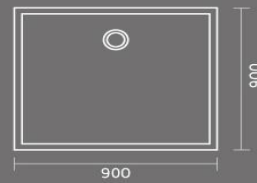

## SMC SHOWER TRAY

- Sheet molding compound
- ABS white waste
- Low profile
- Self-supporting
- Light weight
- Easy Installation
- Available in more sizes

# WET ROOM FORMS

Save You Time And Money

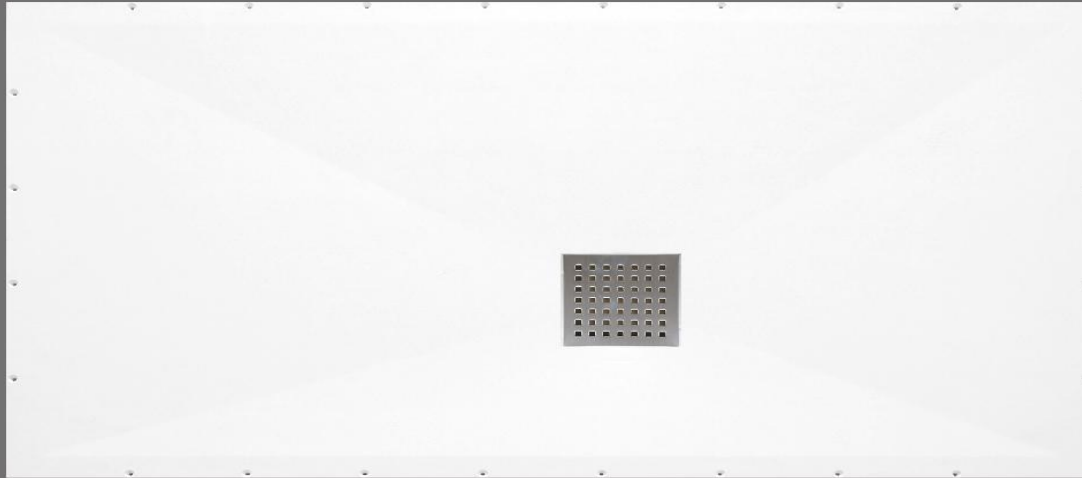

▲ WF-15082 SMC WET ROOM FORM

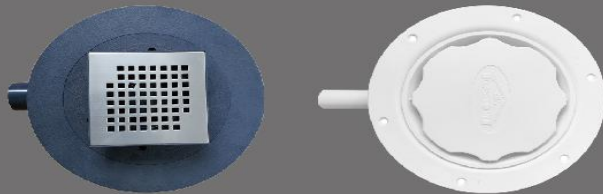

# WET ROOM FORMS

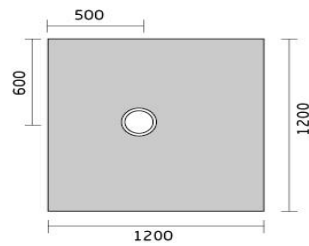
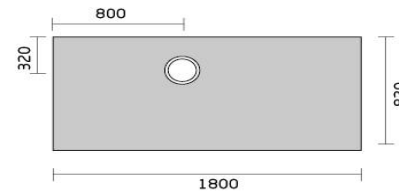
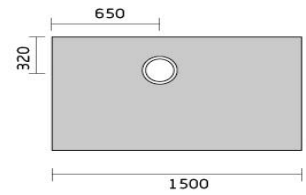
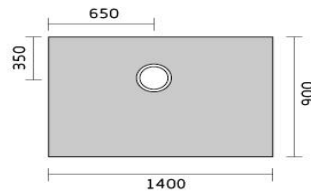
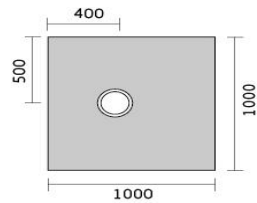
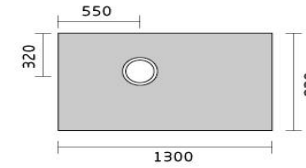
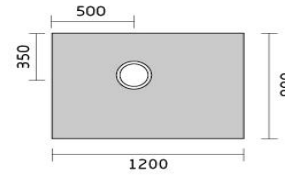
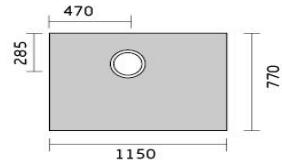
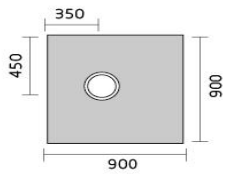

## Installation

### Timber

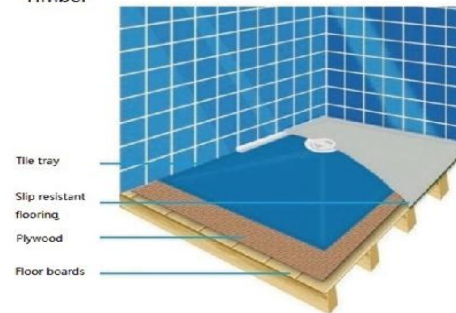

### Concrete

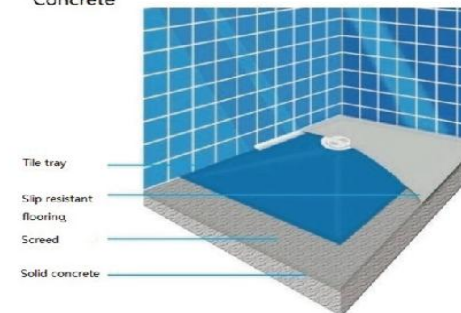

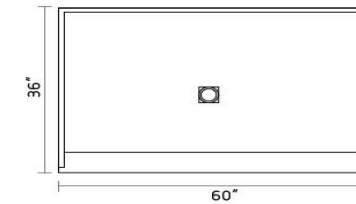
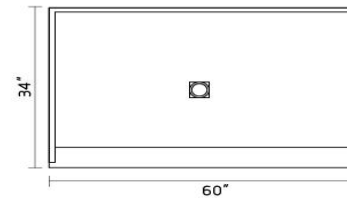
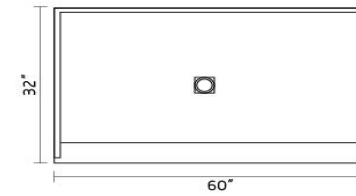
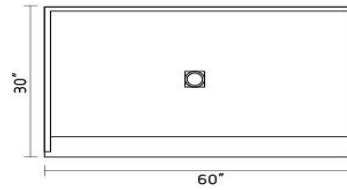
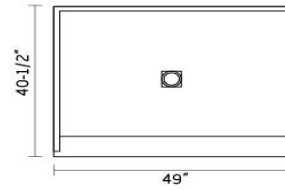
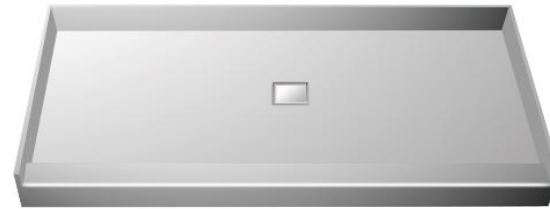

Easy  
Installation



Slip Resistant  
Texture



5 YEARS  
Warranty



Premium  
Quality





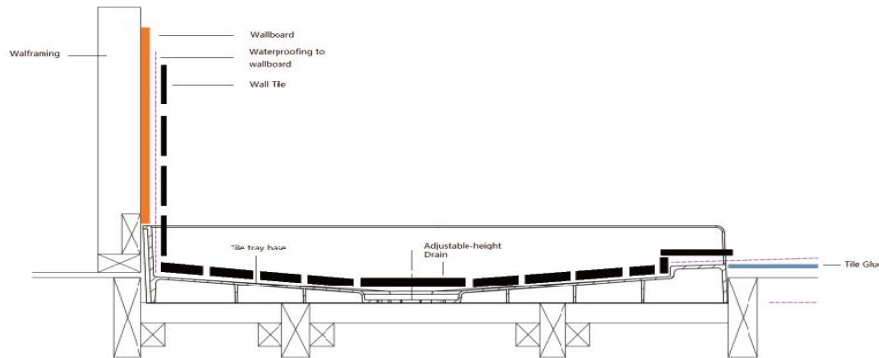
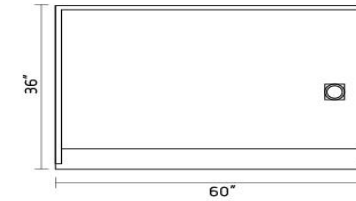
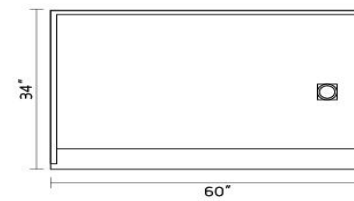
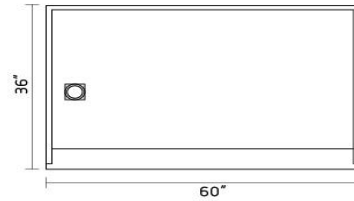
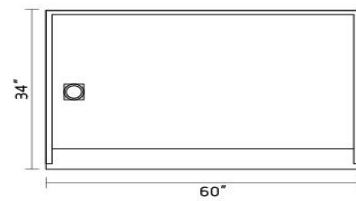
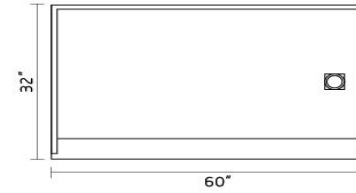
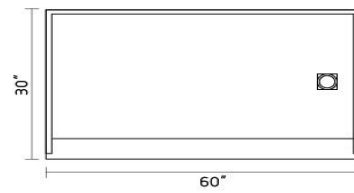
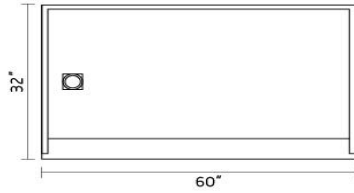
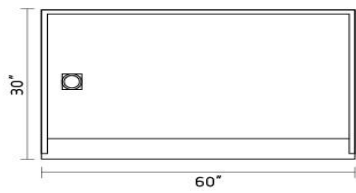

## SMC TILE TRAY SYSTEM

- Self supporting
- Light weight
- Low profile
- Easy Installation
- Can be recessed into the floor
- Available in more sizes



▲ TG9090A SMC TILE TRAY



▲ TG1000A SMC TILE TRAY

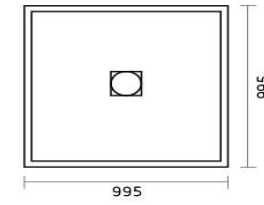
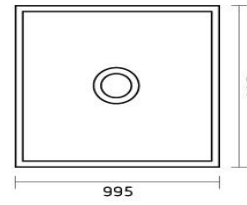
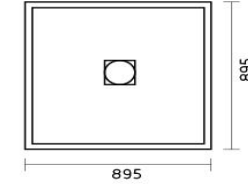
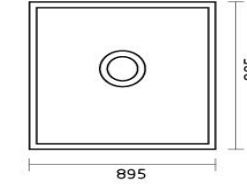

▲ TG9090C SMC TILE TRAY



▲ TG1000C SMC TILE TRAY



▲ TG12090C SMC TILE TRAY



▲ TG12090A SMC TILE TRAY



▲ TG9090B SMC TILE TRAY

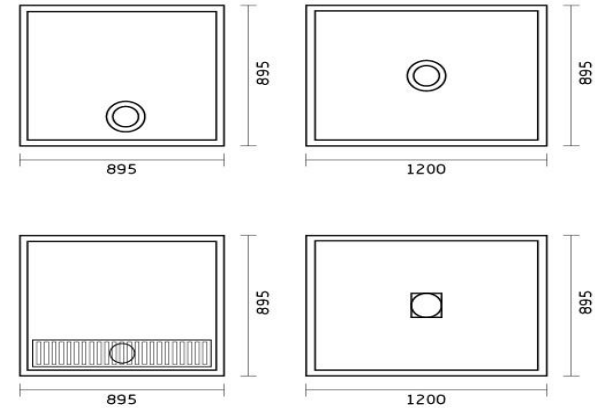

## SMC TILE TRAY

- Self supporting
- Light weight
- Low profile
- Easy Installation
- 36mm 2,3,4 sided the flange
- Can be recessed into the floor
- Available in more sizes

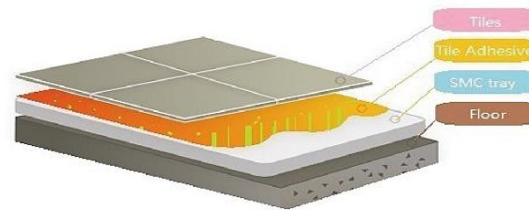

▲ TG9090D SMC TILE TRAY



27



▲ SP-1627



▲ SP-1639



▲ SN-1614



▲ SN-1620

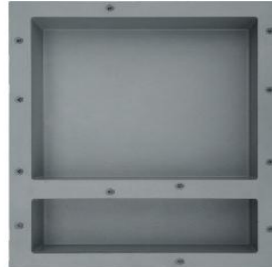

▲ SN-1620D



▲ SN-1605

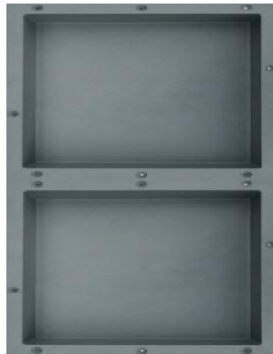

▲ Shower niches can be any combination

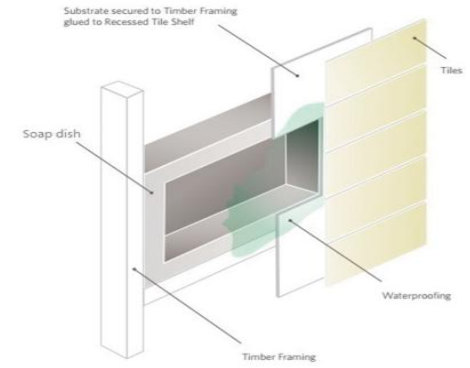

## SMC SHOWER NICHE

- Self supporting
- Light weight
- Can be recessed into the floor
- Available in more sizes
- Available in more combinations



# SLATE STONE VANITY BASIN



**5**  
Years Guarantee

**EN**  
14527

**CE**

**ISO**  
9001



▲ RG-9046 SLATE STONE VANITY BASIN

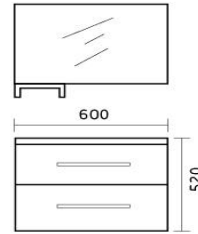

▲ RG-6046W  
2 Draws

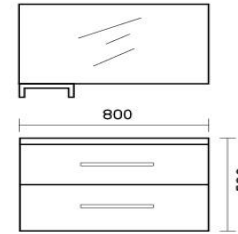

▲ RG-8046W  
2 Draws

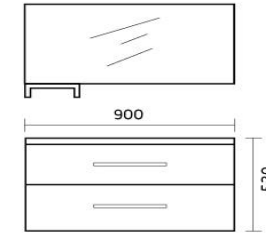

▲ RG-9046W  
4 Draws

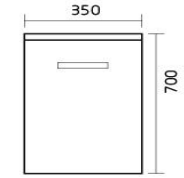

▲ TB - 09D  
1 Door Cabinet



▲ RG-6046



▲ RG-8046



▲ RG-9046

## ROYAL RANGE

### WALLHUNG VANITY UNIT WITH GLASSTONE TOP

- 2-pac polyurethane front
- Stand as king height
- Cam lock construction
- SMC / BMC VANTY TOP
- Available wall hung or with recessed toe kick
- Available MDF, plywood or chipboard
- Fully adjustable metal hinges
- Available 1 or 3 tap holes
- Available in more colors





▲ KG-9046 VANITY TOP

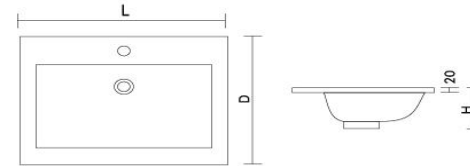

ITEM No	L:mm	D:mm	H:mm	NW.kgs	CBMS	REMARK
KG6046	600	460	145	4.2	0.056	SMC/BMC
KG7546	750	460	145	5.3	0.066	SMC/BMC
KG8046	800	460	145	5.9	0.070	SMC/BMC
KG9046	900	460	145	6.2	0.082	SMC/BMC

## KING RANG SMC BASIN

### PROMOTION VANITY WITH CLASSIC SMC BASIN

- Glasstone (SMC/BMC) basin
- Available 1 or 3 tap hole(s)
- Stand as king height
- Cam lock construction
- Available in more colors

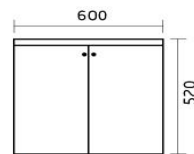
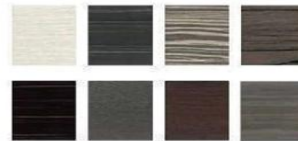

▲ KG-6046W  
2 Doors Vanity  
Wallhung

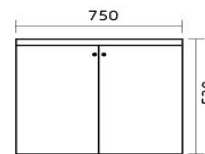

▲ KG-7546W  
2 Doors Vanity  
Wallhung

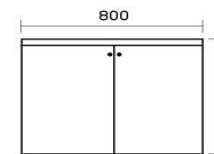

▲ KG-8046W  
2 Doors Vanity  
Wallhung

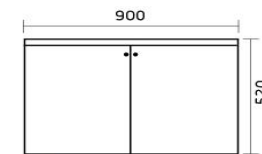

▲ KG-9046W  
2 Doors Vanity  
Wallhung



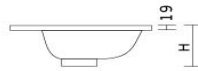
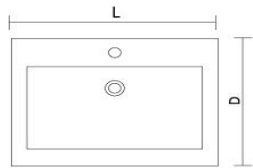

ITEM No	L:mm	D:mm	H:mm	NW.kgs	CBMS	REMARK
UG-1917	482	432	190			SMC/BMC
UG-2519	635	482	203			SMC/BMC
UG-3119	787	482	203			SMC/BMC
UG-3719	940	482	203			SMC/BMC



## UNIK RANG



- 2-pac polyurethane front
- Stand as king height
- Cam lock construction
- SMC/BMC BASIN
- Available wall hung or with recessed toe kick
- Available MDF,plywood or chipboard
- Fully adjustable metal hinges
- Available shelf
- Available 1 or 3 tap holes
- Available left or right hand drawers
- Available in more colors



▲ UG-3722 VANITY TOP

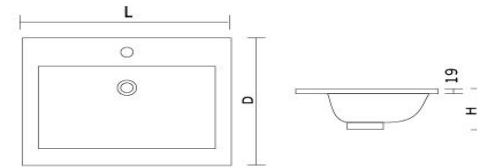

ITEM No	L:mm	D:mm	H:mm	NW:kgs	CBMS	REMARK
UG-2522	635	559	203			SMC/BMC
UG-3122	787	559	203			SMC/BMC
UG-3722	940	559	203			SMC/BMC
UG-4922	1244	559	203			SMC/BMC

## UNIK RANG SMC BASIN

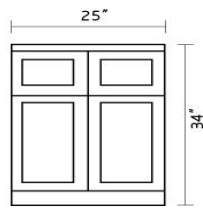

▲ U2522  
2 Doors Vanity

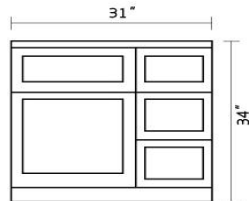

▲ U3122  
1 Door 3 Draws Vanity

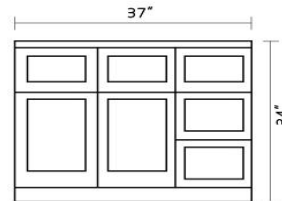

▲ U3722  
2 Doors 3 Draws Vanity

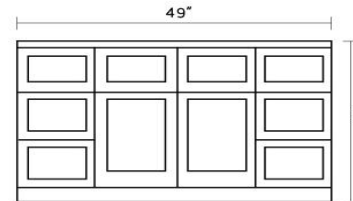

▲ U4922  
2 Doors 6 Draws Vanity

- SMC/BMC BASIN
- Stand as king height
- Cam lock construction
- Available wall hung or with recessed toe kick
- Available MDF, plywood or chipboard
- Fully adjustable metal hinges
- Available shelf
- Available 1 or 3 tap holes
- Available left or right hand drawers
- Available in more colors





▲ MINI 4022B VANTY TOP

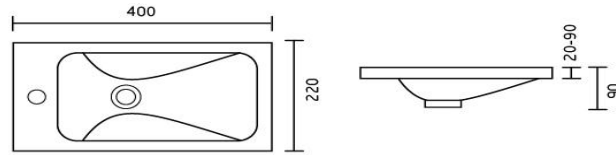

ITEM No	L-mm	D-mm	H-mm	N.W kgs	CBMS	REMARK
MN4022B	400	220	90	2.0	0.01	SMC/BMC



▲ MINI 4022A VANTY TOP

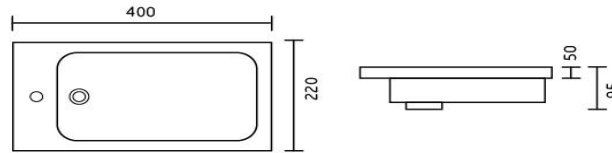

ITEM No	L-mm	D-mm	H-mm	N.W kgs	CBMS	REMARK
MN4022A	400	220	95	2.0	0.01	SMC/BMC

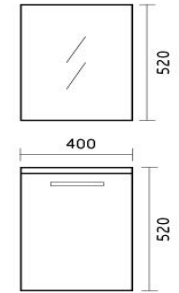

▲ MINI 4022W  
1 Door  
Wallhung Vanity

## MINI SMC BASIN

- Glasstone (SMC/BMC) basin
- 1 tap hole
- Cam lock construction
- Available wall hung or with recessed toe kick
- Available MDF, plywood or chipboard
- Fully adjustable metal hinges
- Available shelf
- Available left or right hand drawers
- Available in more colors



▲ MINI 4022  
1 Door Vanity



▲ LT-2522 LAUNDRY TUB



▲ LT-2822 LAUNDRY TUB

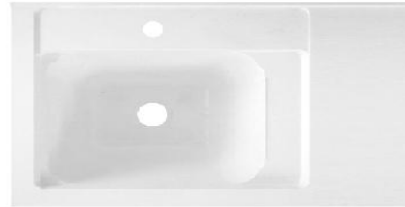

▲ LT-3022 LAUNDRY TUB

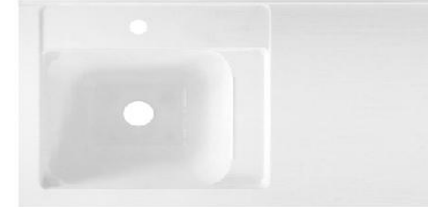

▲ LT-3622 LAUNDRY TUB

## SMC LAUNDRY SINK

- Glasstone (SMC/BMC) basin
- Available 1 or 3 tap holes
- Available in more colors
- Available in more sizes

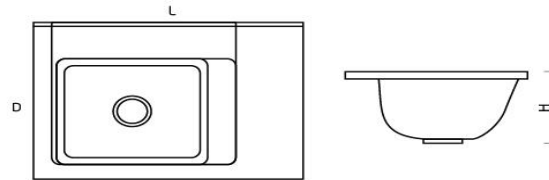

ITEM No	L.mm	D.mm	H.mm	NW.kgs	CBMS	REMARK
LT-2522	635	558	370			SMC/BMC
LT-2822	711	558	370			SMC/BMC
LT-3022	762	558	370			SMC/BMC
LT-3222	812	558	370			SMC/BMC
LT-3422	863	558	370			SMC/BMC
LT-3622	914	558	370			SMC/BMC



▲ 2522 LAUNDRY SET



▲ 3222 LAUNDRY SET



▲ 3622 LAUNDRY SET





▲ LT-5360R LAUNDRY TUB

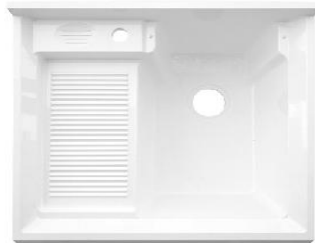

▲ LT-6360R LAUNDRY TUB



▲ LT-7360R LAUNDRY TUB



▲ LT-8060R LAUNDRY TUB

# GLASSTONE®

## VANITY TOPS & LAUNDRY TUBS

- Solid surface will not wear away
- Coordinates with Glasstone sink
- Easily accommodates all daucet styles
- Acetone will not damage surface
- Hot curling Irons will not damage surface
- Low profile and light
- Bigger size will not twist



▲ LT-12060R LAUNDRY TUB



▲ LT-2122B LAUNDRY TYB

## SMC LAUNDAAY TUB

- Glasstone (SMC/BMC) laundry tub
- Available 1 tap hole
- Available in more colors

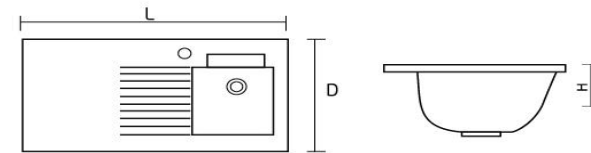

ITEM No	L:mm	D:mm	H:mm	NW.kgs	CBMS	REMARK
LT-5360R	530	600	220			SMC/BMC
LT-6360R	630	600	220			SMC/BMC
LT-7360R	730	600	220			SMC/BMC
LT-8060R	800	600	220			SMC/BMC
LT-10060R	1000	600	220			SMC/BMC
LT-11060R	1100	600	220			SMC/BMC
LT-12060R	1200	600	220			SMC/BMC
LT-10060L	1000	600	220			SMC/BMC
LT-11060L	1100	600	220			SMC/BMC
LT-12060L	1200	600	220			SMC/BMC

**OEM  
COUNTER BASIN  
UNDER COUNTER BASIN  
VANITY TOP  
SINK  
TUB**





## GLASSTONE®

- Solid surface will not wear away
- Acetone will not damage surface
- Hot curling irons will not damage surface
- Bigger size will not twist



## OEM SMC BASIN & TOP

- Glasstone (SMC/BMC) basin & vanity top
- Available 1 tap hole
- Available in more colors





**OEM WALLHUNG BASIN**





## GLASSTONE®

- Solid surface will not wear away
- Acetone will not damage surface
- Hot curling Irons will not damage surface
- Bigger size will not twist



## OEM WALL-HUNG BASIN

- Glasstone (SMC/BMC) wallhung basin
- Available 1 tap hole
- Available in more colors



WET-ROOM  
WALL PANEL

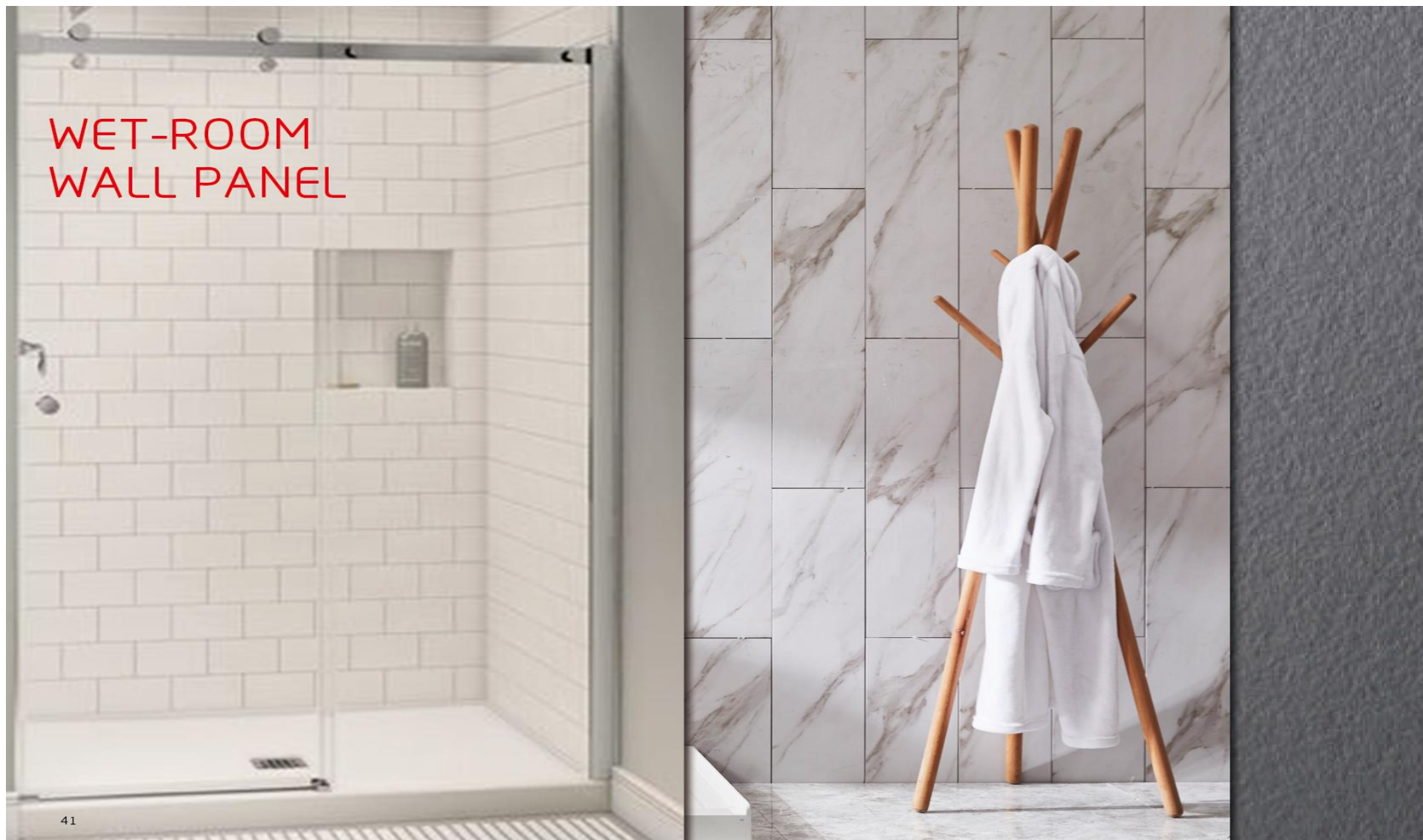

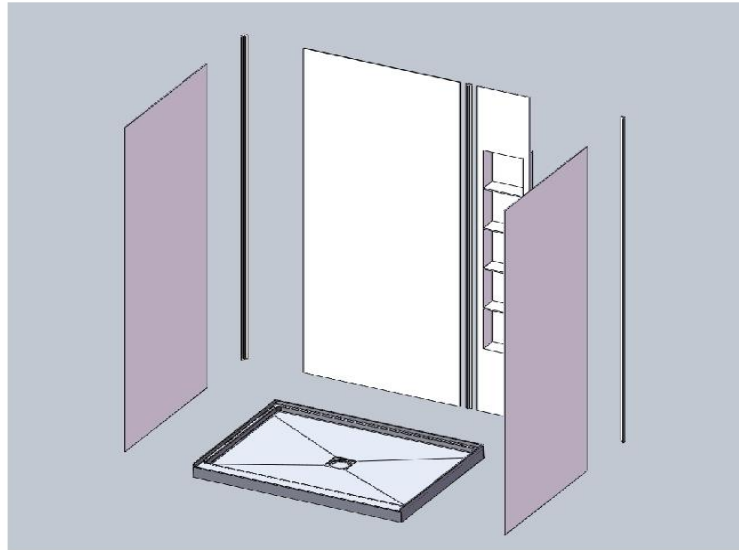
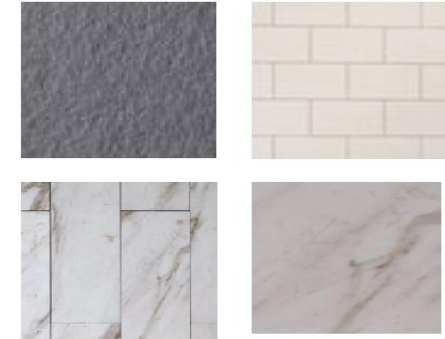
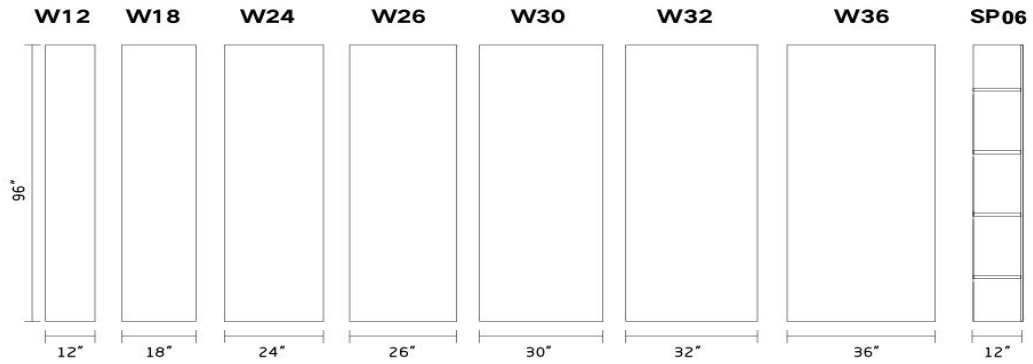

## WET-ROOM WALL PANEL

### TUB/SHOWER SURROUND INCLUDES

- One back panel
- Two side panels

### TUB/SHOWER SURROUND

#### MATERIAL:

Introsul simulated tile shower surrounds are manufactured from SMC - sheet molding compound

#### INSTALLATION:

Simulated shower surrounds should be installed over moisture-resistant wall board or sound ceramic tile. To arrange for a trained professional to install your simulated tileshower surrounds, call your local sales representative.



Easy  
Installation



Slip Resistant  
Texture



5 YEARS  
Warranty



Premium  
Quality





MAKING YOUR SPACE WORK FOR YOU...

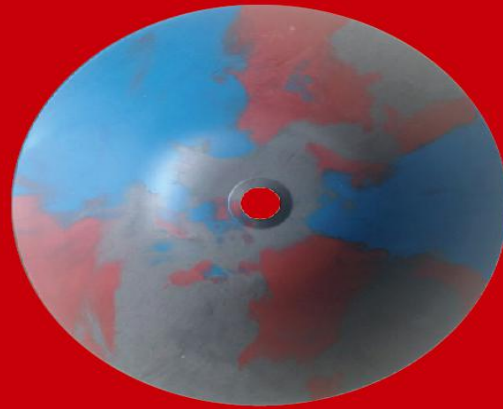

## JIANGSU MEHOME INDUSTRIAL CO.,LTD

江苏省宿迁市泗洪经济开发区长江西路40号  
ADD: NO 40 Changjiang West Road, Sihong Industrial zone  
Suqian City 223900, Jiangsu PRV, China  
◆ TEL: +86 527 89882908  
◆ E-mail: myglasstone@126.com  
◆ www.mehome.diytrade.com  
◆ www.myglasstone.com