

Ergonomic
Products & Solutions



MEGATRON
bring health to your life

ABOUT US

Megatron (Changzhou) Electronic Technologies Co.,Ltd. is located in Changzhou, Jiangsu province, was started from automation equipment manufacturing. Now Megatron have 15,000m² workshop, 85 staffs, including 22 technicians. "Bring health to your life" is our motto, with which we aim to optimize the workaday life of our clients by ergonomic products and solutions. We want to try our best to meet clients' demands by making our products unified, optimized and at low cost.

We consistently providing the right ergonomic products at the right price. We focus on producing high-quality and sustainable products. We have been providing clients in USA and west Europe with ergonomic products and solutions since 2009. Utilise our experience, Clients repeatedly tell us that we understand their vision perfectly.

Our vision is to make Megatron a brand represents value and confidence. We provide every service you need, from products design to delivery and repair. We also provide you with the assurance that our well trained technician will be with you from start to finish.

Welcome to be our partner! Let's trust each other and work together to achieve great success!

关于我们

美嘉创（常州）电子科技有限公司座落于江苏常州，公司从2009年做自动化设备起步，目前拥有厂房15,000平方米，员工85名，其中技术及研发人员22名。“为您带来健康”是我们的座右铭，为此我们致力于用人体工学产品和解决方案来为我们的客户优化工作环境。我们将尽可能的通过整合功能，优化细节和降低成本来满足客户的需求。

我们持续的用正确的价格来提供正确的人体工学产品。我们专注于生产高品质、可持续的产品，从2009年起，我们已经开始为美国和欧洲的客户的人体工学产品。基于我们丰富的经验，客户不断的称赞我们能理解他们的理念。

我们的理念是把美嘉创做成一个代表价值和信心的品牌。我们提供您所需的所有服务，从产品设计到运输到维修。我们同时向您保证我们受过良好训练的技术人员将持续为您待命。

欢迎成为我们的合作伙伴！让我们保持互信，共同合作，一起成功！

MEGATRON
bring health to your life

Why do we choose electric height adjustable desk?

为什么选择电动升降桌？

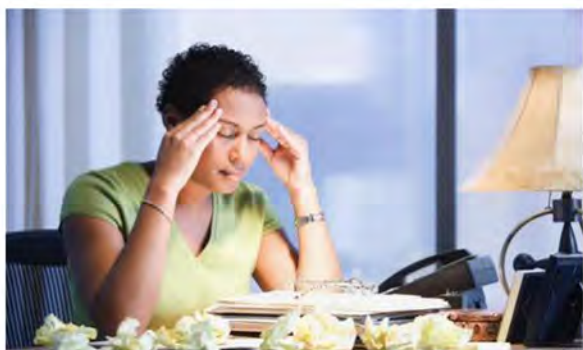

Sitting too long has proved to be harmful to your health, if you are suffering from:

- pain in the back and waist
- cervical disease
- hypomnesia
- inattention

You've been sitting too long!

Stand up and change posture!

久坐已被证明有损健康，如您正遭受腰颈肩疾病、记忆力减退、注意力分散等症状，表明您坐的时间太久了！赶紧站起来调整姿势吧！

Choose Megatron electric height adjustable desk to help you work standing!





Features 产品特点

- Stable
- Low operating noise
- Anti-collision stop build in
- Anti-UV powder coating,prolong lifespan
- Exclusive software assures columns rise and fall synchronously
- 运行稳定
- 运行噪音低
- 内置防撞功能
- 抗紫外线涂装，延长使用寿命
- 独家软件确保立柱升降同步

Dual motors three segments electric height adjustable desk frame

双电机三节电动升降桌支架



TECHNICAL DATA

MJC-001

产品参数

Specification	双电机三节	Dual motor three segments
Speed	速度	30mm/s
Max Load	单腿承重	1000N/leg
Length 长	Min	1007mm (39.65inch)
	Max	1805mm (71.06inch)
Width 宽	W	575mm (22.60inch)
Height 高	min	593mm (23.35inch)
	max	1243mm (48.94inch)
Foot size	足部尺寸	700*70*20mm
Tube size	腿管尺寸	80X50mm 70X70mm
Duty cycle		10%, max 2min continuous use
Input voltage	输入电压	110V or 230V
Tube material	腿管材质	Steel
Operating temperature	运行温度	+5°C ~ +40°C
IP Grade	IP等级	IP20

Color 颜色 White 白色 Black 黑色 Gray 灰色



Optional crossbar 可选横杆

Layout 平面图

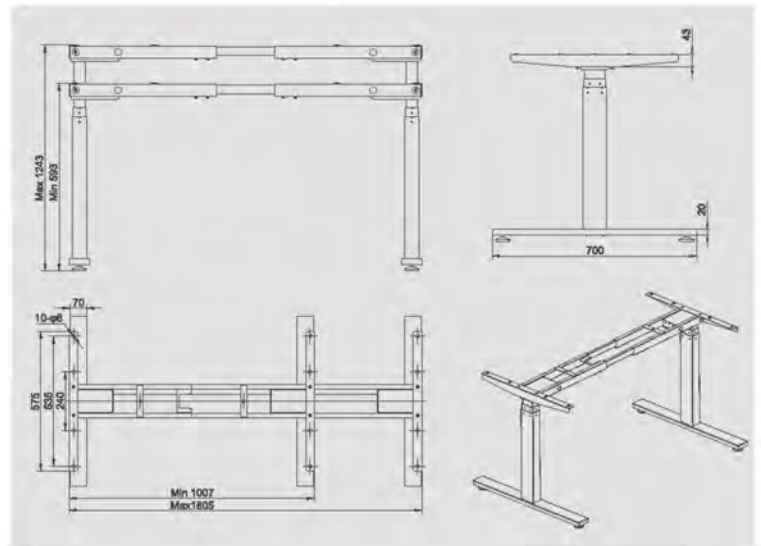

Optional colors 可选颜色



Gray 灰色



Black 黑色

Dual motors two segments electric height adjustable desk frame

双电机两节电动升降桌支架



TECHNICAL DATA

MJC-001A

产品参数

Specification	双电机两节	Dual motor two segments
Speed	速度	20mm/s
Max Load	单腿承重	1000N/leg
Length 长	Min	1007mm (39.65inch)
	Max	1805mm (71.06inch)
Width 宽	W	575mm (22.6inch)
Height 高	min	695mm (27.36inch)
	max	1195mm (47.05inch)
Foot size	足部尺寸	700*70*20mm
Tube size	腿管尺寸	80X50mm 70X70mm
Duty cycle		10%, max 2min continuous use
Input voltage	输入电压	110V or 230V
Tube material	腿管材质	Steel
Operating temperature	运行温度	+5°C~+40°C
IP Grade	IP等级	IP20
Color 颜色	White	白色
	Black	黑色
	Gray	灰色



Optional crossbar 可选横杆



Layout 平面图

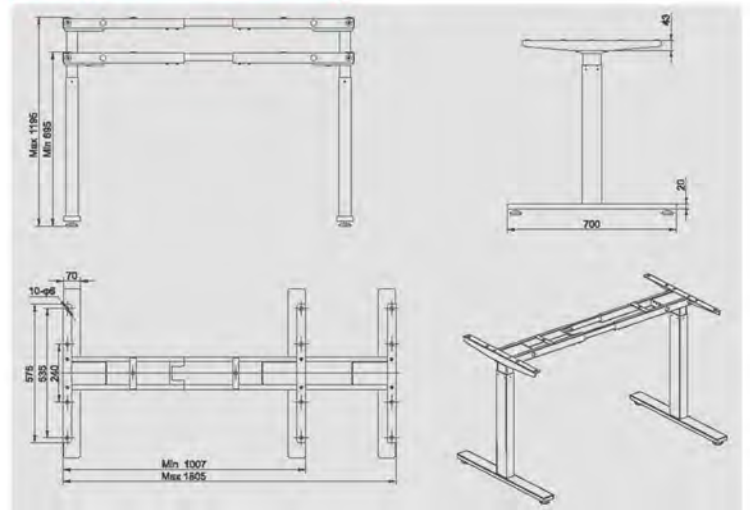

Optional color 可选颜色



Gray 灰色



Black 黑色

Three motors three segments electric height adjustable desk frame

三电机三节电动升降桌支架



TECHNICAL DATA		
MJC-002		
产品参数		
Specification	三电机三节	Three motors three segments
Speed	速度	30mm/s
Max Load	单腿承重	1000N/leg
Length 1 长	Min	1007mm (39.65inch)
	Max	1806mm (71.06inch)
Length 2 长	Min	1368mm (53.86inch)
	Max	2168mm (85.35inch)
Width 宽	W	575mm (22.60inch)
Height 高	min	593mm (23.35inch)
	max	1243mm (48.94inch)
Foot size	足部尺寸	700*70*20mm
Tube size	腿管尺寸	80X50mm 70X70mm
Duty cycle		10% max 2min continuous use
Input voltage	输入电压	110V or 230V
Tube material	腿管材质	Steel
Operating temperature	运行温度	+5°C ~ +40°C
IP Grade	IP等级	IP20
Color 颜色		<input type="checkbox"/> White 白色 <input checked="" type="checkbox"/> Black 黑色 <input type="checkbox"/> Gray 灰色

Reverse type: MJC-002R



Layout 平面图

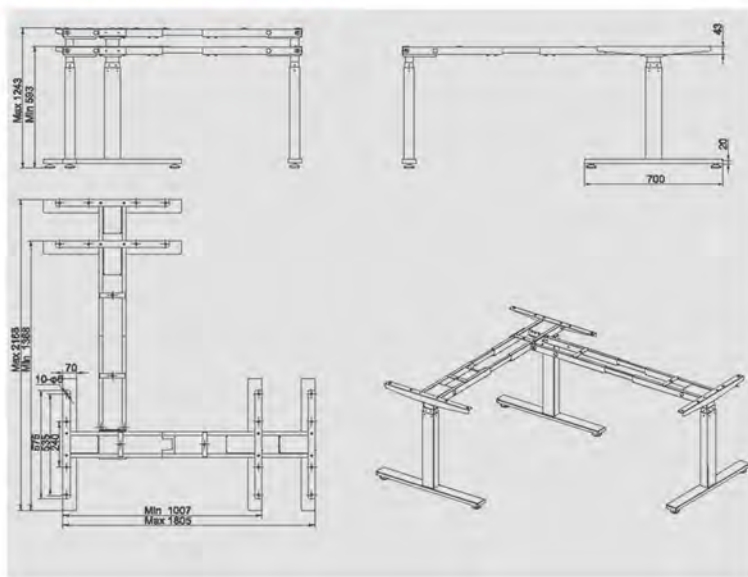

Optional colors 可选颜色



Gray 灰色



Black 黑色

Three motors two segments electric height adjustable desk frame

三电机两节电动升降桌支架



TECHNICAL DATA

MJC-002C

产品参数

Specification	三电机三节	Three motors three segments
Speed	速度	30mm/s
Max Load	单腿承重	1000N/leg
Length 1 长	Min	1007mm (39.65inch)
	Max	1805mm (71.06inch)
Length 2 长	Min	2014mm (79.29inch)
	Max	3614mm (142.28inch)
Width 宽	W	575mm (22.60inch)
	min	593mm (23.35inch)
Height 高	min	1243mm (48.94inch)
	max	1243mm (48.94inch)
Foot size	足部尺寸	700*70*20mm
Tube size	腿管尺寸	80X50mm 70X70mm
Duty cycle		10% max 2min continuous use
Input voltage	输入电压	110V or 230V
Tube material	腿管材质	Steel
Operating temperature	运行温度	+5°C ~ +40°C
IP Grade	IP等级	IP20
Color 颜色		White 白色 Black 黑色 Gray 灰色



120° angle

Angle adjustable 夹角可调

Layout 平面图



180° angle

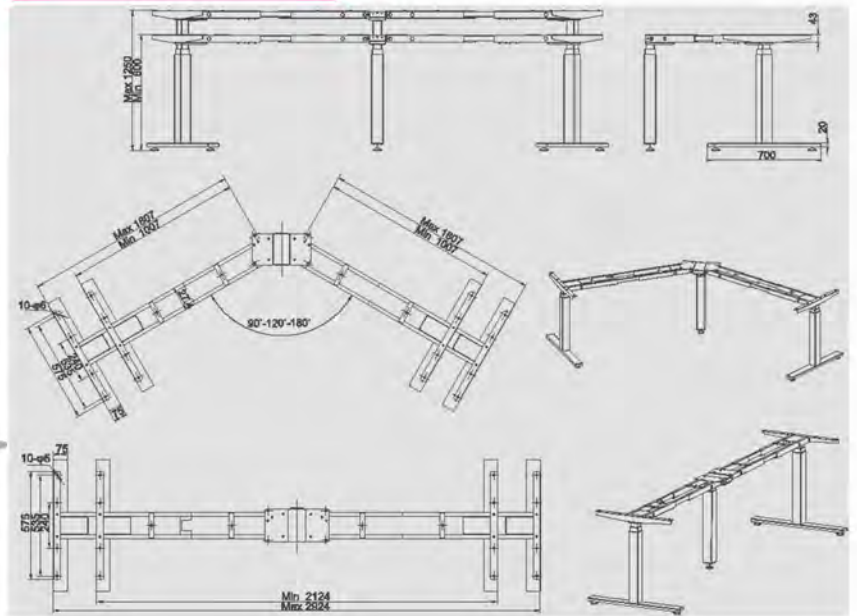

Three 120° desks combined

Optional colors 可选颜色



Gray 灰色



Black 黑色

Single motor three segments electric height adjustable desk

单电机三节电动升降桌

MJC-003A



MJC-003B



TECHNICAL DATA

MJC-003

产品参数

Specification	单电机三节	Single motor three segments
Speed	速度	30mm/s
Max Load	单腿承重	800N/leg
Height 高	min	635mm (23inch)
	max	1285mm (50.59inch)
Tube size	腿管尺寸	80X50mm 70X70mm
Duty cycle		10%, max. 2min continuous use
Input voltage	输入电压	110V or 230V
Tube material	腿管材质	Steel
Operating temperature	运行温度	-5C° ~ +40C°
IP Grade	IP等级	IP20
Color 颜色		<input type="checkbox"/> White 白色 <input checked="" type="checkbox"/> Black 黑色 <input type="checkbox"/> Gray 灰色

Layout 平面图

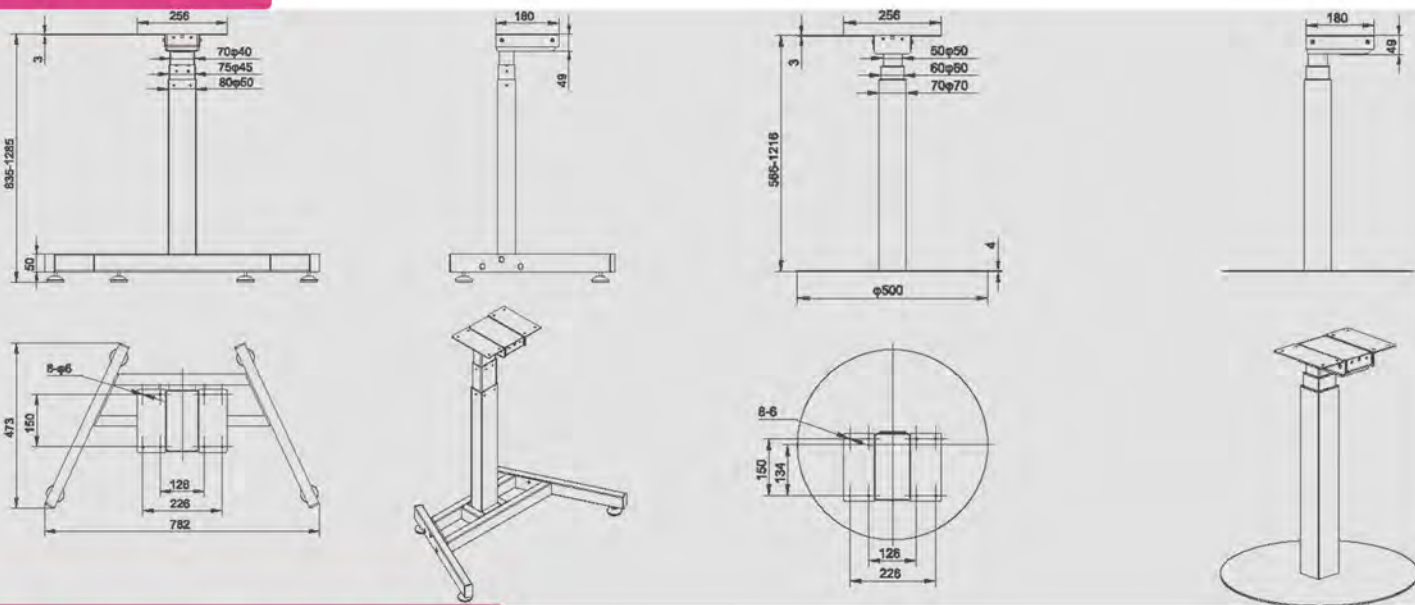

Optional colors 可选颜色



Gray 灰色



Black 黑色

Four motors three segments electric height adjustable desk frame

四电机三节电动升降桌支架



TECHNICAL DATA			
MJC-004			
产品参数			
Specification	四电机三节	Four motors three segments	
Speed	速度	30mm/s	
Max Load	单腿承重	1000N/leg	
Length 1 长	Min	1072mm	(42.20inch)
	Max	1870mm	(73.62inch)
Length 2 长		1479mm	(58.23inch)
Length 3 长		267mm	(10.51inch)
Width 宽	W	575mm	(22.60inch)
	min	604mm	(23.78inch)
Height 高	max	1254mm	(49.37inch)
Foot size	足部尺寸	700*70*20mm	
Tube size	腿管尺寸	80X50mm 70X70mm	
Duty cycle		10% max 2min continuous use	
Input voltage	输入电压	110V or 230V	
Tube material	腿管材质	Steel	
Operating temperature	运行温度	-5°C - +40°C	
IP Grade	IP等级	IP20	
Color 颜色	White	Black	Gray
	白色	黑色	灰色



Optional Two segments and wiring duct

可选两节款及走线槽

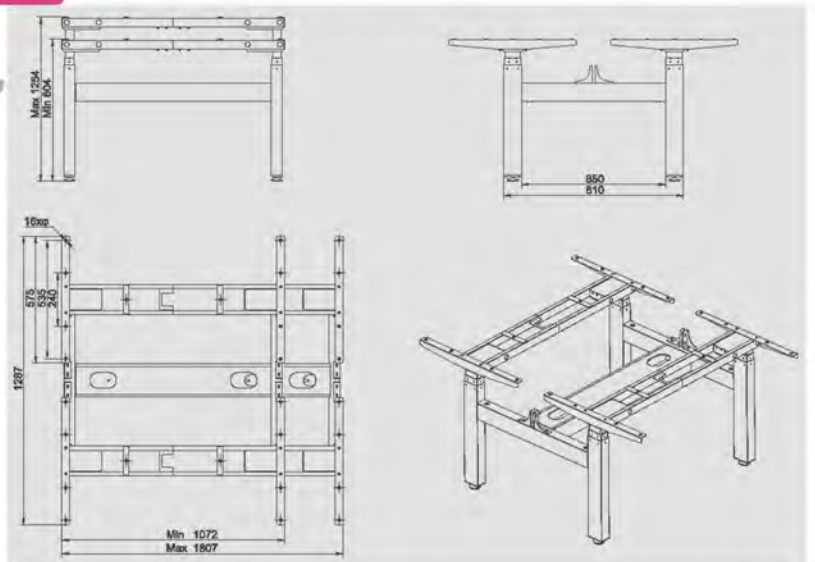

Optional colors 可选颜色



Gray 灰色



Black 黑色

Gas spring height adjustable desk series

气动升降桌系列



MJC-UP110

Tabletop size:650*550*18mm

Table Base Material: Aluminum

Height adjustable range:760-1135mm

Other features:Movable caster, Cup holder&Book holder



Gas spring height adjustable desk series

气动升降桌系列

MJC-IP-2G



Tabletop size:
715*475*25mm
Table Base Material:
Aluminum
Height adjustable range:
750-1050mm
Other feature:
Movable caster



Drawing table

绘图桌

H07



H11



1190*600*760mm

H12



1040*600*800mm

H14



1100*600*750mm

Anti-fatigue mat

抗疲劳立垫



About Megatron anti-fatigue mat

Megatron anti-fatigue mat is made up of PU foam, it's designed to reduce fatigue or uncomfortableness caused by long time standing. Especially suit to the people who need long time standing such as office staffs who're using standing desks, reserchers in laboratory, cooks in kitchen, barbers in barbershop, doctors in hospital etc. After used Megatron anti-fatigue mat, people can find their shank muscle fatigue and heel ache relieved. Some people can even relieve from the pain of varicosity which caused by their career.

Megatron anti-fatigue mat also has electrostatic eliminating function, it can help you to eliminate static generated by your body or static accumulation caused from long time faced the monitor, with which your skin aging will be delayed and your eyes are protected.

关于美嘉创抗疲劳垫

美嘉创抗疲劳垫是以发泡PU作为基材制成，它被设计用来减轻由长期站立导致的不适合疲劳感。尤其适合需要长时间站立不动的人群比如使用升降办公桌的办公室职员，实验室实验的科研人员，厨房的厨师，理发店的理发师，医院的医生等。通过使用美嘉创抗疲劳垫后可以明显缓解小脚部肌肉疲劳度以及脚后跟的酸痛感，有些由于职业关系已经有静脉曲张趋势的人员使用后甚至能缓解病情。美嘉创抗疲劳垫除静电功效，可以消除人体静电以及因长时间面对显示器导致的静电荷聚积，间接达到延缓皮肤衰老，保护视力等功效。



TECHNICAL DATA

Base material	基材	PU foam (PU发泡)
Surface matrial	表面材料	PVC PU (人造革) Textilene(特斯林)
Thickness	厚度	20mm
Size	尺寸	510X810mm;510X990mm
Design	款式	Beveled edge倒边
Clean method	清洗方法	Wipe with wet cloth, don't machine wash. 用湿抹布擦洗，不可机洗。

Size & shape customizable 尺寸和形状可定制

Anti-fatigue mat color samples

抗疲劳立垫颜色样卡



TP01
Crocodile
鳄鱼纹



TP02
Chocolate grid
巧克力方格



TP03
Giraffe
长颈鹿纹

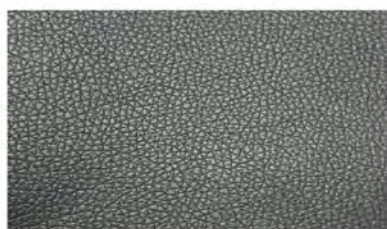

TP04
Rhino Black
黑犀牛



TP05
Rhombus
菱形纹



TP07
Red Mabel
红色大理石

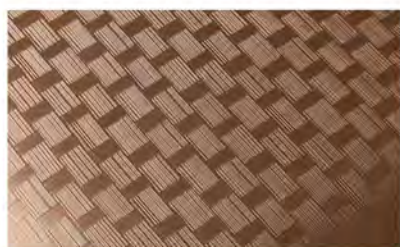

TP08
Brass fiber
铜线



TP10
Pink Gold
粉金色



TP12
Silver river
银色河流



TP17
Metal surface
金属表面



TP19
Cloth surface
布面



TB07
Flower
花

Multi-functional Socket and wireless charger

多功能线盒和无线充电器

XH-300



产品名称: 铝面板桌面插座
Product name: Multifunctional desktop socket

材质: 铝合金+铁板
Material: Aluminum alloy+iron

面板尺寸: 265*130*78 (mm)
The panel size: 265*130*78 (mm)

底盒尺寸: 253*116*73 (建议开孔加大1-2mm)
Bottom box size: 253*116*73 (suggest to open 1-2mm more)

颜色: 拉丝银/拉丝黑
Color: Brushed silver/Brushed black

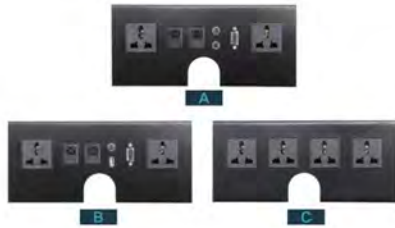

TECHNICAL DATA

Material 材质	Aluminum alloy	铝合金
Surface treatment 表面处理	Brushed	拉丝
Surface Size 表面尺寸	265X130X78mm	
Hole size 开孔尺寸	253X116mm(1-2mm bigger)	

Layout 平面图

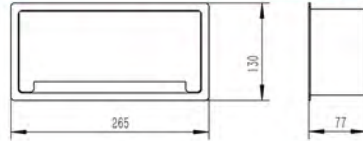

Optional jack 可选插孔



XH-WX-C

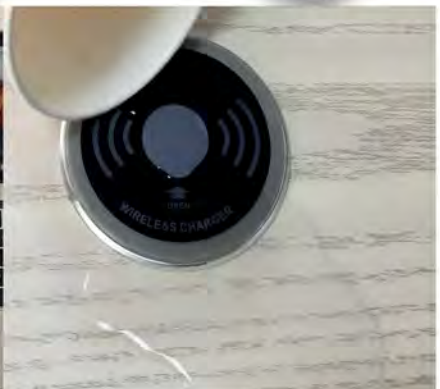
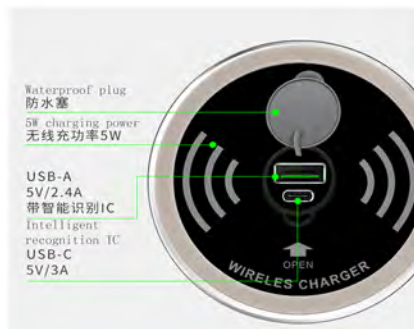

TECHNICAL DATA

Wireless power charge sender 无线充电器发送器		
Surface 面板	Polycarbonate(PC)	聚碳酸酯
Surface Size 表面尺寸	φ66mm	
Hole size 开孔尺寸	φ60mm	
Convert efficiency 转换效率	75%	
Applied standard 适用标准	Qi	
Wireless power charge receiver 无线充电器接收器		
Plug type 插头型号	Universal for Apple/Android/Type C	
Input/Output power	5W/1000mA	
Certificate	CE	RoHS FCC
Net weight	50g	
Size	56X40X10.3mm	

PET acoustic panel series

聚酯纤维吸声板系列

Looking for a quiet space at a bar or office? Megatron PET acoustic panels can help you to create a small quiet world at a noisy environment with their excellent sound absorb ability. You can assemble the panels quickly for the structure is so simple, the most important thing is the material is healthy, no hazardous substance contained, with our products, you can have a quiet, healthy and concise space immediately.

想要在喧嚣的办公室或者酒吧找一个安静的空间吗？美嘉创聚酯纤维吸声板可以助你在嘈杂的环境中建立一小块安静的空间，我们的产品具有优越的吸声性能，安装简单快捷，更重要的是我们的产品不含任何有害物质，使用我们的产品，你可以快速的创建一个安静健康简洁的个人空间。



PET acoustic panels

PET吸声板系列

Desktop partition 桌面屏风

Material: Polyester fiber

材料：聚酯纤维

Recommend size:

推荐尺寸

980*340*15mm

1180*340*15mm

1180*580*15mm

1380*340*15mm

Office acoustic solution 办公室降噪解决方案

Features 产品特色

- Sound absorb, reduce office noises. 吸音，降低办公室噪音。
- Simple structure and parts, easy to install & dismantle. 结构和配件简单，易于安装和拆解。
- Light and easy to move. 简便易于移动。
- More colorful only you can imagine. 色彩更丰富，只要您能想到。

Monitor Mount

显示器支架



Universal joint fits for most of the monitors

Wire duct for wire organizing

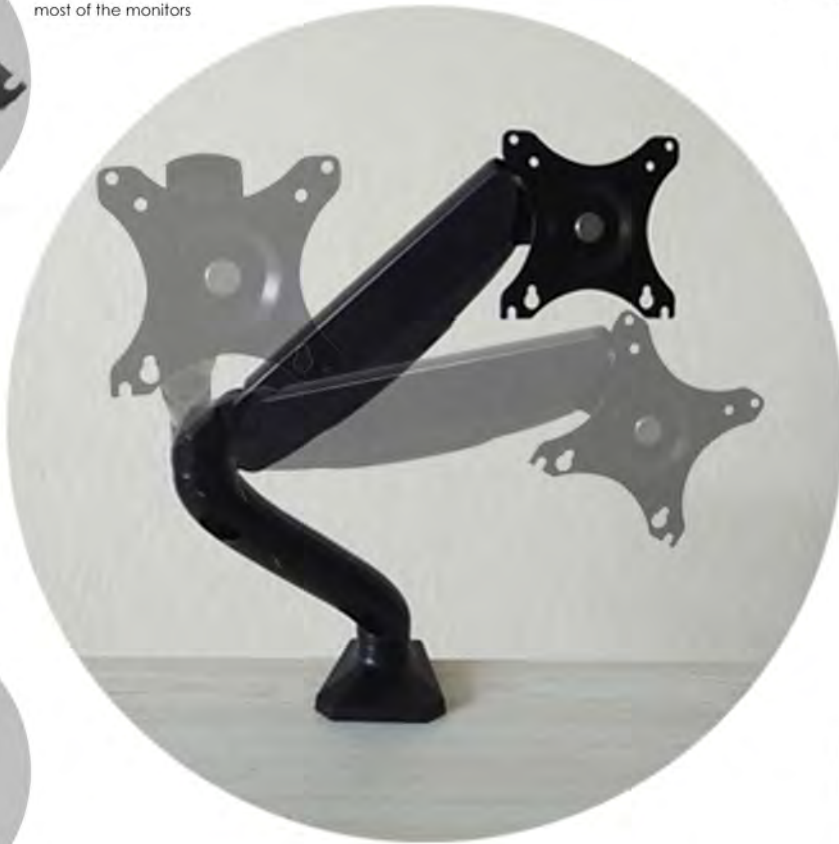

Horizontal 360° rotate
Vertical 90° adjustable

Desktop thickness up to 145mm
adaptable



Support monitor size: 10"-27"

Weight capacity: 2-9kg

VESA Hole Pattern: 100x100MM or 75x75MM



Articulated arm offers 90° tilt and 90° swivel.
The internal counterbalance gas spring creates a free-float effect that allows you to instantly adjust the height of your monitor without tools.

Functional Sofa

Breathing Skin Series



MJC-1BSW



MJC-1BSG



MJC-1BSC

Lint Series



MJC-2BSR



MJC-2BSB



MJC-2BSC

One step to relax



Size: (LXWXH)720X780X970mm



Back length:490mm
Seat width:490mm
Seat high:480mm



Total length:1500mm
seat length:530mm
Feet pad length:480mm

Wire organizer series

走线盒系列

Plastic round wire organizers



Elegant & Durable



Material: Plastic



PW50 Silver White



PW53 Silver White



PW60 Silver White



PW60 Black Waterdrop



PW60 Arc Shape Silver

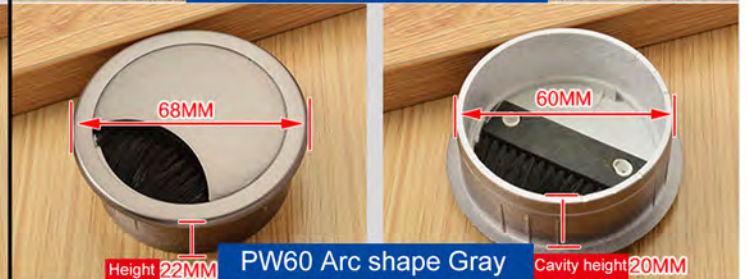

PW60 Arc shape Gray

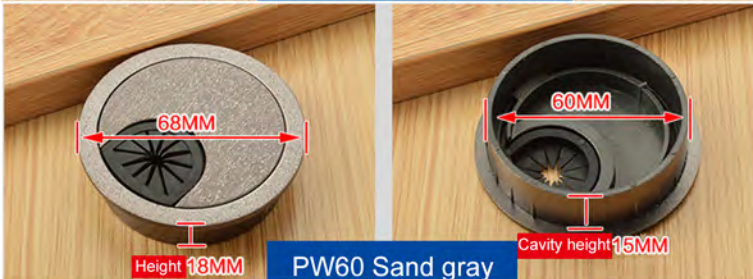

PW60 Sand gray

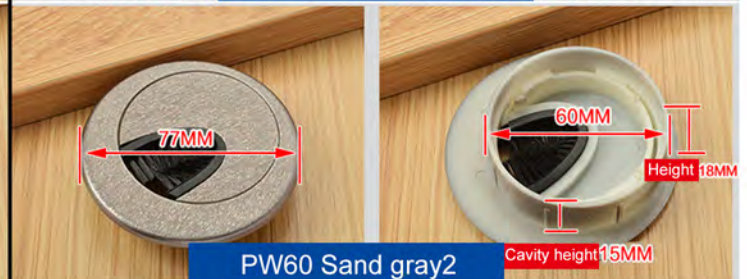

PW60 Sand gray2

Wire organizer series

走线盒系列



Zinc alloy wire organizer



ZW-1 Polished surface



ZW-2 Brushed surface



ZW-3 Antique copper



ZW-4 Shinning gold

Wire organizer series

走线盒系列

Plastic/Aluminum alloy square wire organizers



Modern & concise



PS160 Arc Gray



Top size:160*90mm
Bottom size:150*80mm
Height:25mm

PS 80 Sand silver



Top size:80*80mm
Bottom size:67*67mm
Height:20mm

PS 160 Sand coffee



Top size:160*90mm
Bottom size:150*80mm
Height:25mm

AS 200 Golden



Top size:200*80mm
Bottom size:190*70mm
Height:20mm

Aluminum

AS 280 Antique copper



Top size:280*80mm
Bottom size:270*70mm
Height:20mm

Parts & accessories

配件和附件

Lift columns 升降立柱



TECHNICAL DATA	
MJC-2S Series	
产品参数	
Specification	单电机两节 Single motor two segments
Speed	速度 20mm/s
Max Load	单腿承重 1500N/leg
Height 高	min 650mm (25.59inch)
	max 1150mm (45.28inch)
Tube size	腿管尺寸 80X50mm
Duty cycle	10% max 2min continuous use
Input voltage	输入电压 110V or 230V
Tube material	腿管材质 Steel
Operating temperature	运行温度 +5°C +40°C
IP Grade	IP等级 IP20



TECHNICAL DATA	
MJC-3S Series	
产品参数	
Specification	单电机三节 Single motor three segments
Speed	速度 30mm/s
Max Load	单腿承重 1000N/leg
Height 高	min 560mm (22.05inch)
	max 1210mm (47.64inch)
Foot size	足部尺寸 700*70*20mm
Tube size	腿管尺寸 80X50mm 70X70mm
Duty cycle	10% max 2min continuous use
Input voltage	输入电压 110V or 230V
Tube material	腿管材质 Steel
Operating temperature	运行温度 +5°C +40°C
IP Grade	IP等级 IP20

Handset 手控器



PET flower pendant lamp & Partition 悬挂式PET种花吊灯及隔档



Optional foot shape & crossbar 可选桌脚形状及横杆



Brackets



*White,Black,Silver colors available

Snake shape wiring tubes



Material: ABS

Size:68*35*800mm

*White,Black,Silver colors available

Sofa bed

沙发床



MJC-1ZD

Size:Length:85-190CM

Width:61CM

Height:96CM-65CM



MJC-2ZD

Size:Width:78CM Depth:81.5-192CM Hight:46CM



Desktop board

桌面板

ZM-001



L-ZM-001



ZM-002



ZM-M-001

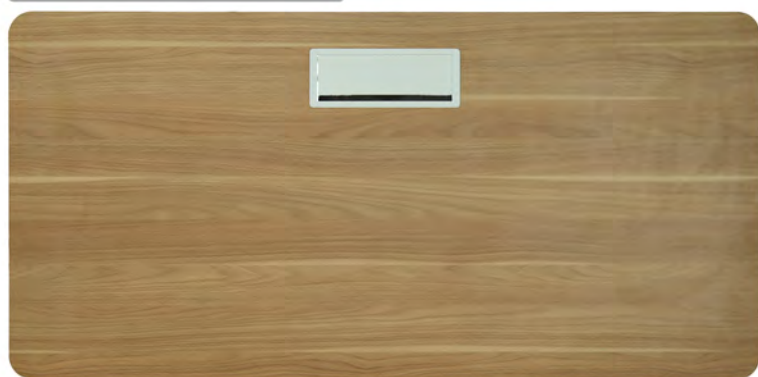

·Desktop customizable
·桌面板可定制

TECHNICAL DATA





Board material桌板材料	Bamboo 竹板	MDF中密度纤维板	
Formaldehyde Emission Standard甲醛排放级别	E1		
Thickness厚度	20mm	25mm	
Size 1	1200X600mm		
Size 2	1524X762mm		
Size 3	1800X1200mm		
Size 4	2000X1200mm		
Shape 形状			
Design 款式	Round corner 圆角	Beveling 倒角	Banding 封边
Color 颜色			

Table & chair legs 桌椅脚系列

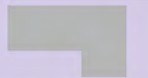

Mass designs, unlimited ideas and addable weight

Best quality of table & chair legs

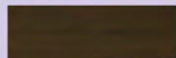
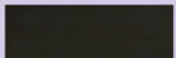

Table legs 桌脚系列



MJC-101



MJC-102



MJC-103



MJC-104



MJC-205



MJC-206



MJC-207



MJC-301



MJC-302



MJC-303



MJC-304

Table legs 桌脚系列



MJC-403



MJC-404



MJC-405



MJC-406



MJC-406S



MJC-T130G



MJC-TBX01



MJC-270



MJC-280

Chair legs 椅脚系列



MJC-C101



MJC-C102



MJC-C103



MJC-C104



MJC-C301



MJC-C302



MJC-C303



MJC-C304



MJC-C801



MJC-C802



MJC-C803



MJC-C804



MJC-C305



MJC-C501



MJC-C502



MJC-C503

Contact us

联系我们

Our website:

www.megatroncz.com

地址：中国江苏省常州市经济开发区
东方东路51号。

Add: No. 51th East Dongfang Rd.,
Economic Development Zone,
Changzhou, Jiansu, China

电话(Tel): +86-519-86221721

传真(Fax): +86-519-89622652

联系人 (Contact) : 卞冬明 Kelvin Bian

移动电话 (MP) : +86-15806125196

E-mail: kelvin@megatroncz.com

Whatsapp & Skype: +86-15806125196

Facebook: biandm04@163.com

Twitter: @megatron_kelvin

国内业务:

联系人: 谢先跃 电话: 15351921915

扫码登录我们的网站

Scan to visit our website



请用微信扫码加为好友

Scan to contact with WeChat

