

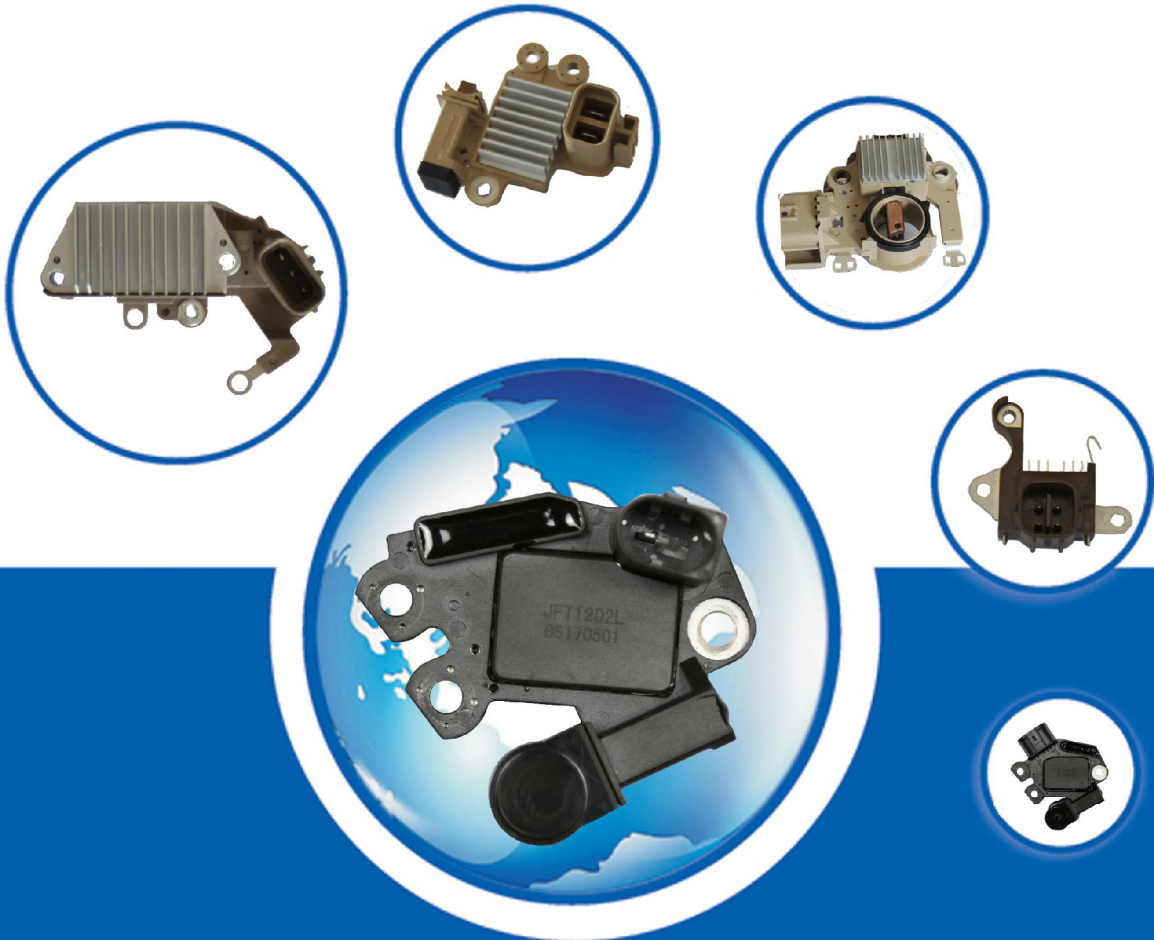

# 徐州骏玛特电子贸易有限公司

XUZHOU JUNMAT ELECTRONIC TRADING CO., LTD



品质精益求精

服务全心全意

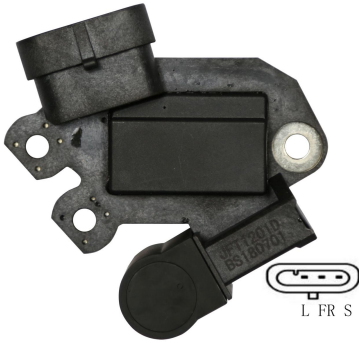

### JFT1201D

★性能参数[Features]

调节电压[Vsetting]: 14.5V  
 出线方式[Terminal dentification]:  
 B+-F-P-E-L-FR-S  
 负载响应控制[LRC] 5Sec

★配套车型 [Auto Type]

别克 GL8 陆尊 3.0

★备注[Remark]

MOBILETRON: VR-V2499

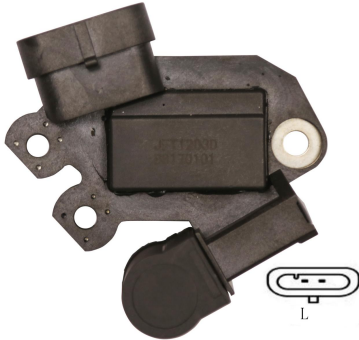

### JFT1203D

★性能参数[Features]

调节电压[Vsetting]: 14.5V  
 出线方式[Terminal dentification]:  
 B+-F-P-E-L  
 负载响应控制[LRC] 5Sec

★配套车型 [Auto Type]

雪佛兰景程 1.8L

★备注[Remark]

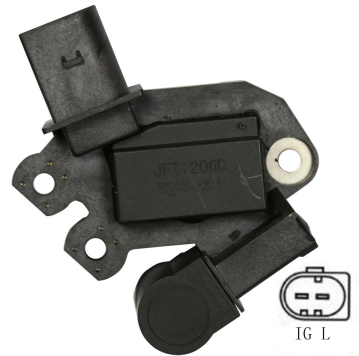

### JFT1206D

★性能参数[Features]

调节电压[Vsetting]: 14.5V  
 出线方式[Terminal dentification]:  
 B+-F-P-E-L-IG  
 负载响应控制[LRC] 5Sec

★配套车型 [Auto Type]

北京华泰

★备注[Remark]



### JFT1208D

★性能参数[Features]

调节电压[Vsetting]: 14.5V  
 出线方式[Terminal dentification]:  
 B+-F-P-E-L-FR  
 负载响应控制[LRC] 5Sec

★配套车型 [Auto Type]

大众系列 迈腾 宝来 POLO  
 速腾 朗逸 帕萨特

★备注[Remark]

YY: 08-006

MOBILETRON: VR-PR2292H

TRANSPO: M521



### JFT1209

★性能参数[Features]

调节电压[Vsetting]: 14.5V  
 出线方式[Terminal dentification]:  
 B+-F-E-D+-IG-L

★配套车型 [Auto Type]

现代途胜 老款索纳塔

★备注[Remark]

YY: 08-036

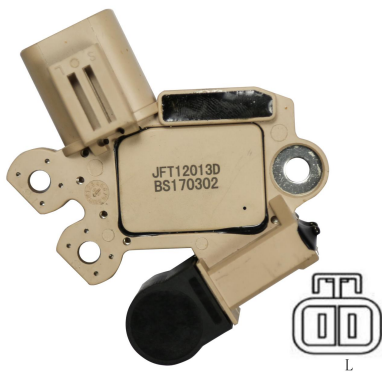

### JFT12013D

★性能参数[Features]

调节电压[Vsetting]: 14.5V  
 出线方式[Terminal dentification]:  
 B+-F-P-E-L  
 负载响应控制[LRC] 5Sec

★配套车型 [Auto Type]

★备注[Remark]

VALEO:20051012 2655001 2655479  
 YY: 08-052  
 MOBILETRON: VR-V5001  
 TRANSP0: M531

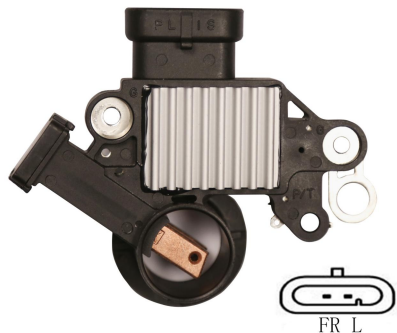

### JFT12015D

★性能参数[Features]

调节电压[Vsetting]: 14.5V  
 出线方式[Terminal dentification]:  
 B+-F-P-E-L-FR  
 负载响应控制[LRC] 5Sec

★配套车型 [Auto Type]

★备注[Remark]

YY: 01-066

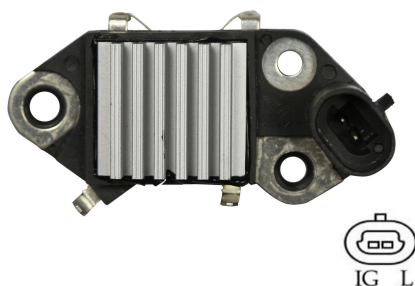

### JFT12016

★性能参数[Features]

调节电压[Vsetting]: 14.5V  
 出线方式[Terminal dentification]:  
 B+-F-D+-E-IG-L

★配套车型 [Auto Type]

★备注[Remark]

YY: 01-037  
 MOBILETRON: VR-D217



### JFT12017D-1

★性能参数[Features]

调节电压[Vsetting]: 14.5V  
 出线方式[Terminal dentification]:  
 B+-F-P-E-L-FR  
 负载响应控制[LRC] 5Sec

★配套车型 [Auto Type]

瑞纳 悦动

★备注[Remark]

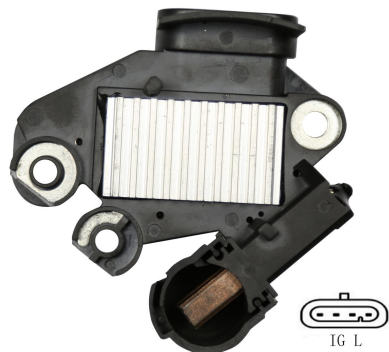

### JFT12018

★性能参数[Features]

调节电压[Vsetting]: 14.5V  
 出线方式[Terminal dentification]:  
 B+-F-D+-E-IG-L

★配套车型 [Auto Type]

别克凯越 1.6

★备注[Remark]



## JFT12025D

★性能参数[Features]

调节电压[Vsetting]: 14.5V  
 出线方式[Terminal dentification]:  
 B+-F-P-E-L-FR  
 负载响应控制[LRC] 5Sec

★配套车型 [Auto Type]  
 雷诺

★备注[Remark]  
 VALEO:593361 2541952  
 YY: 08-012  
 MOBILETRON: VR-PR1620  
 TRANSP0: M516

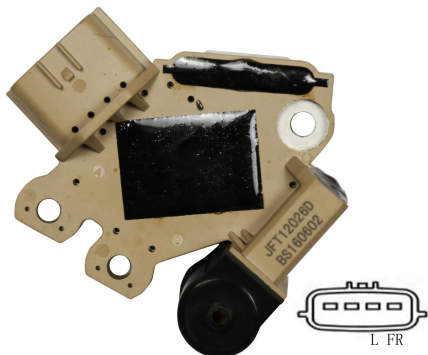

## JFT12026D

★性能参数[Features]

调节电压[Vsetting]: 14.5V  
 出线方式[Terminal dentification]:  
 B+-F-P-E-L-FR  
 负载响应控制[LRC] 5Sec

★配套车型 [Auto Type]

★备注[Remark]  
 VALEO:20071017 20080622  
 YY:08-063  
 MOBILETRON:VR-PR5011  
 TRANSP0:M563



## JFT12027D

★性能参数[Features]

调节电压[Vsetting]: 14.5V  
 出线方式[Terminal dentification]:  
 B+-F-P-E-L-FR  
 负载响应控制[LRC] 5Sec

★配套车型 [Auto Type]

★备注[Remark]  
 VALEO:20030410 20031203 20050725  
 YY:08-064  
 TRANSP0:M536



## JFT12035D

★性能参数[Features]

调节电压[Vsetting]: 14.5V  
 出线方式[Terminal dentification]:  
 B+-F-P-E-L-FR  
 负载响应控制[LRC] 5Sec

★配套车型 [Auto Type]  
 雷诺

★备注[Remark]  
 VALEO:2542299  
 YY: 08-008  
 MOBILETRON:VR-PR2299H

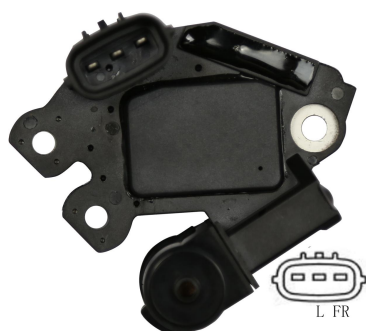

## JFT12036D

★性能参数[Features]

调节电压[Vsetting]: 14.5V  
 出线方式[Terminal dentification]:  
 B+-F-P-E-L-FR  
 负载响应控制[LRC] 5Sec

★配套车型 [Auto Type]  
 智跑

★备注[Remark]  
 VALEO:20080710  
 YY: 08-085  
 TRANSP0:M544

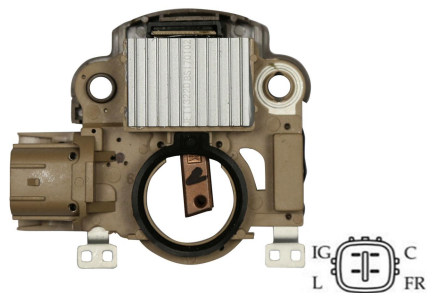

## JFT1322D

### ★性能参数[Features]

调节电压[Vsetting]: 14.5V  
 出线方式[Terminal identification]: B+-P-F-E-IG-L-C-FR  
 负载响应控制[LRC] 5Sec

### ★配套车型[Auto Type]

本田思域 本田 CRV

### ★备注[Remark]

YY: 06-108  
 MOBILETRON: VR-H2009-94  
 TRANSP0: IM851  
 JDWP: JRG1039

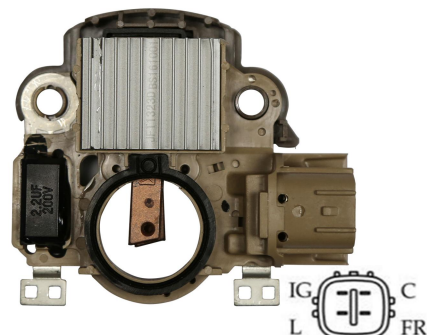

## JFT1323D

### ★性能参数[Features]

调节电压[Vsetting]: 14.5V  
 出线方式[Terminal identification]: B+-P-F-E-IG-L-C-FR  
 负载响应控制[LRC] 5Sec

### ★配套车型[Auto Type]

本田思域 本田 CRV

### ★备注[Remark]

YY: 06-109

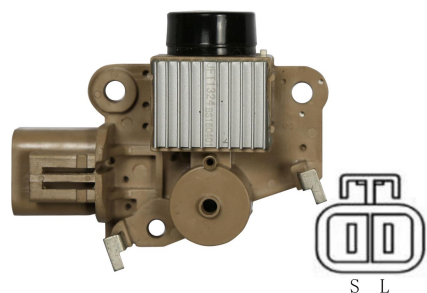

## JFT1324

### ★性能参数[Features]

调节电压[Vsetting]: 14.5V  
 出线方式[Terminal Identification]: B+-D+-F-E-L-S

### ★配套车型[Auto Type]

### ★备注[Remark]

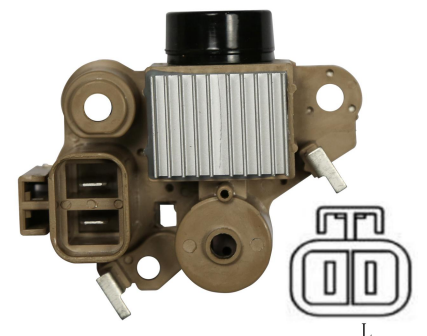

## JFT1326

### ★性能参数[Features]

调节电压[Vsetting]: 14.5V  
 出线方式[Terminal Identification]: B+-D+-F-E-L

### ★配套车型[Auto Type]

### ★备注[Remark]

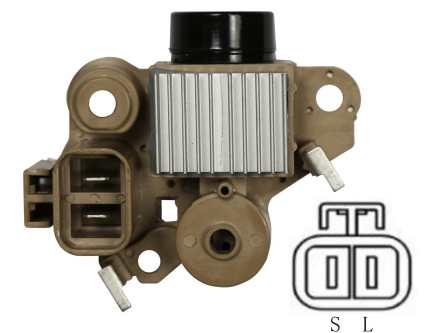

## JFT1326-1

### ★性能参数[Features]

调节电压[Vsetting]: 14.5V  
 出线方式[Terminal Identification]: B+-D+-F-E-L-S

### ★配套车型[Auto Type]

### ★备注[Remark]

YY: 06-066  
 MOBILETRON: VR-MD06  
 TRANSP0: IY028

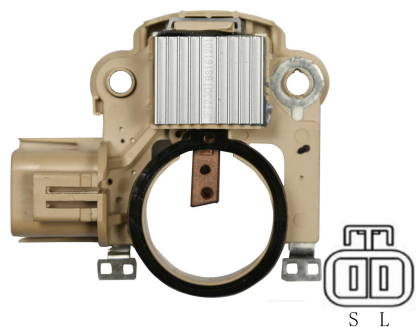

### JFT2301

★性能参数[Features]

调节电压[Vsetting]: 28.5V  
 出线方式[Terminal Identification]:  
 B+-D+-F-E-L-S

★配套车型[Auto Type]

★备注[Remark]

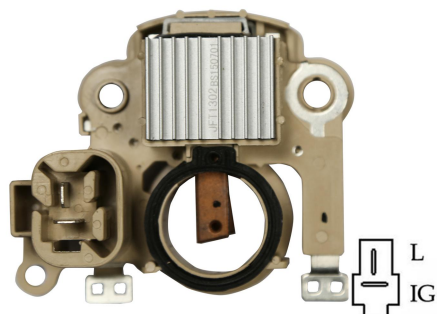

### JFT2302

★性能参数[Features]

调节电压[Vsetting]: 28.5V  
 出线方式[Terminal Identification]:  
 B+-D+-F-E-L-IG

★配套车型[Auto Type]

★备注[Remark]

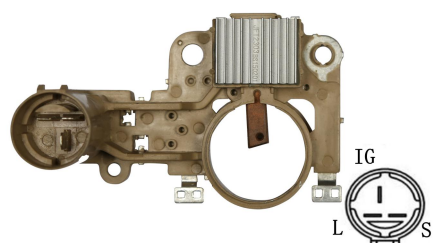

### JFT2303

★性能参数[Features]

调节电压[Vsetting]: 28.5V  
 出线方式[Terminal Identification]:  
 B+-D+-F-E-S-IG-L

★配套车型[Auto Type]

★备注[Remark]

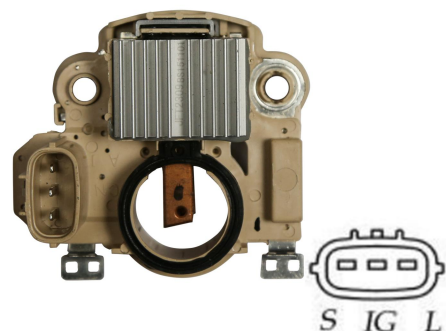

### JFT2309

★性能参数[Features]

调节电压[Vsetting]: 28.5V  
 出线方式[Terminal Identification]:  
 B+-P-F-E-S-IG-L

★配套车型[Auto Type]

★备注[Remark]

YY: 06-115  
 MOBILETRON: VR-H2009-135B

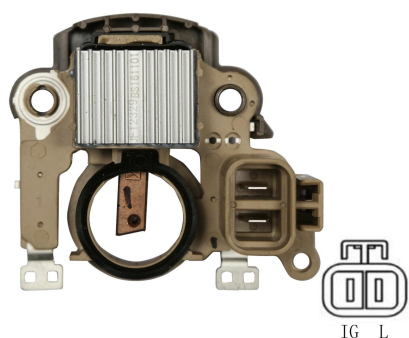

### JFT2329

★性能参数[Features]

调节电压[Vsetting]: 28.5V  
 出线方式[Terminal Identification]:  
 B+-D+-F-E-L-IG

★配套车型[Auto Type]

★备注[Remark]

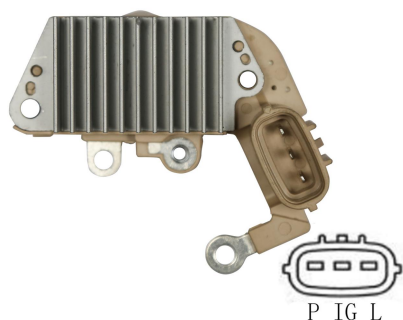

### JFT1407

★性能参数[Features]

调节电压[Vsetting]: 14.5V  
 安装距[Mounting Length]: 57.5mm  
 出线方式[Terminal dentification]:  
 B+-P-F-E-P-IG-L

★配套车型[Auto Type]

★备注[Remark]  
 YY: 03-025  
 MOBILETRON:VR-2005-60  
 TRANSP0:IN450

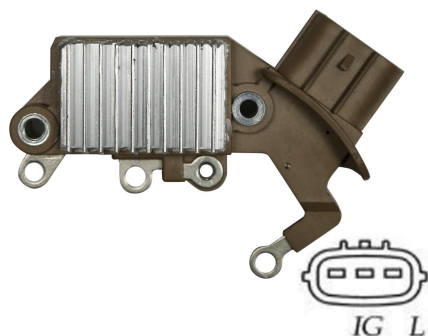

### JFT1408

★性能参数[Features]

调节电压[Vsetting]: 14.5V  
 安装距[Mounting Length]: 63.5mm  
 出线方式[Terminal dentification]:  
 B+-D+-F-E-IG-L

★配套车型[Auto Type]

长安之星  
 奇瑞  
 ★备注[Remark]

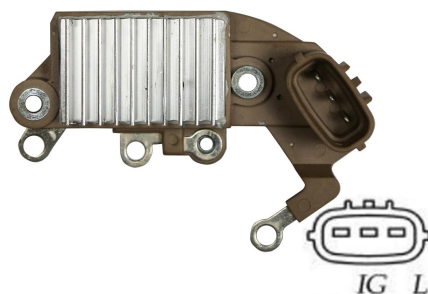

### JFT1409

★性能参数[Features]

调节电压[Vsetting]: 14.5V  
 安装距[Mounting Length]: 63.5mm  
 出线方式[Terminal dentification]:  
 B+-D+-F-E-IG-L

★配套车型[Auto Type]

长安之星  
 奇瑞  
 ★备注[Remark]

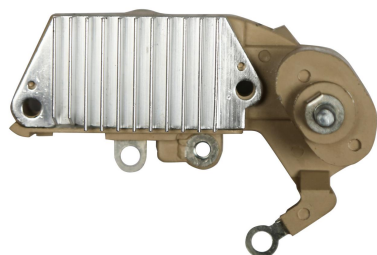

### JFT1414

★性能参数[Features]

调节电压[Vsetting]: 14.5V  
 安装距[Mounting Length]: 63.5mm  
 出线方式[Terminal dentification]:  
 B+-P-F-E-L

★配套车型 [Auto Type]

奇瑞旗云  
 华川森雅  
 ★备注[Remark]



### JFT1416

★性能参数[Features]

调节电压[Vsetting]: 14.5V  
 安装距[Mounting Length]: 57.5mm  
 出线方式[Terminal dentification]:  
 B+-P-F-E-L-IG-L

★配套车型 [Auto Type]

长安之星  
 松花江中意  
 ★备注[Remark]

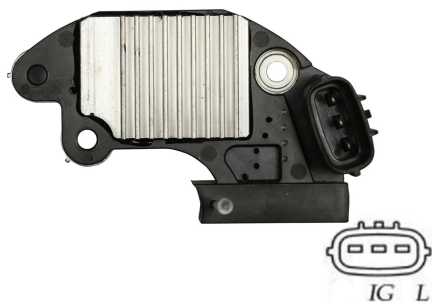

### JFT1502-1

★性能参数 [Features]

调节电压 [Vsetting]: 14.5V  
 出线方式 [Terminal identification]:  
 B+-D+-F-E-IG-L

★配套车型 [Auto Type]

★备注 [Remark]



### JFT1502-2

★性能参数 [Features]

调节电压 [Vsetting]: 14.5V  
 出线方式 [Terminal identification]:  
 B+-P-F-E-IG-L

★配套车型 [Auto Type]

丰田 8A

★备注 [Remark]

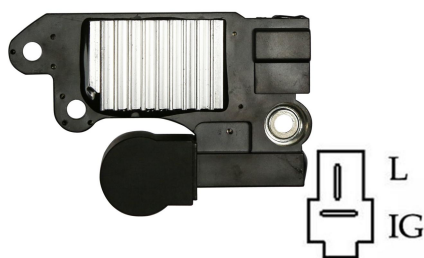

### JFT1503

★性能参数 [Features]

调节电压 [Vsetting]: 14.5V  
 出线方式 [Terminal identification]:  
 B+-D+-F-E-IG-L

★配套车型 [Auto Type]

奇瑞 272 发动机

★备注 [Remark]

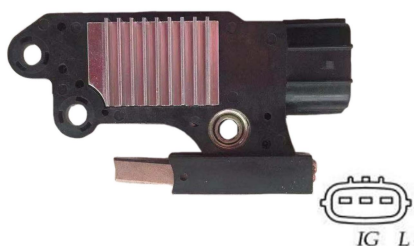

### JFT1504

★性能参数 [Features]

调节电压 [Vsetting]: 14.5V  
 出线方式 [Terminal identification]:  
 B+-D+-F-E-IG-L

★配套车型 [Auto Type]

奇瑞 QQ

★备注 [Remark]

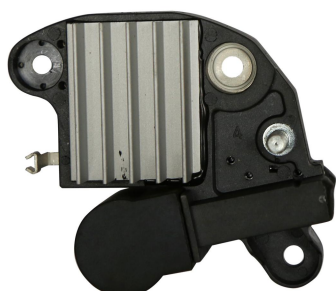

### JFT1505

★性能参数 [Features]

调节电压 [Vsetting]: 14.5V  
 出线方式 [Terminal identification]:  
 B+-D+-F-E-L

★配套车型 [Auto Type]

奇瑞旗云

奇瑞风云

比亚迪 F0

★备注 [Remark]





### JFT2603B-1

★性能参数[Features]

调节电压[Vsetting]: 28.2V

出线方式[Terminal Identification]:

B+-D+-F-E-P

★配套车型[Auto Type]

★备注[Remark]



### JFT2607

★性能参数[Features]

调节电压[Vsetting]: 28.2V

出线方式[Terminal Identification]:

B+-D+-F-E

★配套车型[Auto Type]

拉煤王

★备注[Remark]



### JFT2608

★性能参数[Features]

调节电压[Vsetting]: 28.5V

出线方式[Terminal Identification]:

B+-D+-F-E

★配套车型[Auto Type]

佩特来

★备注[Remark]

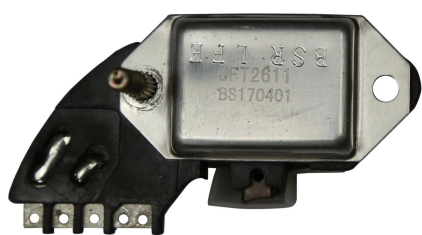

### JFT2611

★性能参数[Features]

调节电压[Vsetting]: 28.5V

出线方式[Terminal Identification]:

B+-D+-F-E-S-IG-L

★配套车型[Auto Type]

小松

★备注[Remark]

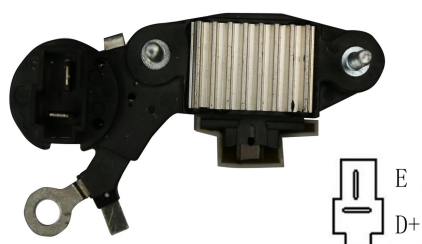

### JFT2615

★性能参数[Features]

调节电压[Vsetting]: 28.5V

出线方式[Terminal Identification]:

B+-D+-F-E-D+-E

★配套车型[Auto Type]

五十铃

★备注[Remark]



### JFT1101L

★性能参数[Features]

调节电压[Vsetting]: 14.2V  
 出线方式[Terminal dentification]:  
 B+-P-F-E-LIN  
 功能类型[type of function]: LIN1.3

★配套车型 [Auto Type]  
 福特 沃尔沃 S60

★备注[Remark]  
 YY: S04-118  
 MOBILETRON: VR-B056  
 TRANSP0: IB6056

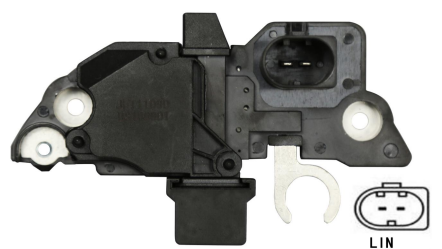

### JFT1112L

★性能参数[Features]

调节电压[Vsetting]: 14.2V  
 出线方式[Terminal dentification]:  
 B+-P-F-E-LIN  
 功能类型[type of function]: LIN1.3:

★配套车型 [Auto Type]  
 奥迪 A4

★备注[Remark]  
 YY: S04-140

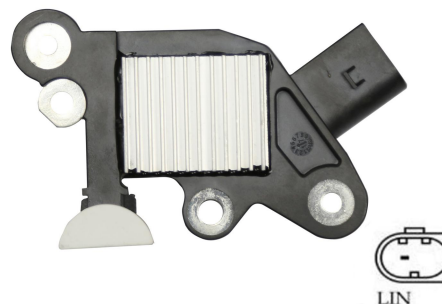

### JFT1113L

★性能参数[Features]

调节电压[Vsetting]: 14.2V  
 出线方式[Terminal dentification]:  
 B+-P-F-E-LIN  
 功能类型[type of function]: LIN1.3

★配套车型 [Auto Type]  
 奔腾 X80

★备注[Remark]  
 OE:2622221



### JFT1114L

★性能参数[Features]

调节电压[Vsetting]: 14.2V  
 出线方式[Terminal dentification]:  
 B+-P-F-E-LIN  
 功能类型[type of function]: LIN1.3

★配套车型 [Auto Type]  
 沃尔沃 S80 XC60 XC90

★备注[Remark]  
 YY: S04-144



### JFT1201L

★性能参数[Features]

调节电压[Vsetting]: 13.8V  
 出线方式[Terminal dentification]:  
 B+-P-F-E-LIN  
 功能类型[type of function]: LIN1.3

★配套车型 [Auto Type]  
 福克斯 福睿斯

★备注[Remark]  
 YY: S08-073  
 TRANSP0:M576



### JFT1202L

★性能参数[Features]

调节电压[Vsetting]: 14.2V  
 出线方式[Terminal dentification]:  
 B+-P-F-E-LIN  
 功能类型[type of function]: LIN1.3

★配套车型 [Auto Type]

奥迪 A6 C6 款

★备注[Remark]

YY: S13805410  
 OE:2543587

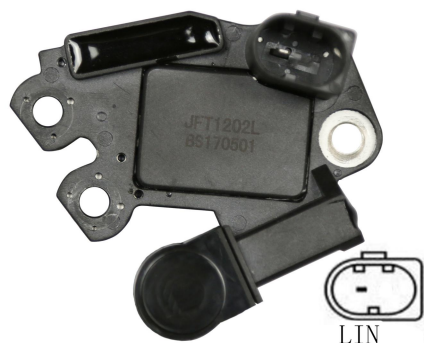

### JFT1202L-1

★性能参数[Features]

调节电压[Vsetting]: 14.2V  
 出线方式[Terminal dentification]:  
 B+-P-F-E-LIN  
 功能类型[type of function]: LIN1.3

★配套车型 [Auto Type]

奥迪 A6 C7 款

★备注[Remark]

YY: 138053G0  
 OE:2613724

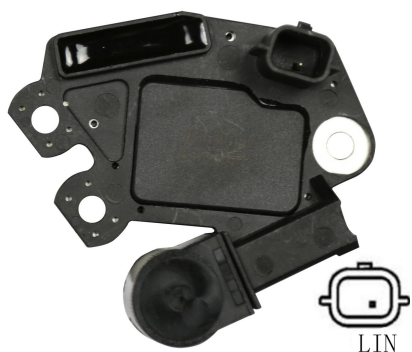

### JFT1203L

★性能参数[Features]

调节电压[Vsetting]: 14.2V  
 出线方式[Terminal dentification]:  
 B+-P-F-E-LIN  
 功能类型[type of function]: LIN2.1

★配套车型 [Auto Type]

奇骏

★备注[Remark]

YY:1380BK00  
 OE:2618689

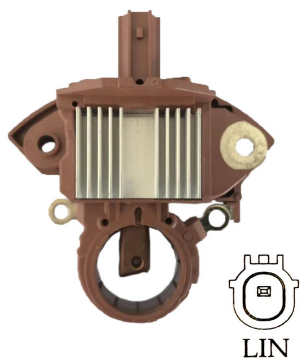

### JFT1368L

★性能参数[Features]

调节电压[Vsetting]: 14.2V  
 出线方式[Terminal dentification]:  
 B+-P-F-E-LIN  
 功能类型[type of function]: LIN2.1

★配套车型 [Auto Type]

13-16 款雅阁 2.4

★备注[Remark]

YY: S13621400

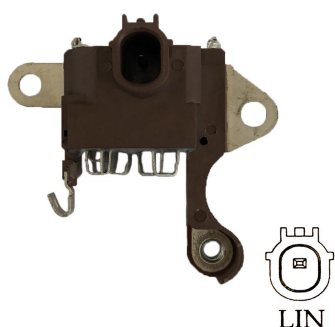

### JFT1449L

★性能参数[Features]

调节电压[Vsetting]: 14.5V  
 出线方式[Terminal dentification]:  
 B+-P-F-E-LIN  
 功能类型[type of function]: LIN2.1:

★配套车型 [Auto Type]

思域 1.5T

★备注[Remark]

YY: S13360100



徐州骏玛特电子贸易有限公司  
XUZHOU JUNMAT ELECTRONIC TRADING CO., LTD

Jojo Wang

☎ 13905202971 WeChat No.

**XUZHOU JUNMAT ELECTRONIC TRADING CO., LTD**

Official website: [jmtdzgroup.com](http://jmtdzgroup.com)

Alibaba website: <https://jmtgroup.en.alibaba.com>

Mailbox: [jmtgroup@sina.com](mailto:jmtgroup@sina.com)

Address: No. 6 Qianjin Road, Suining Economic Development Zone