

佛山市兴蒂丰五金有限公司 13728511235



佛山市兴蒂丰五金制品有限公司
XING DI FENG Hardware Co.,Ltd.

PROFESSIONAL CUBICLES SYSTEM

  佛山市兴蒂丰五金制品有限公司
XING DI FENG Hardware Co.,Ltd.

厂址：广东省佛山市南海区罗村镇联和工业区西区十路1号
Add: No.1,Xiqu 10Rd, Lianhe Industrial Area,luocun,Nanhai,
Foshan City,Guangdong,China

Tel: +86-757-81801101 +86-757-81260015

Fax: +86-757-81801102

Homepage: www.xingdifeng.com

E-mail: info@xingdifeng.com xingdifeng@yeah.net

   : +86-13553327028

● 印刷颜色与实物可能有所偏差，一切请以实物为准。

Company Profile 企业简介

Foshan Xingdifeng Hardware Co., Ltd was founded in 2006. Located in Nanhai district, Foshan city. We are one of leading professional manufacturers on toilet cubicle partition, including all hardwares (leg, hinge, corner bracket, lock set, coat hook, door knob and so on), aluminum profile and HPL(phenolic board). Due to the reasonable and competitive price, high quality, our products are deeply welcomed by customers, and all of our products are sold to Europe, Russia, Middle East, Southeast of Asia.

We take "customer-centric, service-oriented" as our belief, and we sincerely hope that we can have an opportunity to cooperate with your esteemed company in the future.

佛山市兴蒂丰五金制品有限公司于2006年在佛山市南海区成立，主要从事卫生间间隔配件，包括支脚，合页，角码，锁，衣勾，拉手等五金，同时代理销售间隔铝材，抗倍特板一整套产品。企业自创办以来，凭借着合理的产品价格，优质的产品质量，深受广大客商的青睐，产品远销欧洲，俄罗斯，中东，东南亚。

我们秉承顾客至上的原则，真诚希望日后能有机会和贵公司合作。



超越自我
—— 共创辉煌
Unceasing Superego, Work Together in Glory.

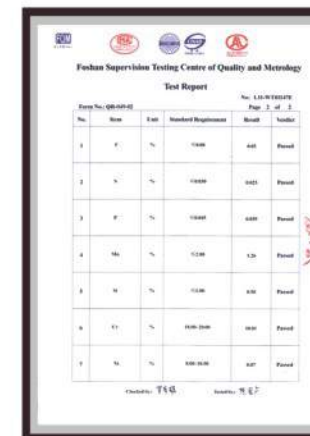
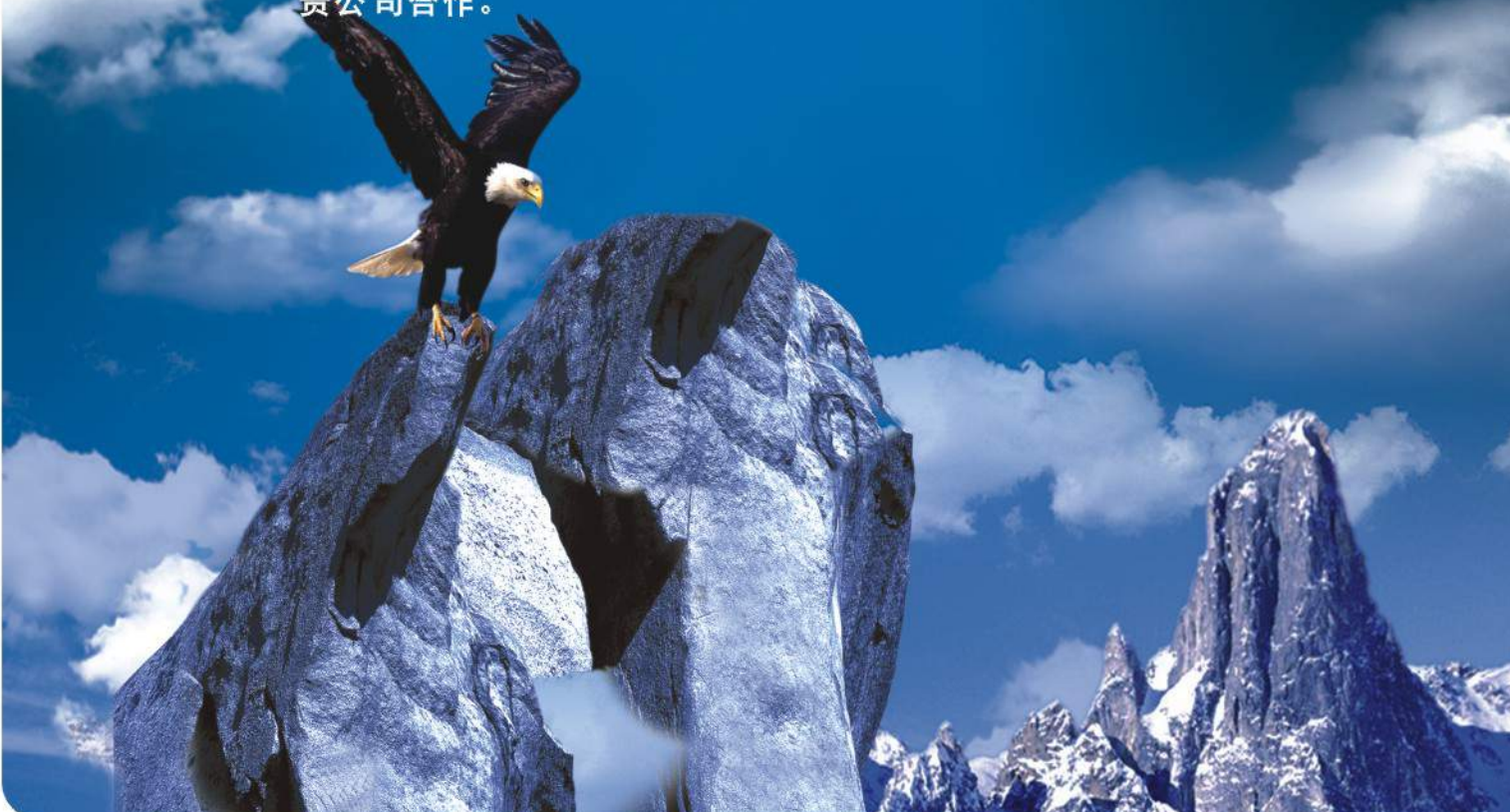

Enterprise Certificate 企业证书



Contents

目录

| | | |
|----------|---|-------|
| A | 卫生间隔断系统 Toilet Partition System | 01-76 |
| | 支架系列 Support Leg Series | 45-50 |
| | 合页系列 Hinge Series | 51-56 |
| | 角码系列 Corner Bracket Series | 57-59 |
| | 锁系列 Lock Set Series | 60-64 |
| | 吊码系列 Hanging Bracket Series | 65-66 |
| | 衣钩系列 Coat Hook Series | 66-68 |
| | 法兰系列 Flange Series | 69 |
| | 连接件系列 Link Series | 70 |
| | 拉手系列 Door Knob Series | 71-73 |
| | 厕纸架系列 Paper Holder Series | 74 |
| | 抗倍特板系列 HPL Board Series | 75-76 |
| B | 内墙系统 Wall Cladding | 77-82 |
| C | 储物柜系统 Lockers System | 83-90 |
| D | 铝材系统 Aluminum System | 91-96 |



先，而后时机在握
Remaining leading,
then grasping opportunities



A

卫生间隔断系统
Toilet Partition System

Cubicle Partition Projects Of
Toilet, Fitting Room, Dressing Room
卫生间、试衣间、更衣室隔断方案

▼ Prototype(效果图)

▼ Horizontal view(平视图)

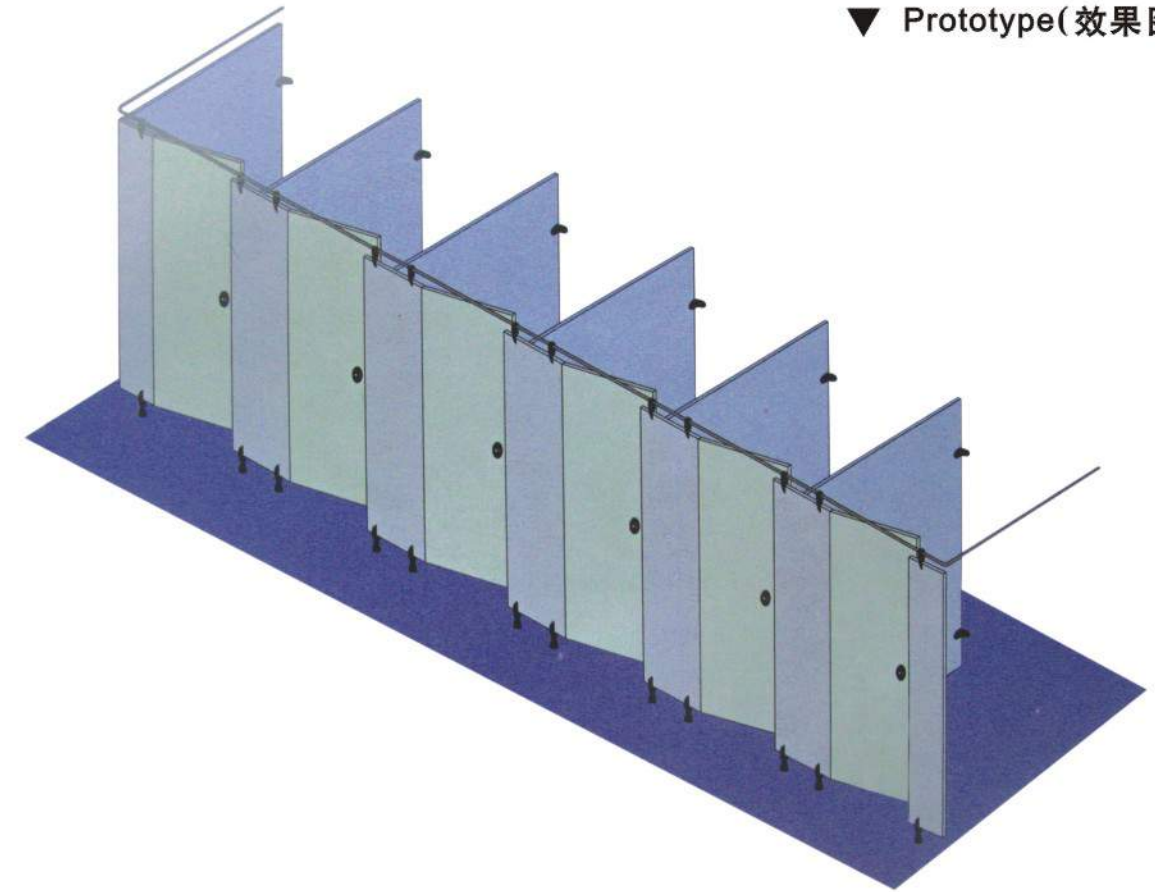
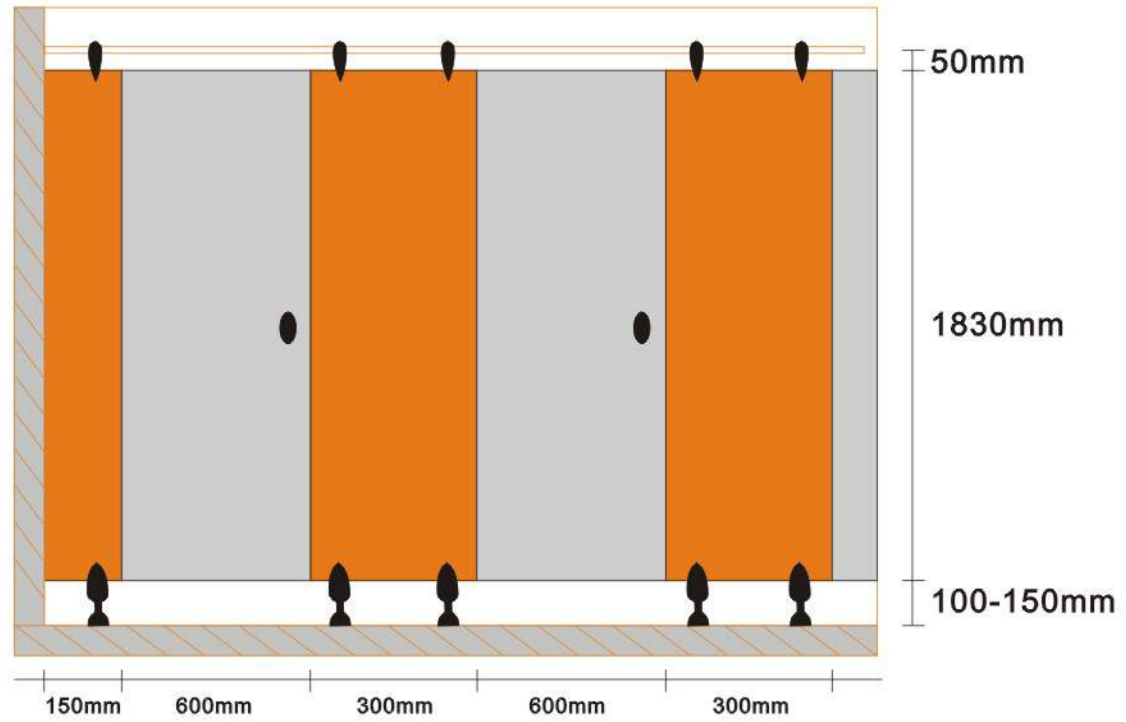

▼ Vertical view(俯视图)

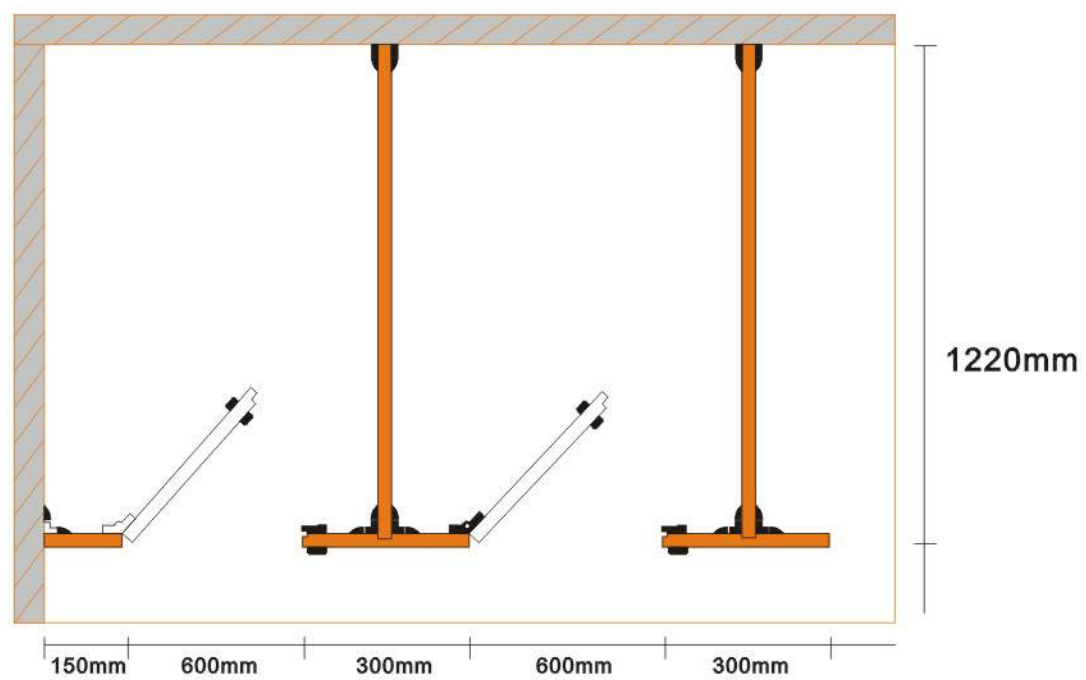

Graphical representation 图形表示

Components in detail
隔断组成图解

- A Divisional panel 中隔板 (P板)
- B Corner fastener 固定角码3个
- C Adjustable leg 支撑脚
- D Door 门 (D板)
- E Aluminum bar 压杆
- F Wall 墙
- G Front board 前挡板 (T板)
- H Hinge 合页
- I Coat hook 衣钩
- J Lock 指示锁
- K Knob 拉手
- L Floor 地面

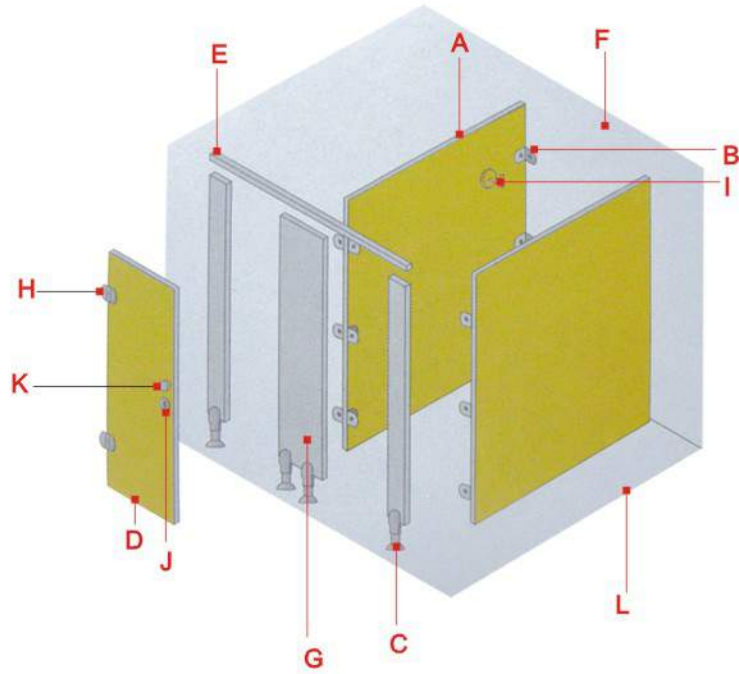

▼ 开门方向与合页左右区分

How to choose the hinge for different directions of door opening

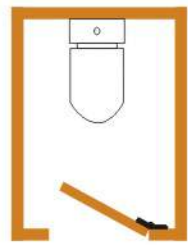

右内开
使用合页左 (L)
Open from Inside:
use Left(L)

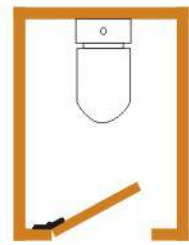

左内开
使用合页右 (R)
Open from Inside:
use Right(R)

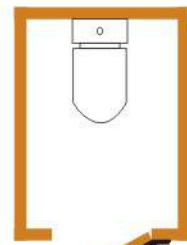

右外开
使用合页右 (R)
Open from Outside:
use Right(R)

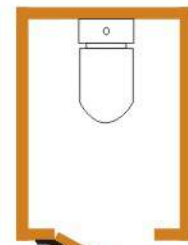

左外开
使用合页左 (L)
Open from Outside:
use Left(L)

Installation steps 安装步骤

A

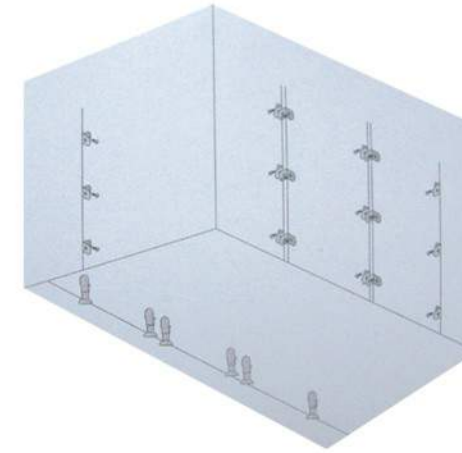

- 1、固定支撑脚:
校好预留门扇与门缝的水平尺寸定位, 再固定支撑脚座上钻孔, 上胶塞上螺丝, 将支撑脚全部固定在相应位置。
- 2、墙体固定角码:
在墙体上制出角码的中心线(一般在两侧位中心位置)定好三点后用电钻钻孔、预埋胶塞再将角码固定在墙上。
- 3、固定T板(前挡板)和P板(中隔板):
根据支撑脚与角码的对应位置, 在T板上划出相应与P板的连接位置装上角码, 再将T板和P板连接成“⊥”字型。
- 4、初步成型卫生间:
将T板和P板连接成的“⊥”字型骨架在原先装好的支撑脚和角码的相应位置上螺丝, 卫生间初具模型。

B

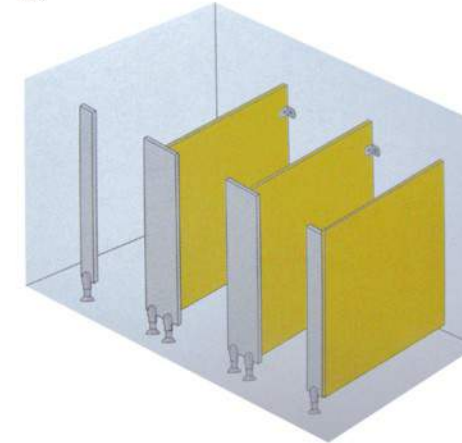

- 5、上横拉杆:
在T板上扣上拉杆, 调好每个门缝预留尺寸, 用螺丝逐个固定。
- 6、上门扇:
先将合页的顶座(不带盖)上在门扇上, 靠上门扇, 留好双边门缝再将合页支座(合页下部分)靠在相应位置上好螺丝, 调整好合页芯归位角度使门扇关闭自如。
- 7、指示锁、拉手:
依不同锁种的孔距在门扇或T板上定位划线、钻孔, 调好有、无人指示上好螺丝。
- 8、装上衣帽钩, 盖上所示螺丝盖、合页盖, 再做一次全面检查; 卫生间安装完毕。

C

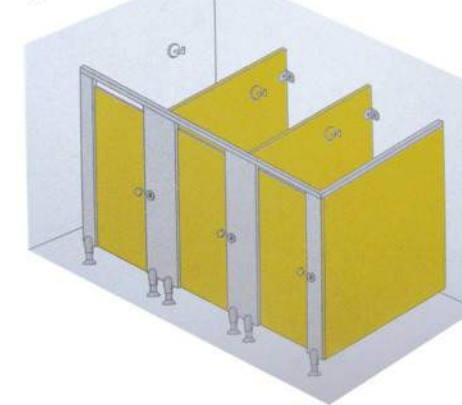

- 1、Fix adjustable leg
Adjust the horizontal size between the door leaf and door frame, then bore holes in the panel, fix the adjustable leg in the appropriate location with screws.
- 2、Fix corner fastener
Draw a center line on the wall (generally in the center of two toilet seats) then use a drill to bore holes, put plastic plug into the holes, finally fix the corner fasteners on the wall.
- 3、Fix front board and middle board
According to the corresponding position of support leg and corner fastener, install the corner fasteners on the connect position of front board and middle board, then connect the front board and middle board as T shape
- 4、Initial toilet partition
Fix the T shape frame on the corresponding position of support leg and corner fastener with screws, the initial toilet partition is formed.
- 5、Fix the bar
Fix the bar on the front board, adjust each door on proper size, then fix with screws one by one.
- 6、Install door
First, fix the hinge(no cover) on the door, keep a suitable door gap, then fix the hinge(supporting part of the hinge) with screws, adjust the hinge to let the door open and close freely.
- 7、Indicator lock, knob
Line and drill on the door or T panel according to the hole distance of different locks, adjust and install it with screws if that is ok.
- 8、Fix coat hook, cover the screw cover and hinge cover, check it again if all are successful, then installation is finished.

XDF-001
Nylon series
尼龙系列



每套标准包装:
STANDARD PACKING LIST
Model:XDF-001

- 1、可调脚座: 2只
Adjustable support leg: 2pcs
- 2、合页: 2个
Hinge: 2pcs
- 3、角码: 12只
Corner fastener: 12pcs
- 4、门锁: 1把
Door lock: 1pcs
- 5、衣帽钩: 1只
Clothes hook: 1pcs
- 6、拉手: 1对
Door knob: 1pair
- 7、厕纸架: 可选
Paper holder: if necessary



N-001

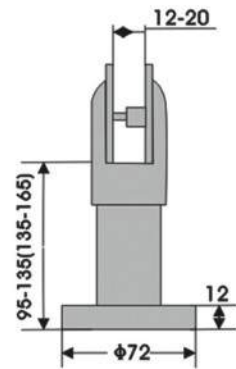

N-002

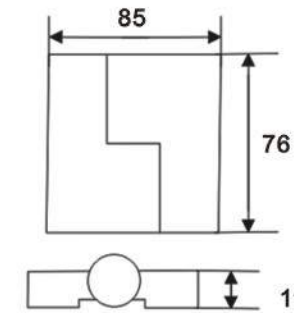

N-003

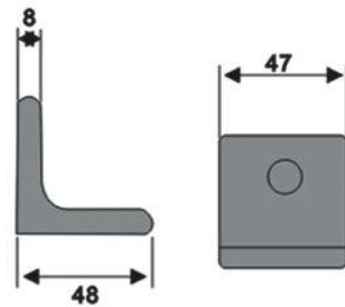

N-004

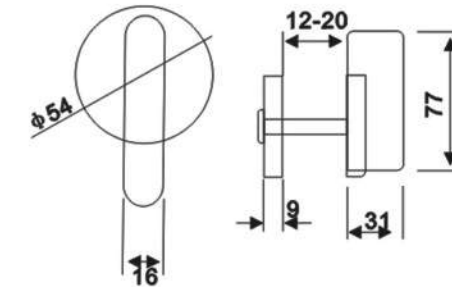

N-005

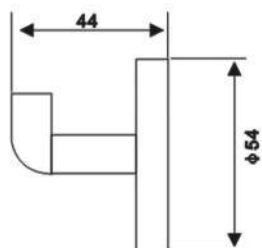

N-006

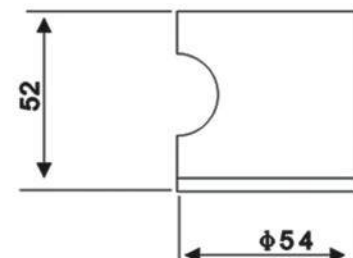

N-007

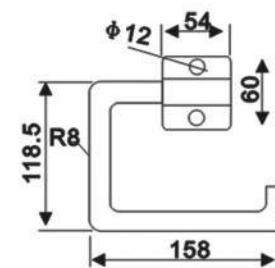

XDF-017
Nylon series
尼龙系列

PICTURE OF
PRODUCTS



每套标准包装:
STANDARD PACKING LIST
Model:XDF-017

- 1、可调脚座: 2只
Adjustable support leg: 2pcs
- 2、合页: 2个
Hinge: 2pcs
- 3、角码: 12只
Corner fastener: 12pcs
- 4、门锁: 1把
Door lock: 1pcs
- 5、衣帽钩: 1只
Clothes hook: 1pcs
- 6、拉手: 1对
Door knob: 1pair
- 7、厕纸架: 可选
Paper holder: if necessary



N-008

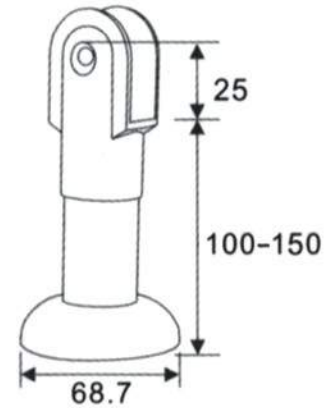

N-302平门(flat)



N-302叠门(folding)

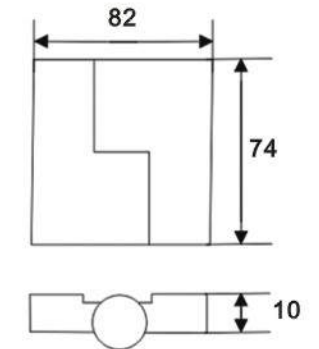

N-306

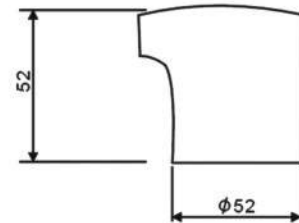

N-015

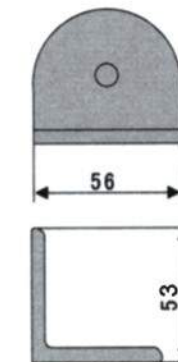

N-304平门(flat)



N-304叠门(folding)

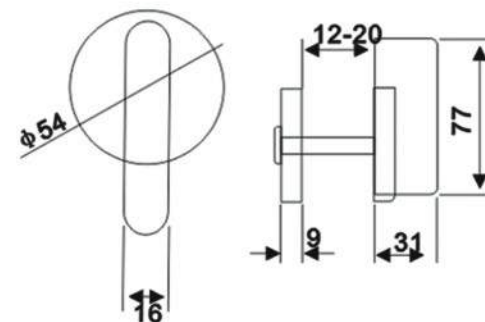

N-005

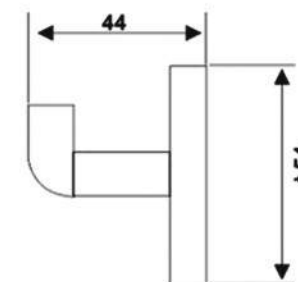



Cubicle Partition Projects Of
Toilet, Fitting Room, Dressing Room
卫生间、试衣间、更衣室隔断方案

XDF-002 Stainless steel series 不锈钢系列

PICTURE OF PRODUCTS

每套标准包装:
STANDARD PACKING LIST
Model:XDF-002

- 1、可调脚座: 2只
Adjustable support leg: 2pcs
- 2、合页: 2个
Hinge: 2pcs
- 3、角码: 12只
Corner fastener: 12pcs
- 4、门锁: 1把
Door lock: 1pcs
- 5、衣帽钩: 1只
Clothes hook: 1pcs
- 6、拉手: 1对
Door knob: 1pair
- 7、厕纸架: 可选
Paper holder: if necessary



T-001

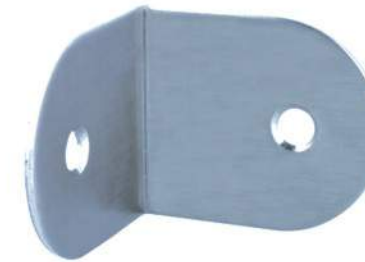
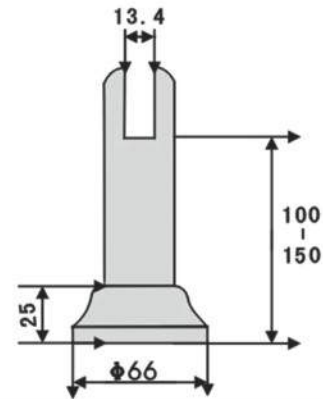

T-003

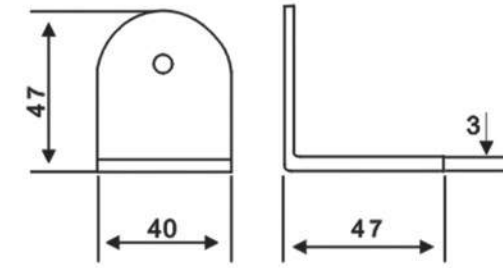

T-002

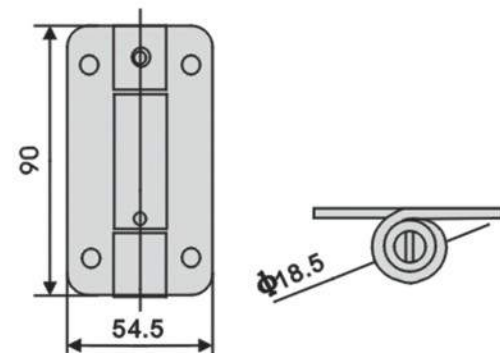

T-006

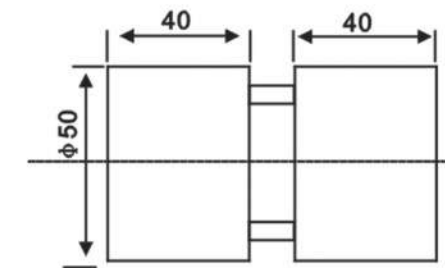

T-005

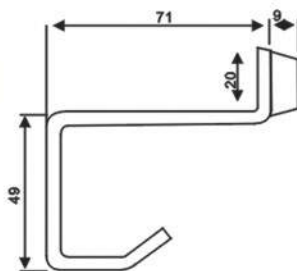

T-004

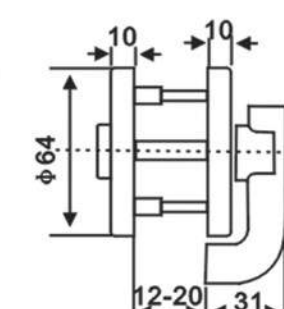

T-007

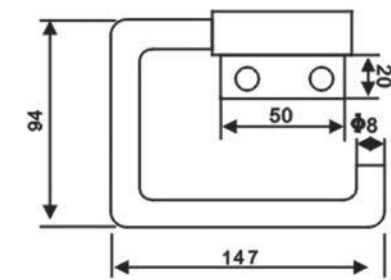

Cubicle Partition Projects Of
Toilet, Fitting Room, Dressing Room
卫生间、试衣间、更衣室隔断方案

XDF-005 Stainless steel #304 series 不锈钢系列

PICTURE OF PRODUCTS



每套标准包装:
STANDARD PACKING LIST
Model:XDF-005

- 1、可调脚座: 2只
Adjustable support leg: 2pcs
- 2、合页: 2个
Hinge: 2pcs
- 3、角码: 12只
Corner fastener: 12pcs
- 4、门锁: 1把
Door lock: 1pcs
- 5、衣帽钩: 1只
Clothes hook: 1pcs
- 6、拉手: 1对
Door knob: 1pair
- 7、厕纸架: 可选
Paper holder: if necessary



E-901

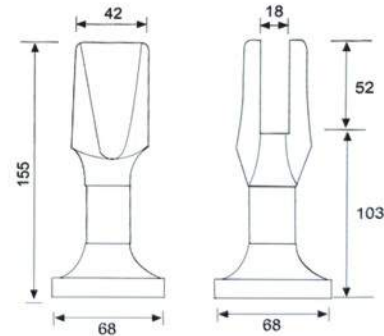

E-055

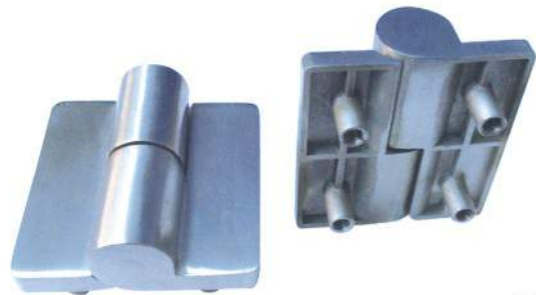
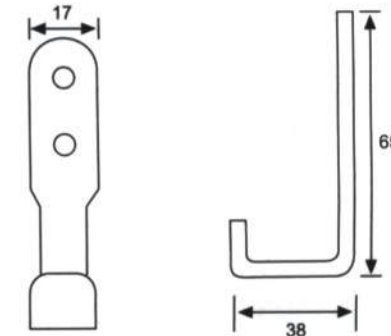

E-052

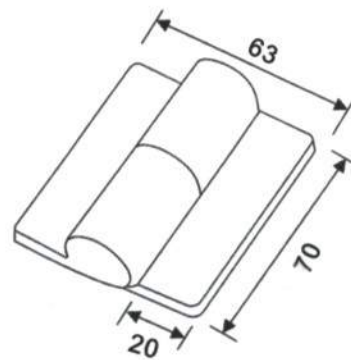

E-053

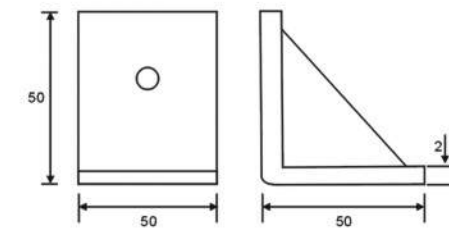

E-010

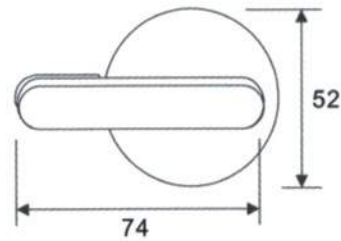

E-106

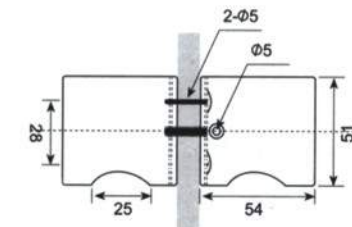

XDF-009
Stainless steel
#304 series
不锈钢系列



PICTURE OF
PRODUCTS

每套标准包装:
STANDARD PACKING LIST
Model:XDF-009

- 1、可调脚座: 2只
Adjustable support leg: 2pcs
- 2、合页: 2个
Hinge: 2pcs
- 3、角码: 12只
Corner fastener: 12pcs
- 4、门锁: 1把
Door lock: 1pcs
- 5、衣帽钩: 1只
Clothes hook: 1pcs
- 6、拉手: 1对
Door knob: 1pair
- 7、厕纸架: 可选
Paper holder: if necessary



E-091

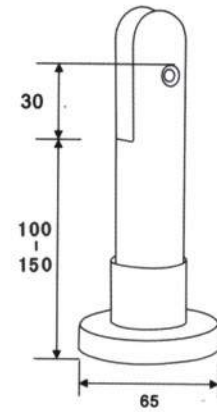

E-098

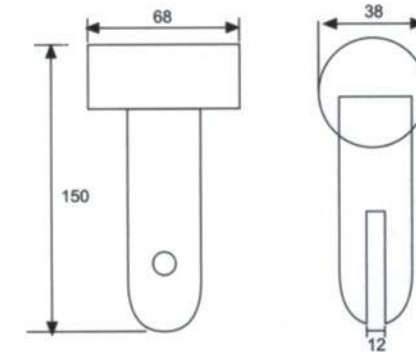

E-046

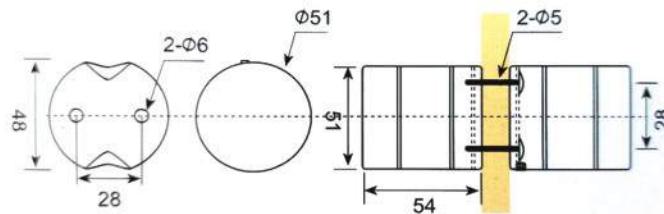

E-132

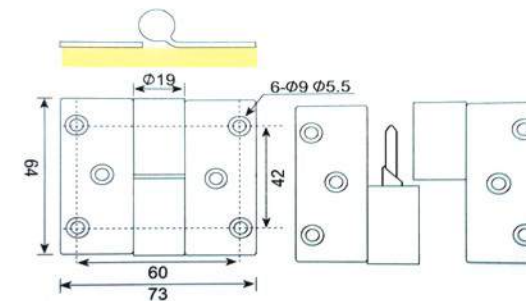

E-094

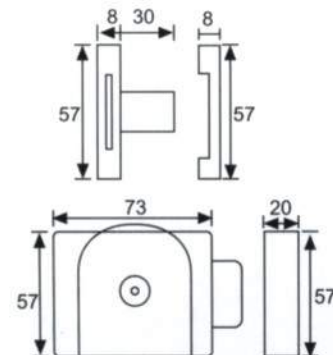

E-123

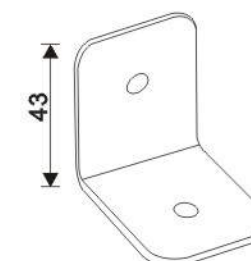

E-016

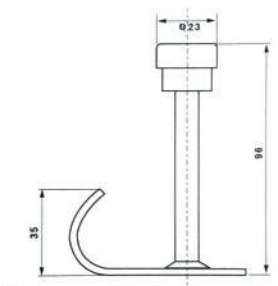

Cubicle Partition Projects Of
Toilet, Fitting Room, Dressing Room
卫生间、试衣间、更衣室隔断方案

XDF-010
Stainless steel
#304 series
不锈钢系列



每套标准包装:
STANDARD PACKING LIST
Model:XDF-010

- 1、可调脚座: 2只
Adjustable support leg: 2pcs
- 2、合页: 2个
Hinge: 2pcs
- 3、角码: 12只
Corner fastener: 12pcs
- 4、门锁: 1把
Door lock: 1pcs
- 5、衣帽钩: 1只
Clothes hook: 1pcs
- 6、拉手: 1对
Door knob: 1pair
- 7、厕纸架: 可选
Paper holder: if necessary



E-031

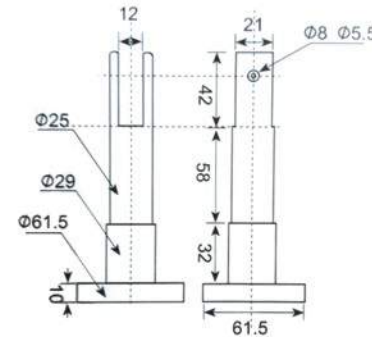

E-034

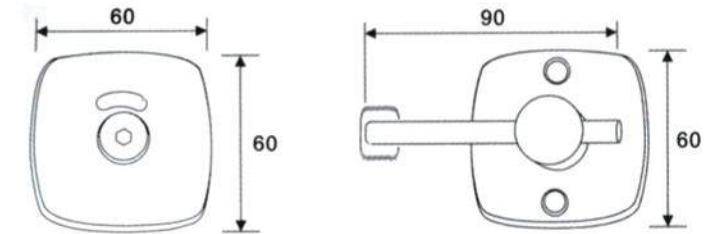

E-032

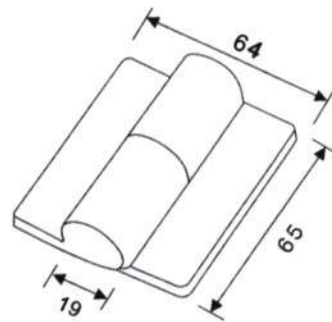

E-036

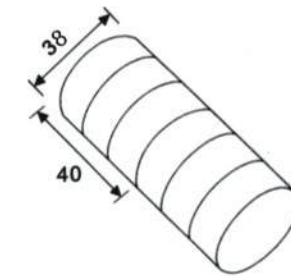

E-038

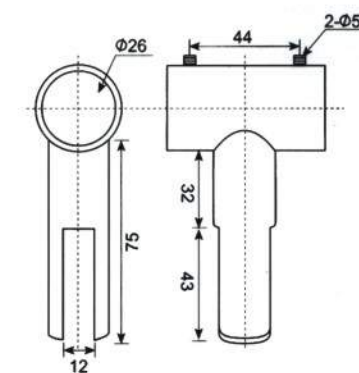

E-009

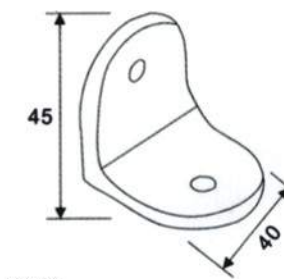

E-035

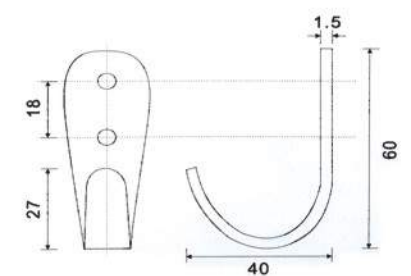

XDF-011
Stainless steel
#304 series
不锈钢系列

PICTURE OF
PRODUCTS

每套标准包装:
STANDARD PACKING LIST
Model:XDF-011

- 1、可调脚座: 2只
Adjustable support leg: 2pcs
- 2、合页: 2个
Hinge: 2pcs
- 3、角码: 12只
Corner fastener: 12pcs
- 4、门锁: 1把
Door lock: 1pcs
- 5、衣帽钩: 1只
Clothes hook: 1pcs
- 6、拉手: 1对
Door knob: 1pair
- 7、厕纸架: 可选
Paper holder: if necessary



E-041

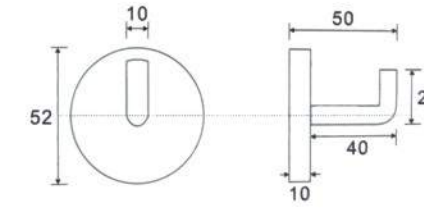
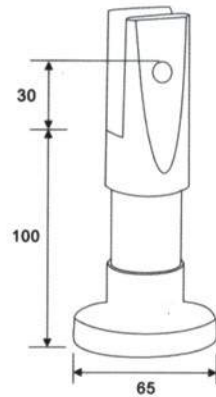

E-155

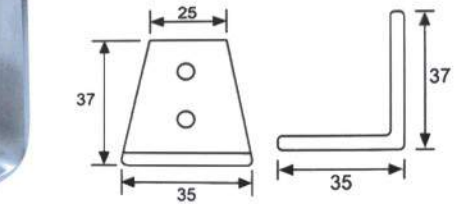

E-133



E-066

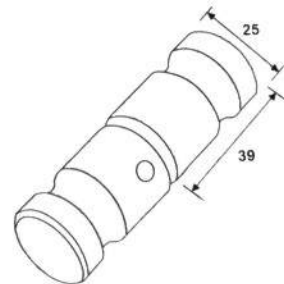

E-044

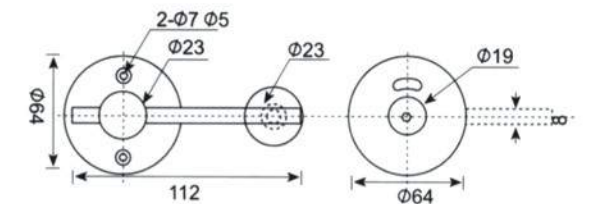

E-042

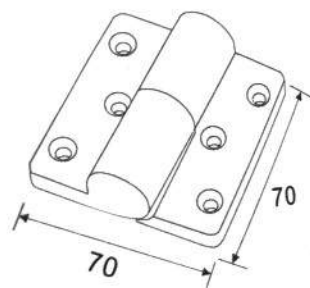

E-048

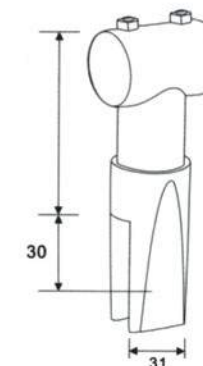

XDF-015 Stainless steel #304 series 不锈钢系列

PICTURE OF PRODUCTS

每套标准包装:
STANDARD PACKING LIST
Model:XDF-015

- 1、可调脚座: 2只
Adjustable support leg: 2pcs
- 2、合页: 2个
Hinge: 2pcs
- 3、角码: 12只
Corner fastener: 12pcs
- 4、门锁: 1把
Door lock: 1pcs
- 5、衣帽钩: 1只
Clothes hook: 1pcs
- 6、拉手: 1对
Door knob: 1pair
- 7、厕纸架: 可选
Paper holder: if necessary



E-131

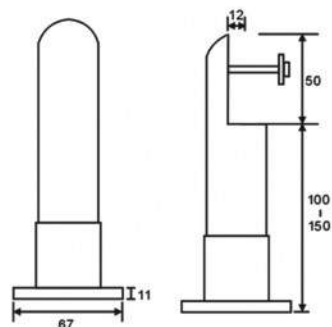

E-135

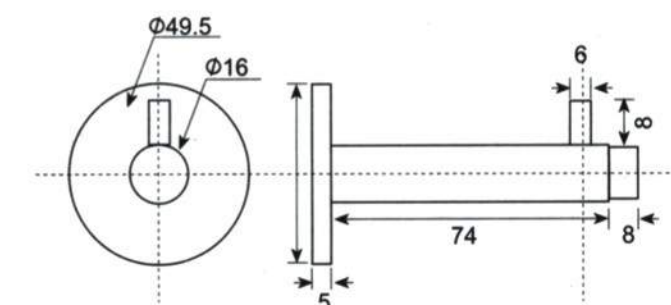

E-056

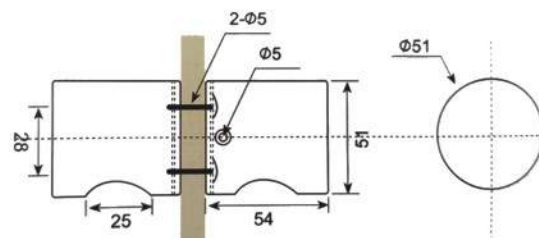

E-143



E-292叠门(folding)



E-292平门(flat)

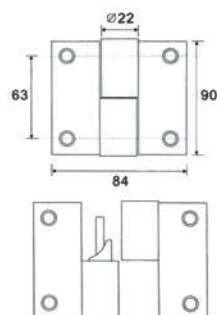

E-994

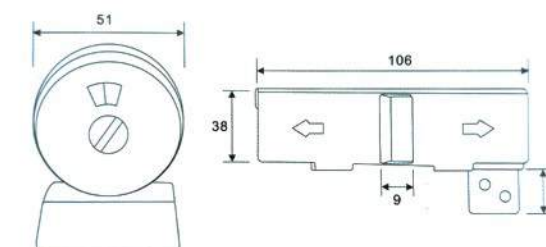

XDF-006
Aluminum
alloy series
铝合金系列



每套标准包装:
STANDARD PACKING LIST
Model:XDF-006

- 1、可调脚座: 2只
Adjustable support leg: 2pcs
- 2、合页: 2个
Hinge: 2pcs
- 3、角码: 12只
Corner fastener: 12pcs
- 4、门锁: 1把
Door lock: 1pcs
- 5、衣帽钩: 1只
Clothes hook: 1pcs
- 6、拉手: 1对
Door knob: 1pair
- 7、厕纸架: 可选
Paper holder: if necessary



E-061

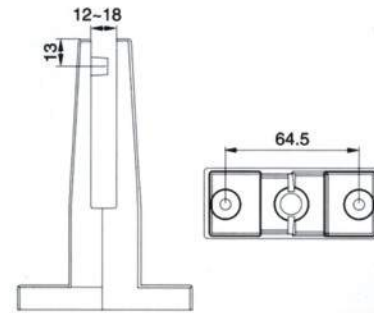

E-062

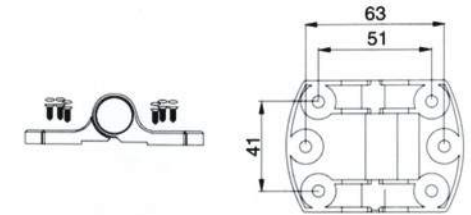

E-063

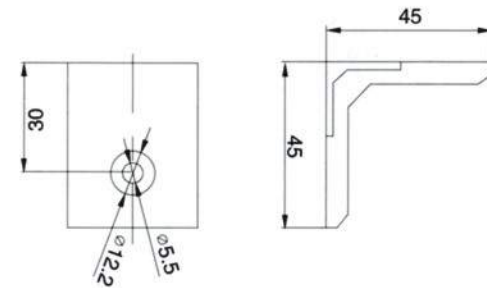

E-065

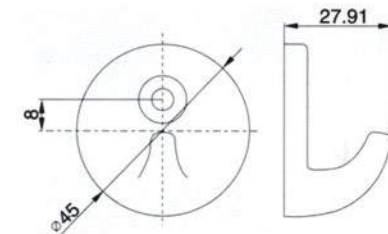

E-064

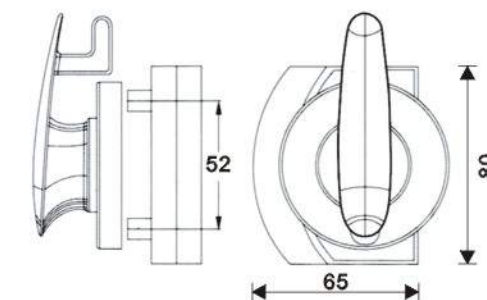



Cubicle Partition Projects Of
Toilet, Fitting Room, Dressing Room
卫生间、试衣间、更衣室隔断方案

XDF-003 Zinc alloy series 锌合金系列

PICTURE OF PRODUCTS



每套标准包装:
STANDARD PACKING LIST
Model:XDF-003

- 1、可调脚座: 2只
Adjustable support leg: 2pcs
- 2、合页: 2个
Hinge: 2pcs
- 3、角码: 12只
Corner fastener: 12pcs
- 4、门锁: 1把
Door lock: 1pcs
- 5、衣帽钩: 1只
Clothes hook: 1pcs
- 6、拉手: 1对
Door knob: 1pair
- 7、厕纸架: 可选
Paper holder: if necessary



Z-001

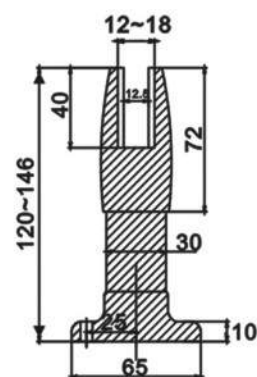

Z-002

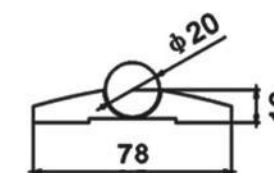
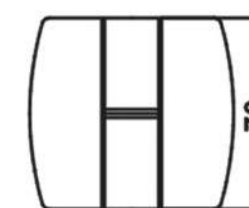

Z-004

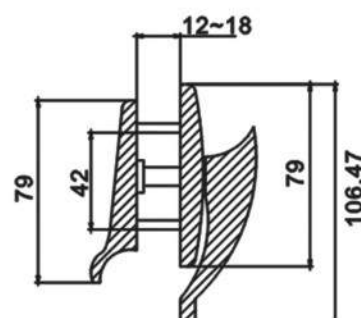

Z-003

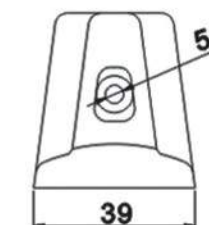

Z-005

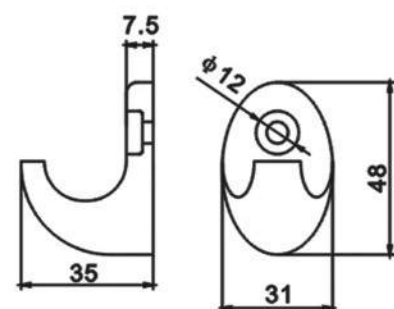

Z-007

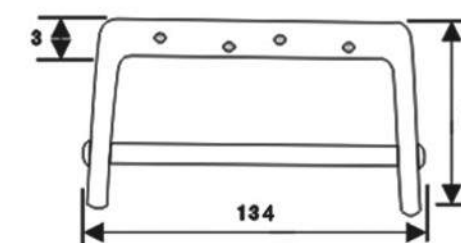

XDF-007
Zinc alloy
series
锌合金系列



每套标准包装:
STANDARD PACKING LIST
Model:XDF-007

- 1、可调脚座: 2只
Adjustable support leg: 2pcs
- 2、合页: 2个
Hinge: 2pcs
- 3、角码: 12只
Corner fastener: 12pcs
- 4、门锁: 1把
Door lock: 1pcs
- 5、衣帽钩: 1只
Clothes hook: 1pcs
- 6、拉手: 1对
Door knob: 1pair
- 7、厕纸架: 可选
Paper holder: if necessary



E-071

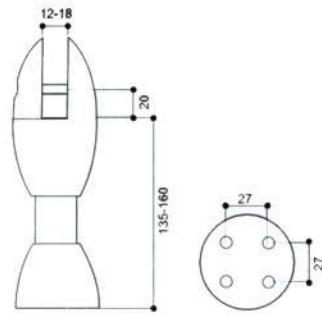

E-075

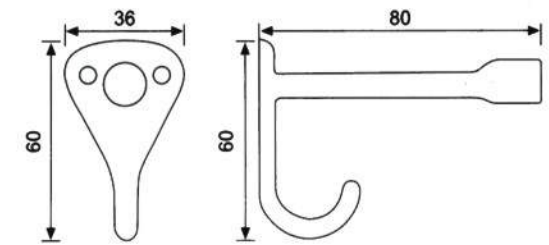

E-074

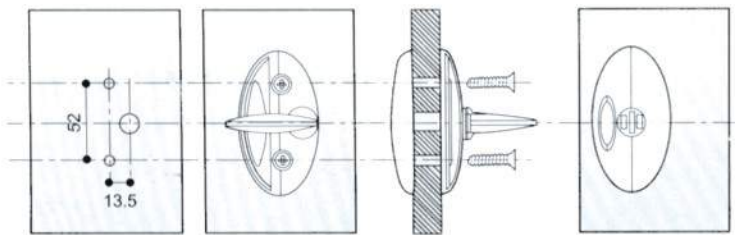

E-072

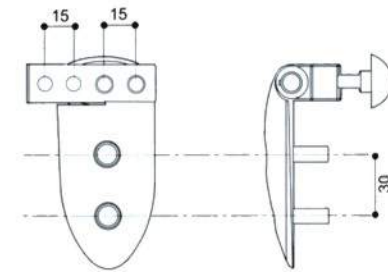

E-073

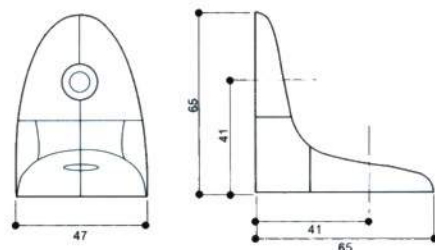

E-078

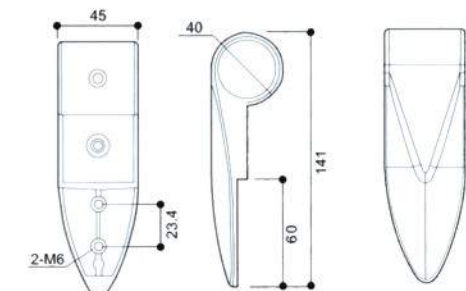

XDF-008
Zinc alloy
series
锌合金系列



PICTURE OF
PRODUCTS

每套标准包装:
STANDARD PACKING LIST
Model:XDF-008

- 1、可调脚座: 2只
Adjustable support leg: 2pcs
- 2、合页: 2个
Hinge: 2pcs
- 3、角码: 12只
Corner fastener: 12pcs
- 4、门锁: 1把
Door lock: 1pcs
- 5、衣帽钩: 1只
Clothes hook: 1pcs
- 6、拉手: 1对
Door knob: 1pair
- 7、厕纸架: 可选
Paper holder: if necessary



E-081

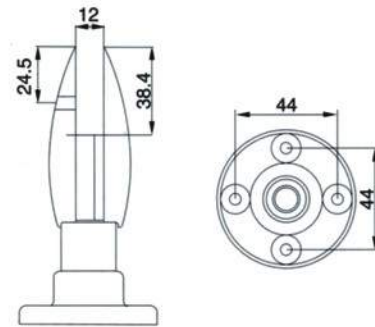

E-082

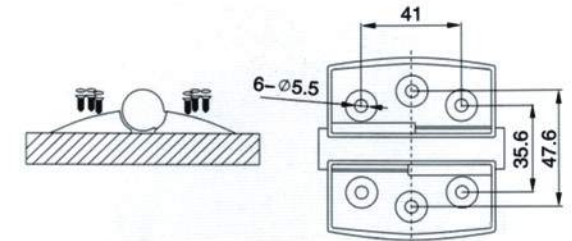

E-083

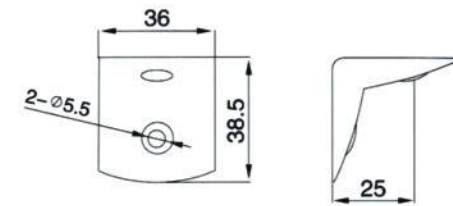

E-085

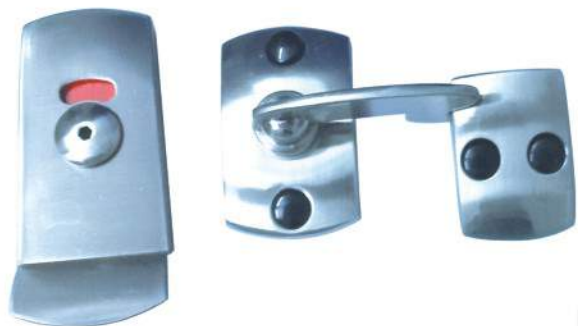
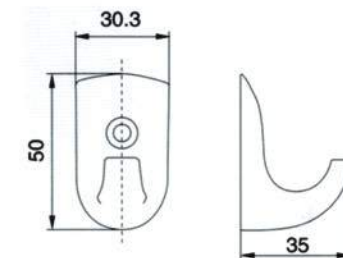

E-084

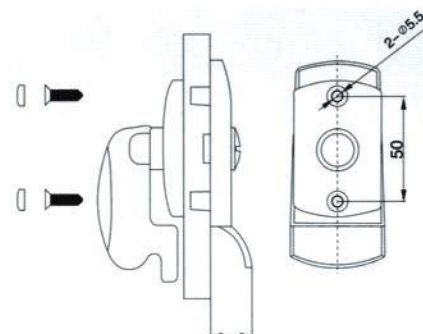

PICTURE OF PRODUCTS

XDF-016 Zinc alloy series 锌合金系列



每套标准包装:
STANDARD PACKING LIST
Model:XDF-016

- 1、可调脚座: 2只
Adjustable support leg: 2pcs
- 2、合页: 2个
Hinge: 2pcs
- 3、角码: 12只
Corner fastener: 12pcs
- 4、门锁: 1把
Door lock: 1pcs
- 5、衣帽钩: 1只
Clothes hook: 1pcs
- 6、拉手: 1对
Door knob: 1pair
- 7、厕纸架: 可选
Paper holder: if necessary



E-001

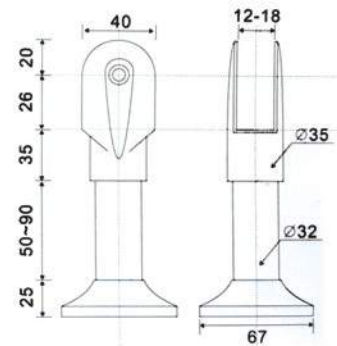

E-011B

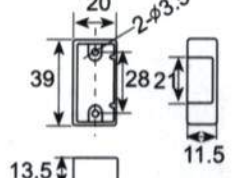
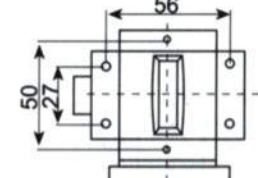
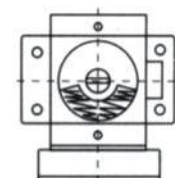

E-145



E-426

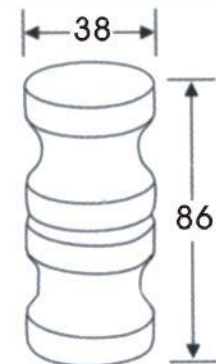

E-009

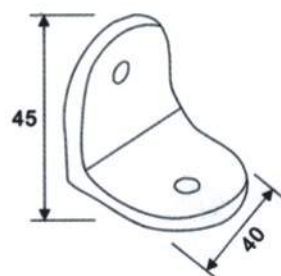

E-005

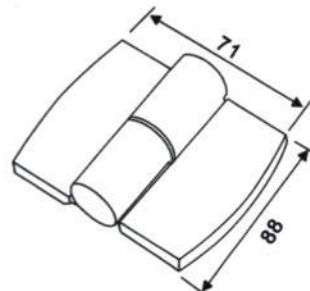

E-108

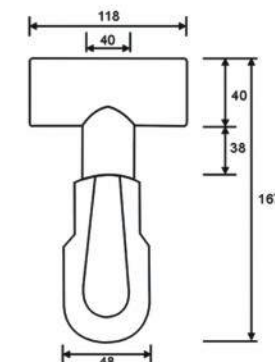

Cubicle Partition Projects Of
Toilet, Fitting Room, Dressing Room
卫生间、试衣间、更衣室隔断方案

XDF-020
Stainless steel
#304 series
不锈钢系列

PICTURE OF
PRODUCTS

XDF-021
Stainless steel
#304 series
不锈钢系列



E-291



E-423



E-205



E-721



E-010B



E-872



E-506



E-862



E-165



E-484



E-218



E-976



E-433



Cubicle Partition Projects Of
Toilet, Fitting Room, Dressing Room
卫生间、试衣间、更衣室隔断方案

XDF-022
Stainless steel
#304 series
不锈钢系列



PICTURE OF PRODUCTS

XDF-023
Stainless steel
#304 series
不锈钢系列



E-391

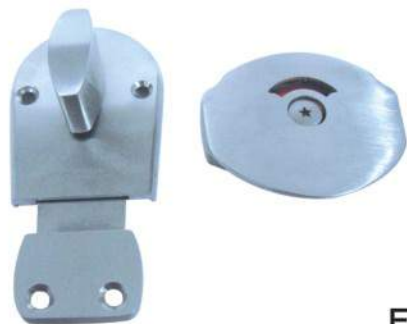

E-664



E-201



E-503



E-762



E-016



E-606



E-242



E-156



E-423



E-318



N-054SS



E-208

XDF-024
Stainless steel
#304 series
不锈钢系列

PICTURE OF
PRODUCTS



每套标准包装:
STANDARD PACKING LIST
Model:XDF-017

- 1、可调脚座: 2只
Adjustable support leg: 2pcs
- 2、合页: 2个
Hinge: 2pcs
- 3、角码: 12只
Corner fastener: 12pcs
- 4、门锁: 1把
Door lock: 1pcs
- 5、衣帽钩: 1只
Clothes hook: 1pcs
- 6、拉手: 1对
Door knob: 1pair
- 7、厕纸架: 可选
Paper holder: if necessary



T-001



T-002



E-010



E-862



E-175



E-058



E-059



E-976



T-003



E-070



E-080

Cubicle Partition Projects Of
Toilet, Fitting Room, Dressing Room
卫生间、试衣间、更衣室隔断方案



**PICTURE OF
PRODUCTS**

XDF-026
Stainless steel
#304 series
不锈钢系列

XDF-027
Stainless steel
#304 series
不锈钢枪黑系列



E-004



E-175



E-451



E-874



E-392



E-513



E-622



E-345



T-004B



E-426



E-543

Cubicle Partition Projects Of
Toilet, Fitting Room, Dressing Room
卫生间、试衣间、更衣室隔断方案



XDF-025
Aluminum
alloy series
铝合金系列

PICTURE OF
PRODUCTS

XDF-018
Zinc alloy
series
锌合金系列



E-771



E-775



Z-101



Z-104



E-774



E-773



Z-102



Z-105



E-772



Z-103



Z-106



E-501



T-001



E-041



Z-001



E-191



E-391

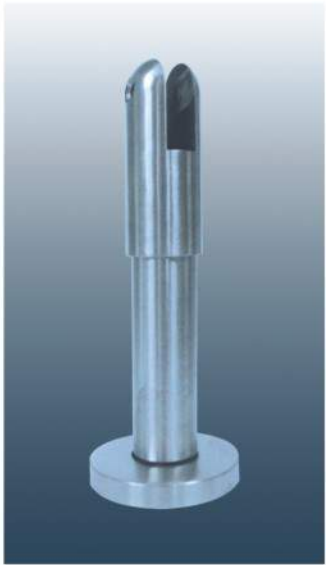

E-721



E-861



E-061



E-131



E-201



E-004



E-002



E-031



E-091



E-051



E-771



E-611



E-431



E-231



E-071



E-901



E-911



E-841



E-221



E-211



E-171



E-441



E-461



E-811



E-001



E-031B



E-291



E-821



E-831



E-451



E-421



Z-201



Z-101



E-003



N-011



N-009



N-001



N-008



N-071



N-010



E-181

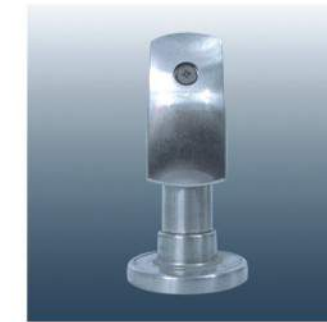

E-081

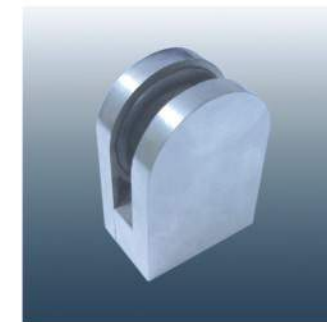

E-161

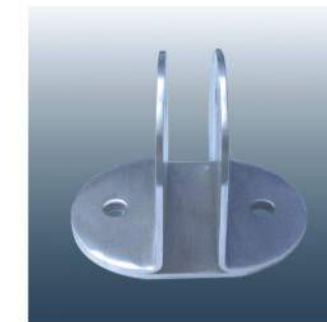

E-111

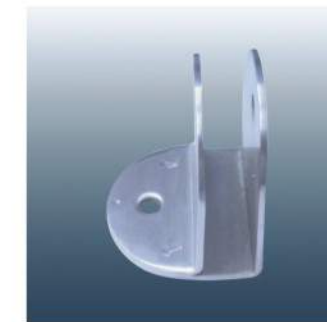

E-101

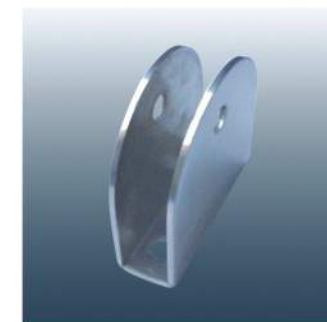

E-151

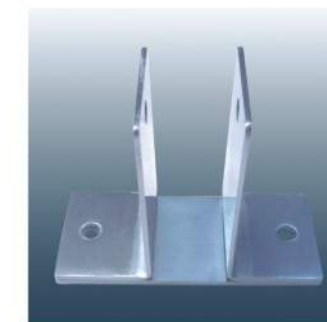

E-141



E-411



E-241

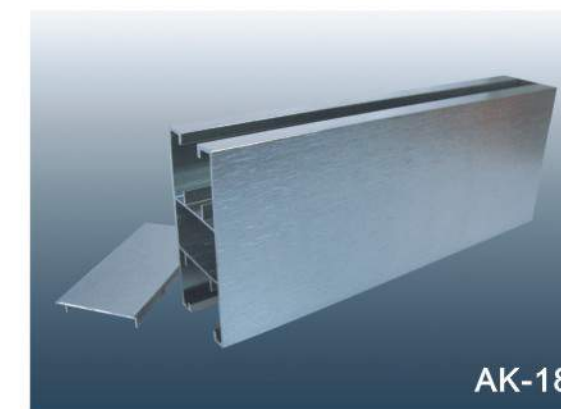

AK-18



T-002



E-862



E-042

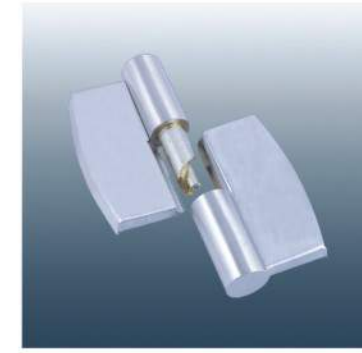

E-005



E-792叠门(folding)



E-792平门(flat)

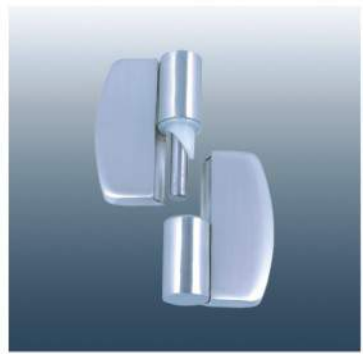

Z-002



E-172

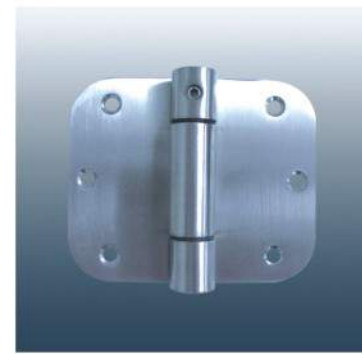

E-732

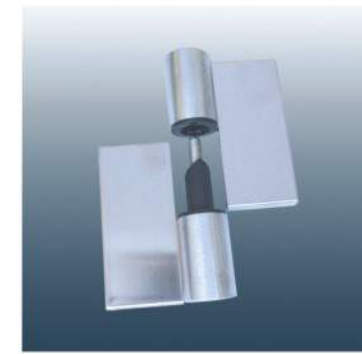

E-032



E-006

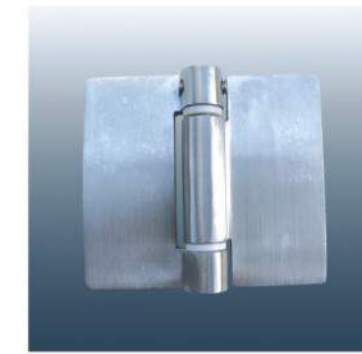

E-742



E-242

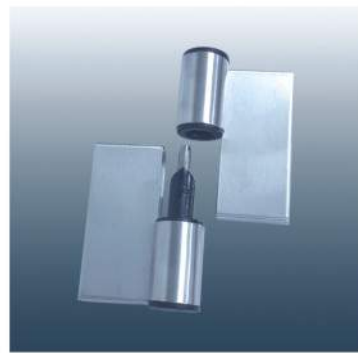

E-392



E-762



E-782



E-262



E-752



E-872



E-292叠门(folding)



E-292平门(flat)

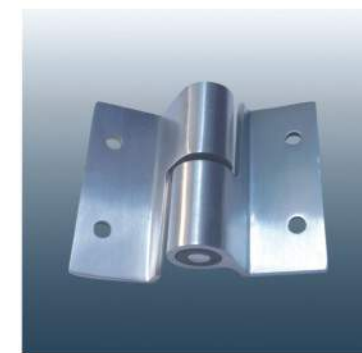

E-092



E-132



E-722 (black)

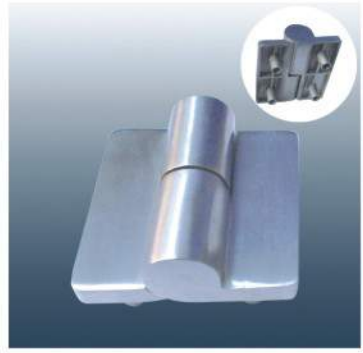

E-052

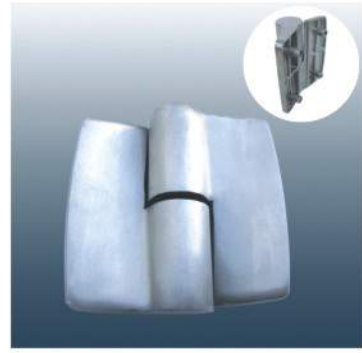

E-272

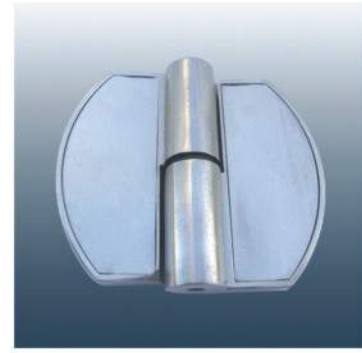

E-222

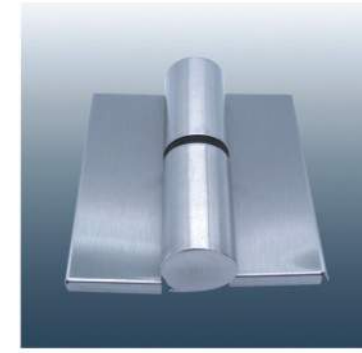

E-912

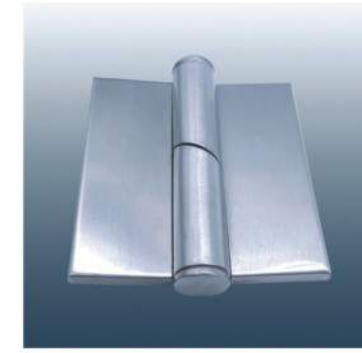

E-922

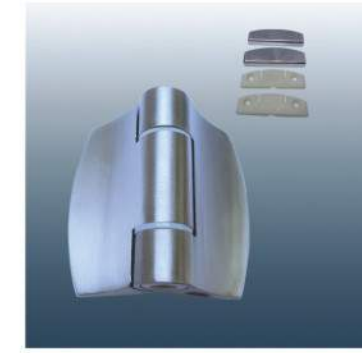

E-642



E-892



E-802

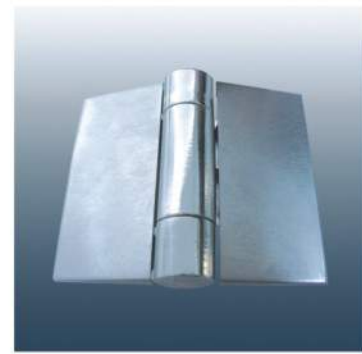

E-312

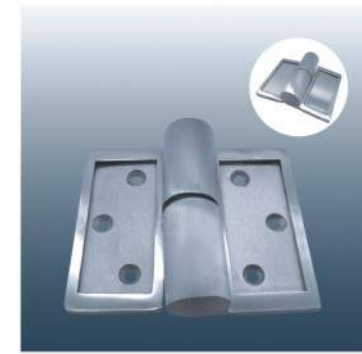

E-672

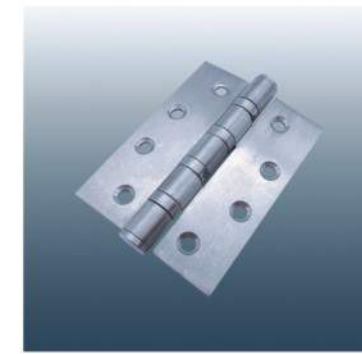

E-602

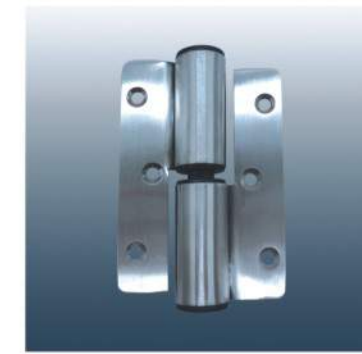

E-652

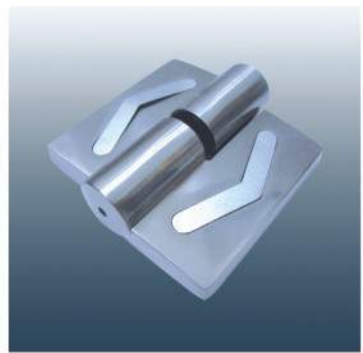

E-722 (silver)



E-252

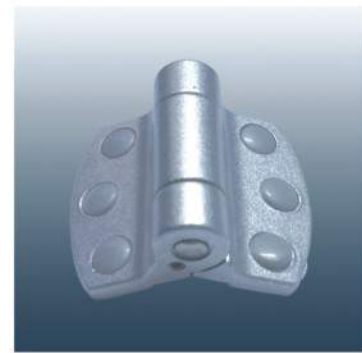

E-062

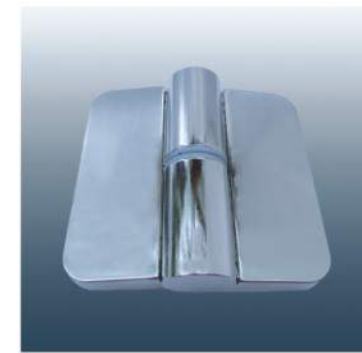

E-632



E-662



T-002B



E-082



E-162A

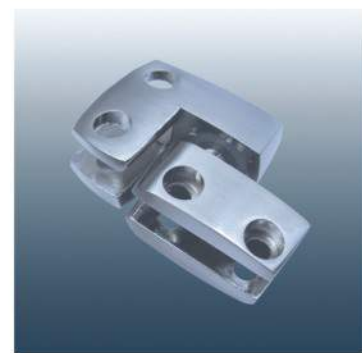

E-162B

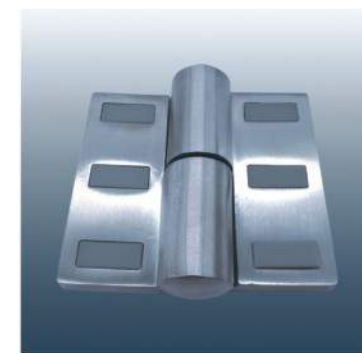

E-942

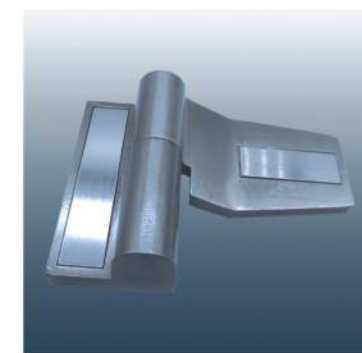

E-682



E-692



E-772

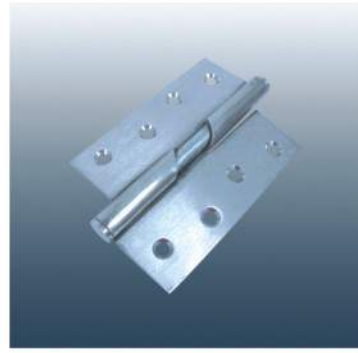

E-008



E-007

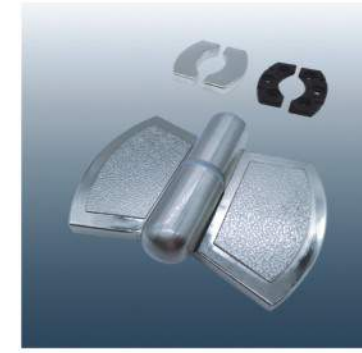

E-612

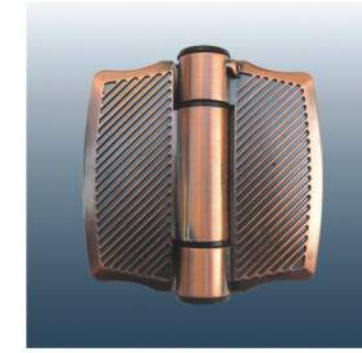

Z-202



E-232

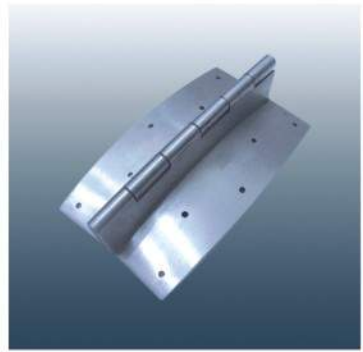

E-282



E-202



E-952



N-452



N-052



N-002



E-102



E-112



E-122



N-012



E-192



N-832



E-142



E-072



E-192

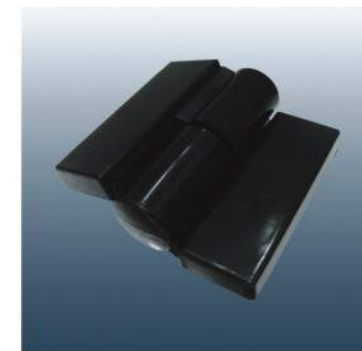

N-302叠门(folding)



N-302平门(flat)



E-622



T-003



Z-003

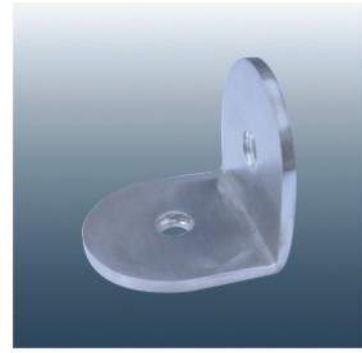

E-043

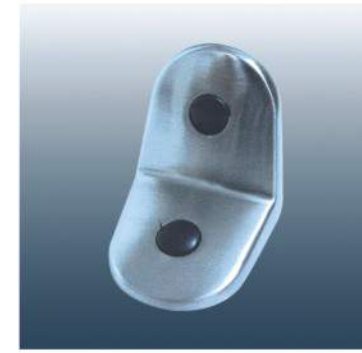

E-153

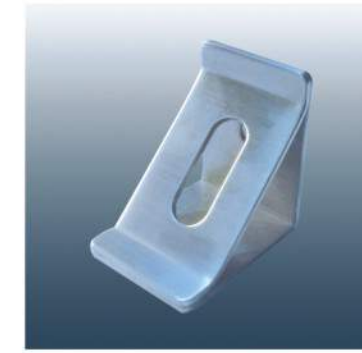

E-053

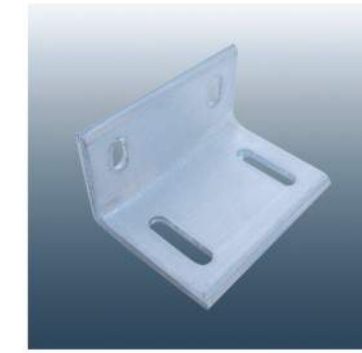

P-613



E-009

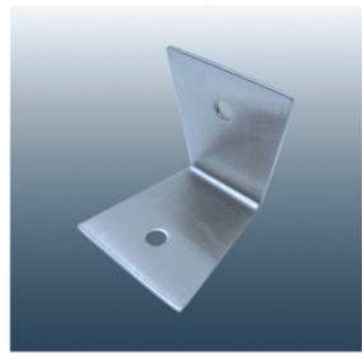

E-433



E-423



E-073

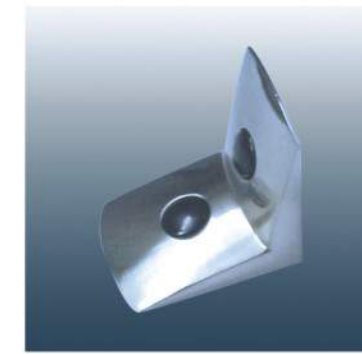

E-083

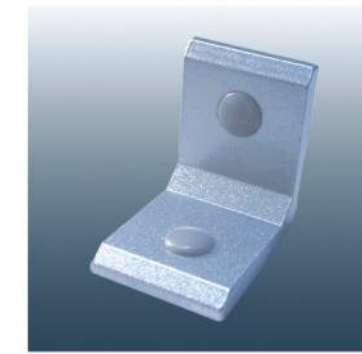

E-063

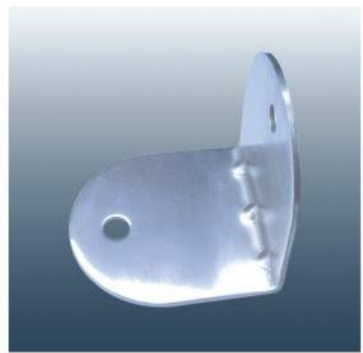

E-093



E-773



E-503



E-113

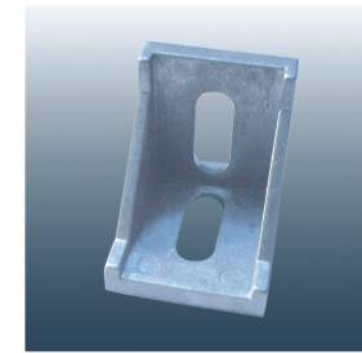

E-103



E-163



E-513



E-143

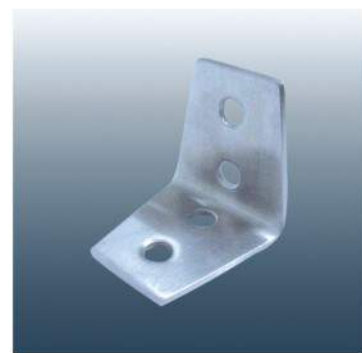

E-133



E-123



E-533

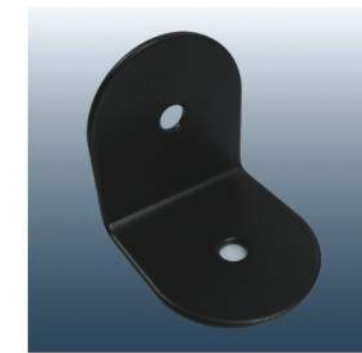

E-543



N-014



N-073



N-053



N-003



N-063

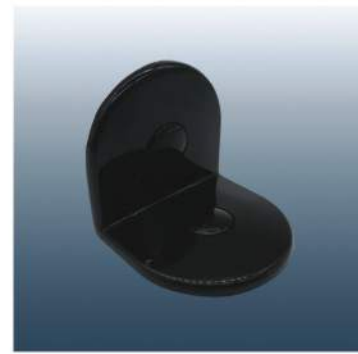

N-015



Z-203



Z-103

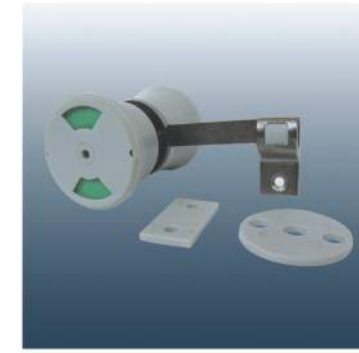

N-054



N-304叠门(folding)



N-304平门(flat)



N-016



N-017

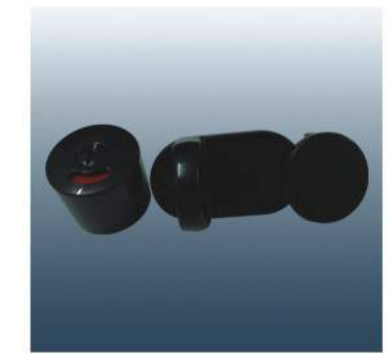

N-084



N-074



N-004



T-004



T-004B



E-010

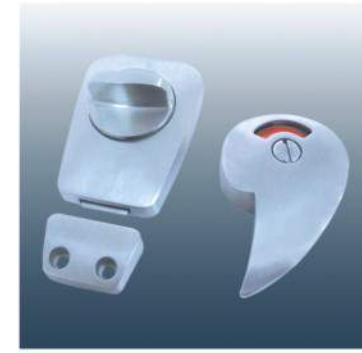

E-164



E-464



E-144

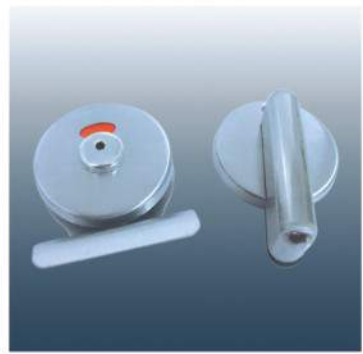

E-174

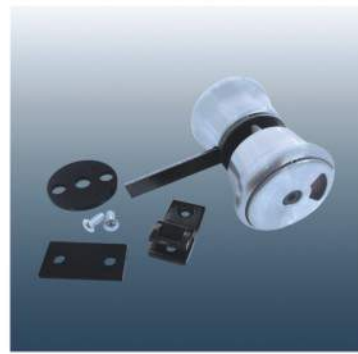

N-054SS



Z-004

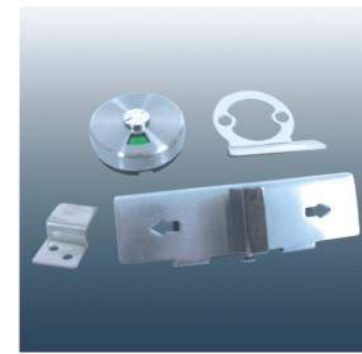

E-994



E-054

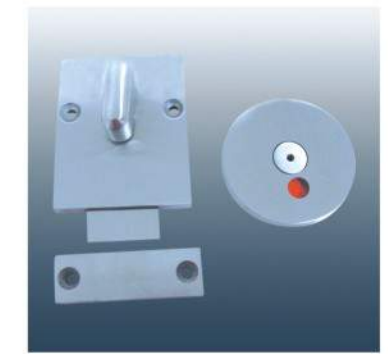

E-414



E-094

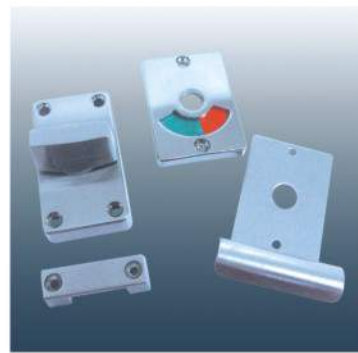

E-011B



E-011



E-012A

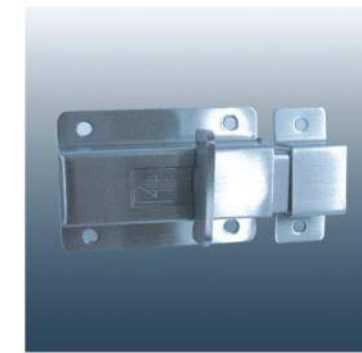

E-012B

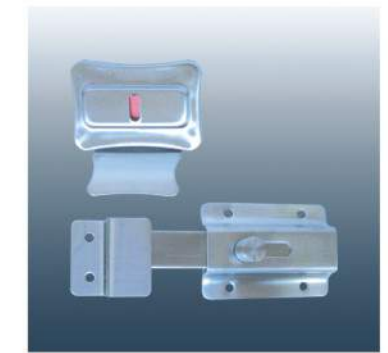

E-784

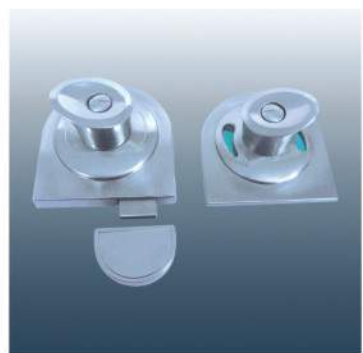

E-474



E-154



E-010B

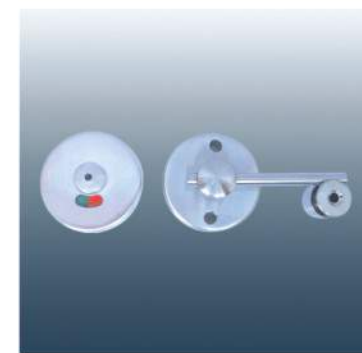

E-044



E-034

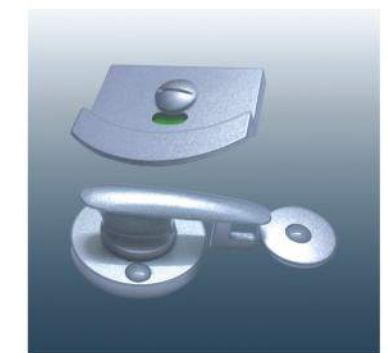

E-064



E-084



E-424

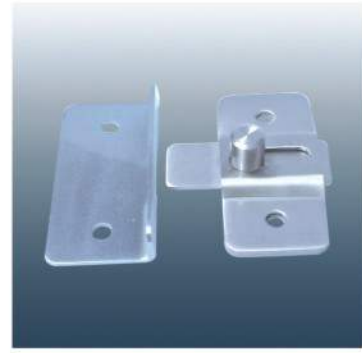

E-134



E-814



E-824

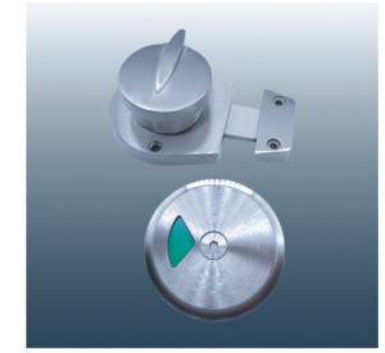

E-834

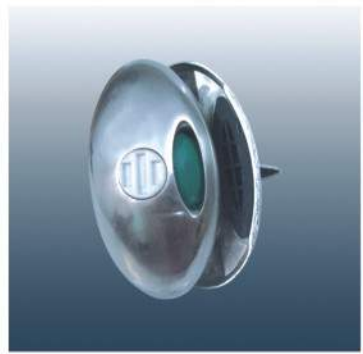

E-074



E-774



E-904

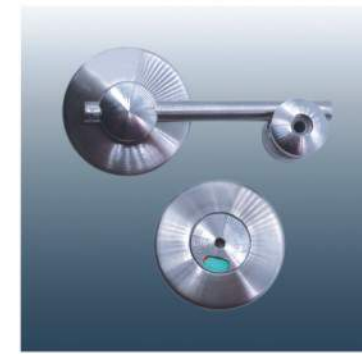

E-844

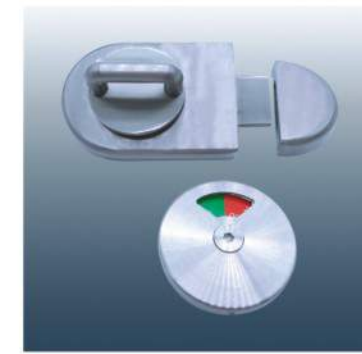

E-854



E-864



E-914

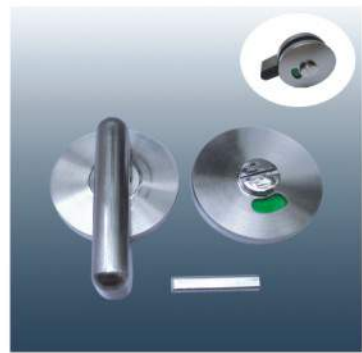

E-010D



E-704



E-884



E-894



E-874

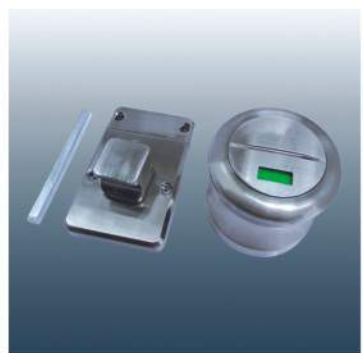

E-714

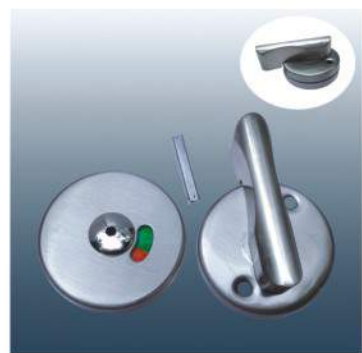

E-734

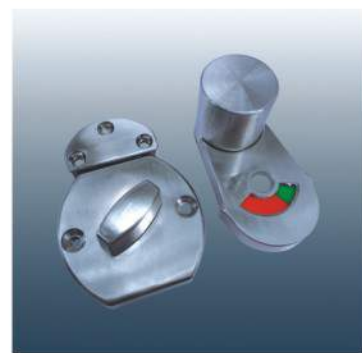

E-804



Z-204

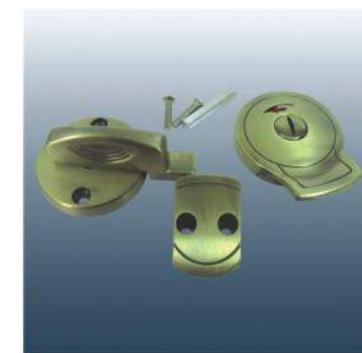

Z-104

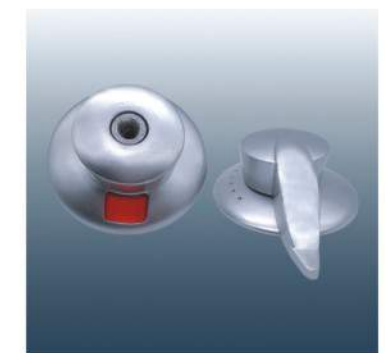

E-924



E-108



E-098



E-048



E-058



E-218



E-038



E-628



E-318



E-548



E-068



E-078



E-208



N-068



N-058



N-108



N-078



N-021(big)



N-020(middle)



N-005(small)

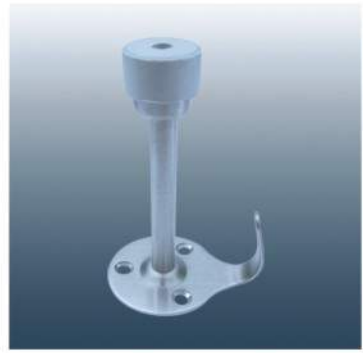

E-016

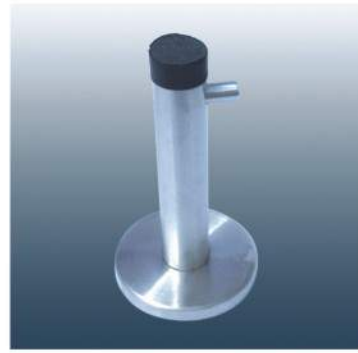

E-135



E-175

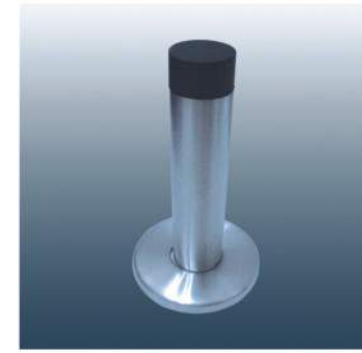

E-185



E-145

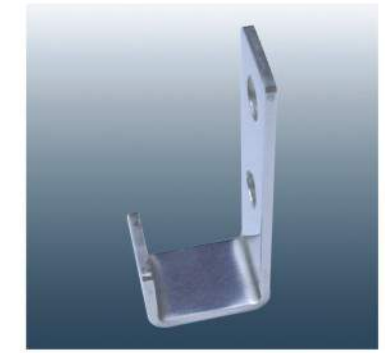

E-095

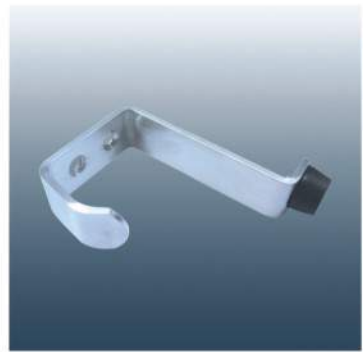

T-005



E-055



E-165



E-045



E-775

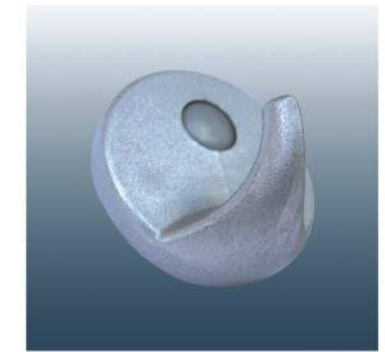

E-065



E-205



E-155

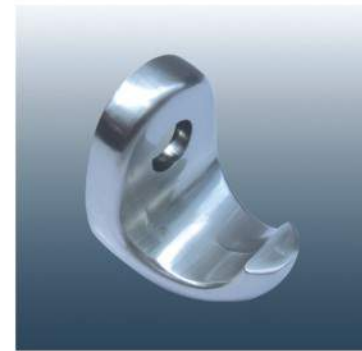

Z-005



E-305

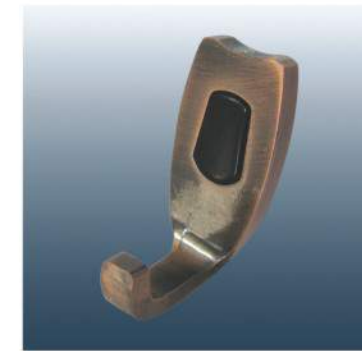

Z-205



E-345

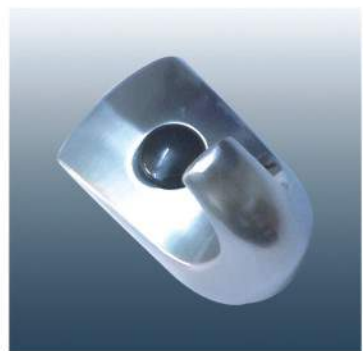

E-085



E-035



E-075



Z-105



N-065



N-055



E-059



E-089

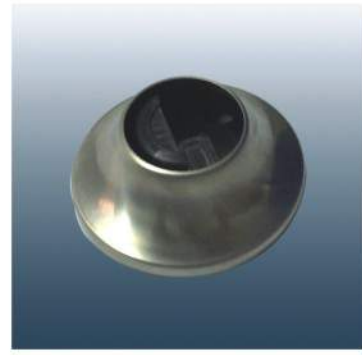

E-079

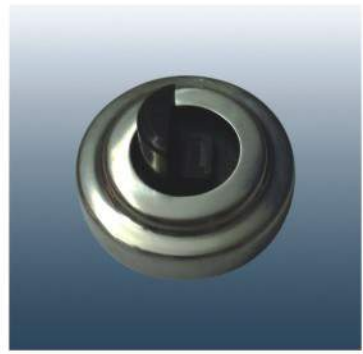

E-049



N-059



N-069



N-079

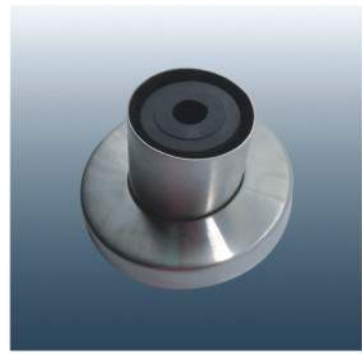

E-069

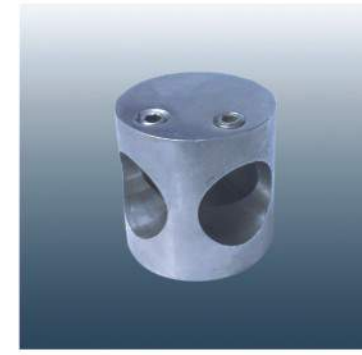

E-070

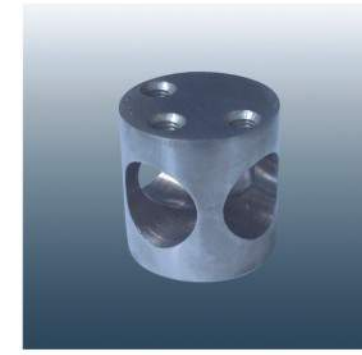

E-080



E-040

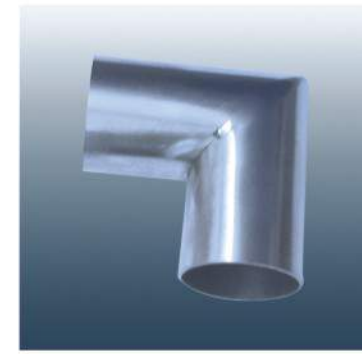

E-050



N-040



N-050



N-430



N-440

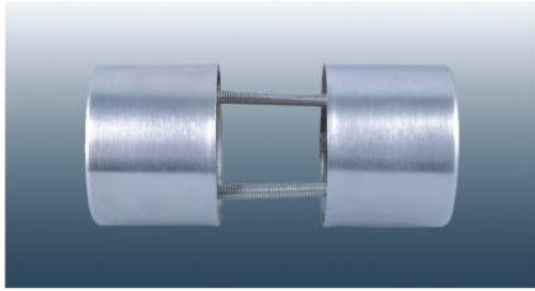

T-006

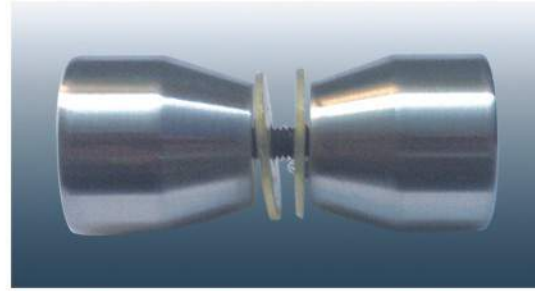

E-096

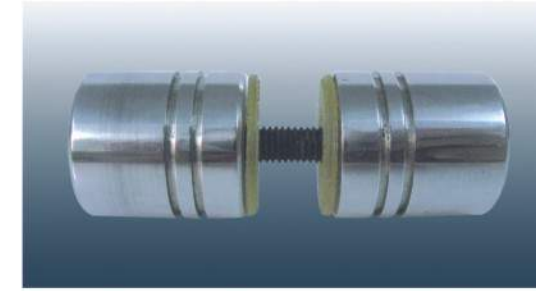

E-014

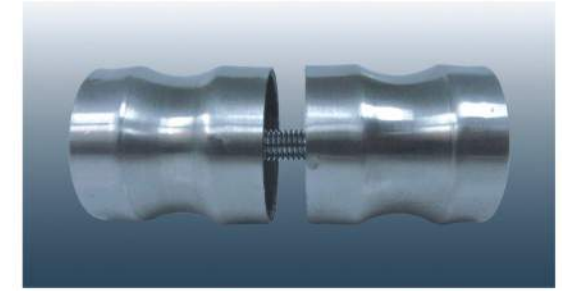

E-426



E-066

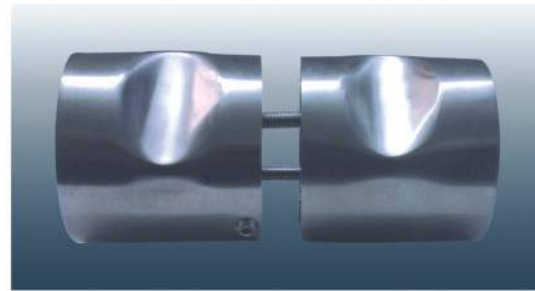

E-056



E-396



E-386

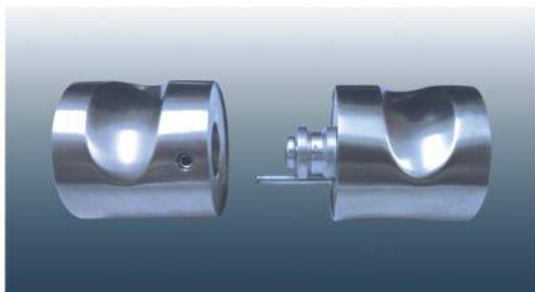

E-106

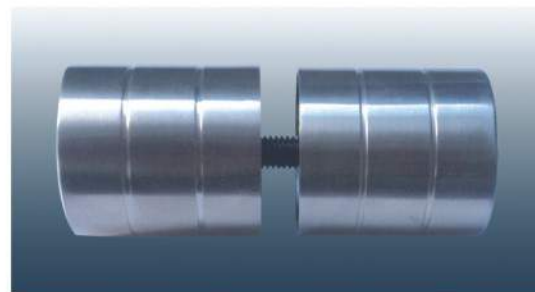

E-036

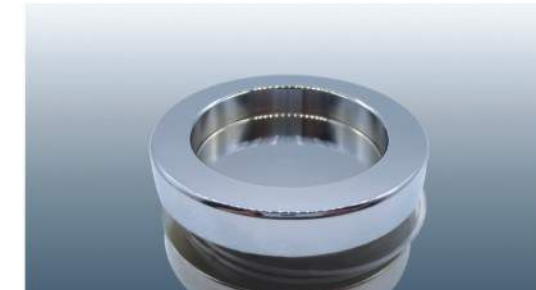

E-616



E-626

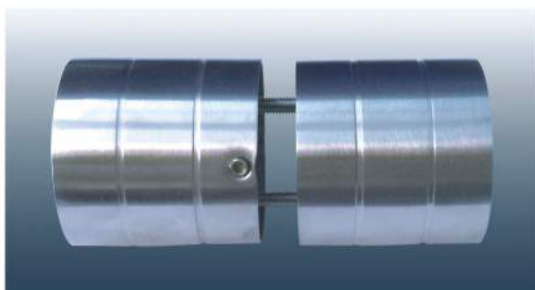

E-046

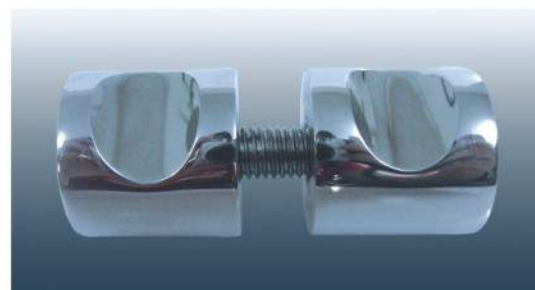

E-013



E-416



DK-01



E-015

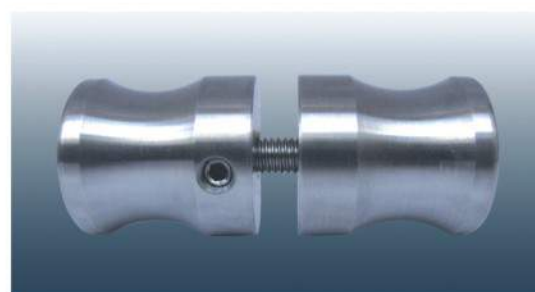

E-976

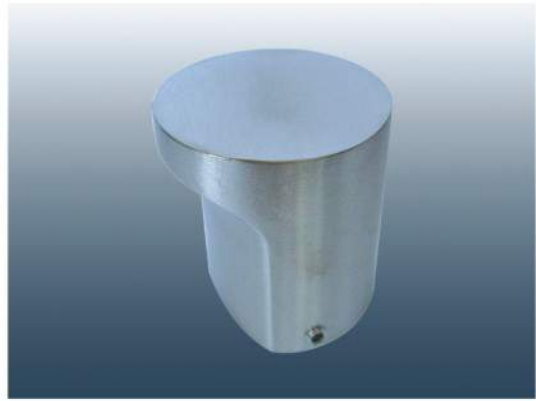

E-506

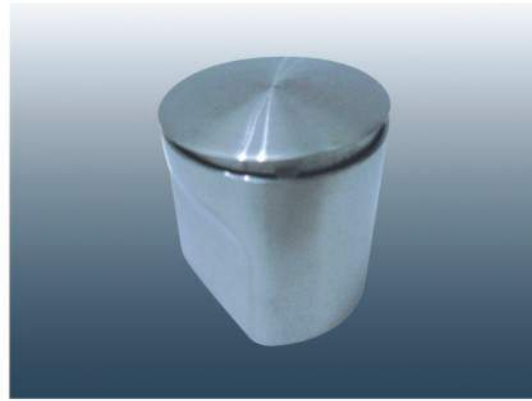

E-606

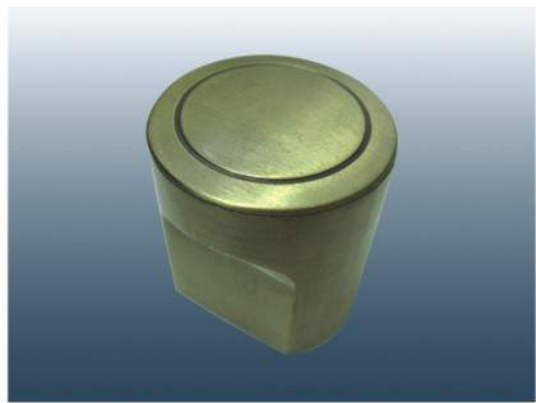

Z-106



E-206



N-306



N-006

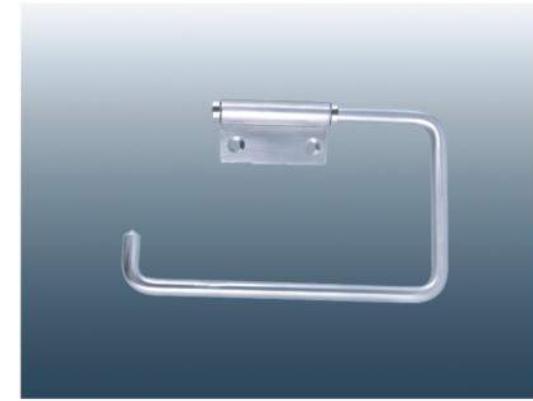

T-007



N-007



Z-007



P-014



P-018

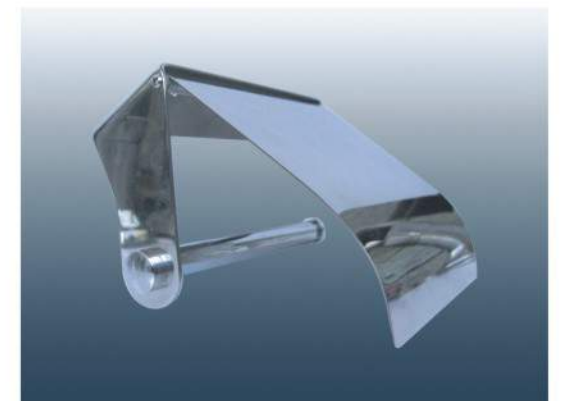

E-907



P-012
paper holder



P-013
paper holder



Light beige 932 (荷花白)



Black 816 (纯黑)



Pure white 819 (暖白)



Blue 38019 (湛蓝)



Gray 927 (灰色)



Light pink 859 (浅粉红)



Light green 879 (浅豆绿)



Beech 32726 (白桦)



Oak 39966 (橡木)



Walnut brown 619107 (胡桃)



Maple 0630 (北美枫木)



B

内墙系统
Wall Cladding

Wall Cladding System
挂墙系统

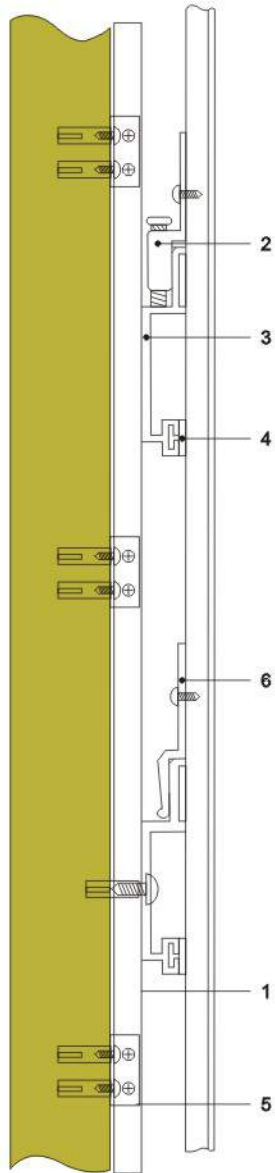
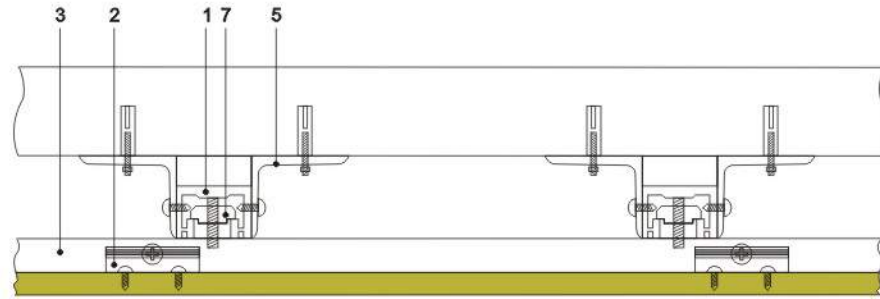

Section view of horizontal division
兴蒂丰挂墙系统横剖面图

分部细节 Section Details

- 1、竖龙骨 Vertical shape rail
- 2、可调节码 Adjustable jump piece
- 3、U型横龙骨 U-shape rail
- 4、紧密胶条 Sealing rubber
- 5、L型固定码 L shaped fastener
- 6、固定码 Fixed Jump piece
- 7、龙骨连接片 Rail junction



Wall cladding assembly sketch map 挂墙拼装示意图

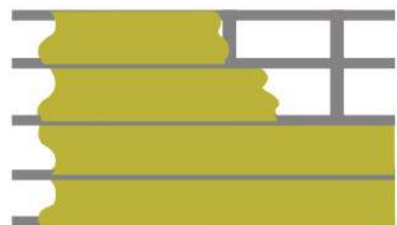

Wall cladding assembly sketch map 挂墙拼装示意图

- 1、固定码 Fixed Jump piece (P-610)
- 2、可调节码 Adjustable Jump piece (P-611)
- 3、竖龙骨 Vertical shape rail (P-620)
- 4、横龙骨 U shape rail (P-612)
- 5、角码 Corner bracket (P-613)
- 6、效果图 Assembly photo
- 7、胶条 sealing rubber



P-610



P-611



P-620

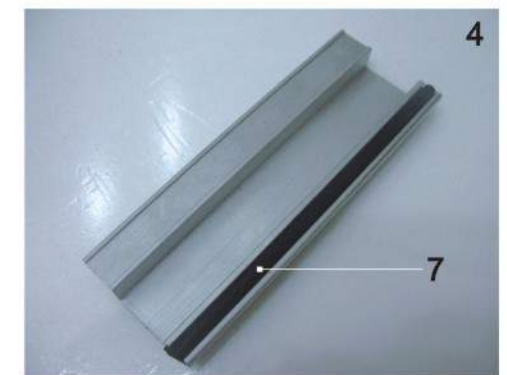

P-612

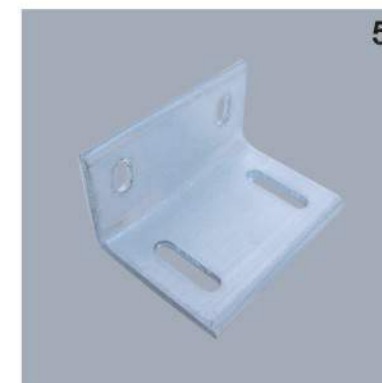

P-613



Assembly photo

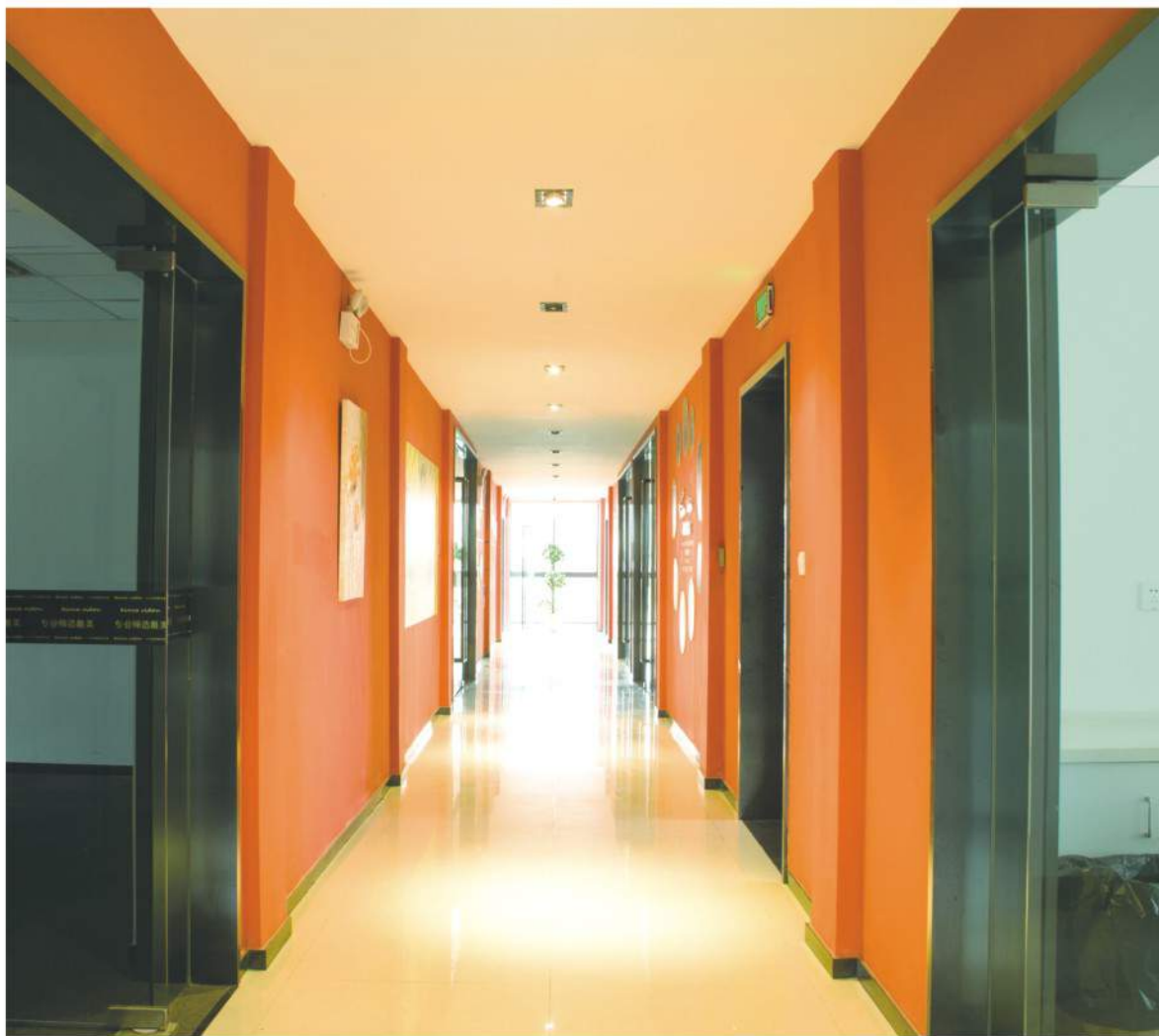



空间。几何物语
Space. Geometric materials

留恋空间，是一种与生俱来的习惯，
像隐藏在我们身上……
独一无二的美学因子，随圆方几何，
勾勒居所表情，格调悠扬。

Love space is inherent habit,
just like the unique aesthetic factor
hidden in us, with round, square
and geometry,
show the expression of living space
with graceful style.



储物柜系统
Lockers System



E-102



E-112



E-122



E-674



E-764



E-754



E-182



E-504

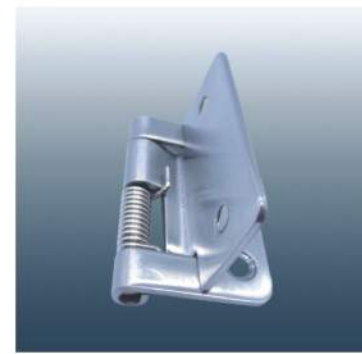

E-952



E-744

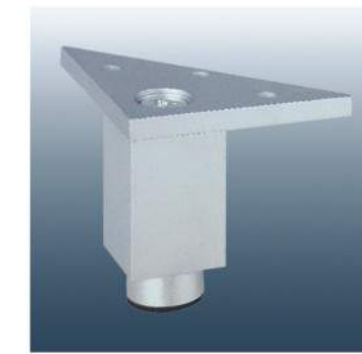

E-931



E-941



DK-01



E-163



E-664

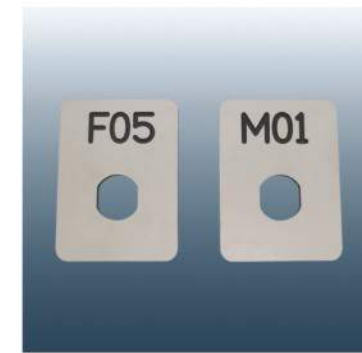

R-002 Number plate

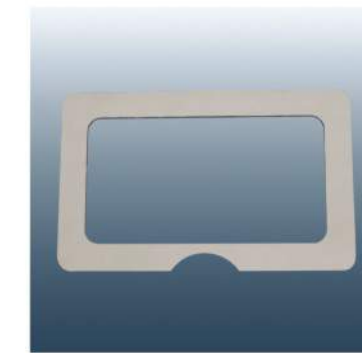

R-003 Number plate



R-004 Number plate



E-214



E-634



R-001 Rubber

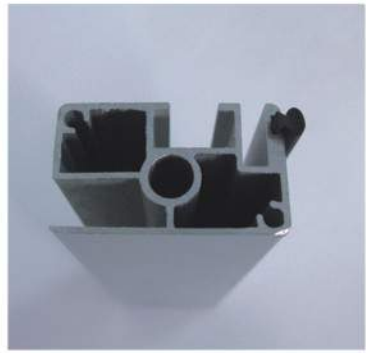

A-032

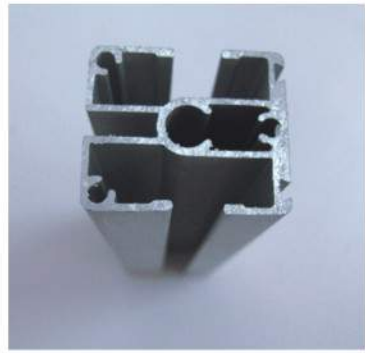

A-033

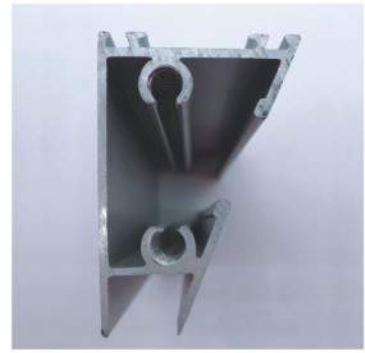

A-034

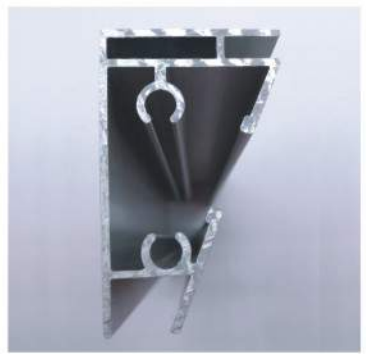

A-035

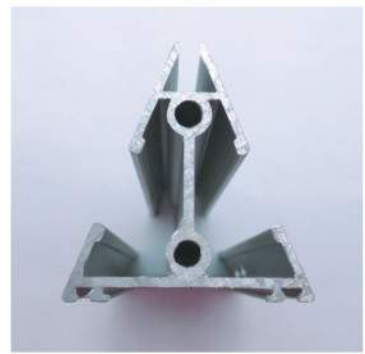

A-036

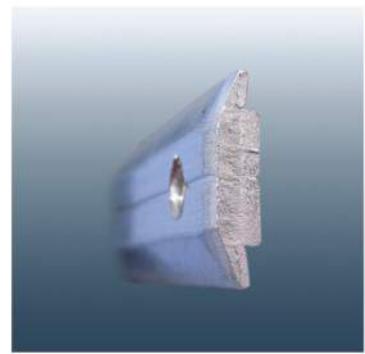

A-037

Installation (安装示意图)

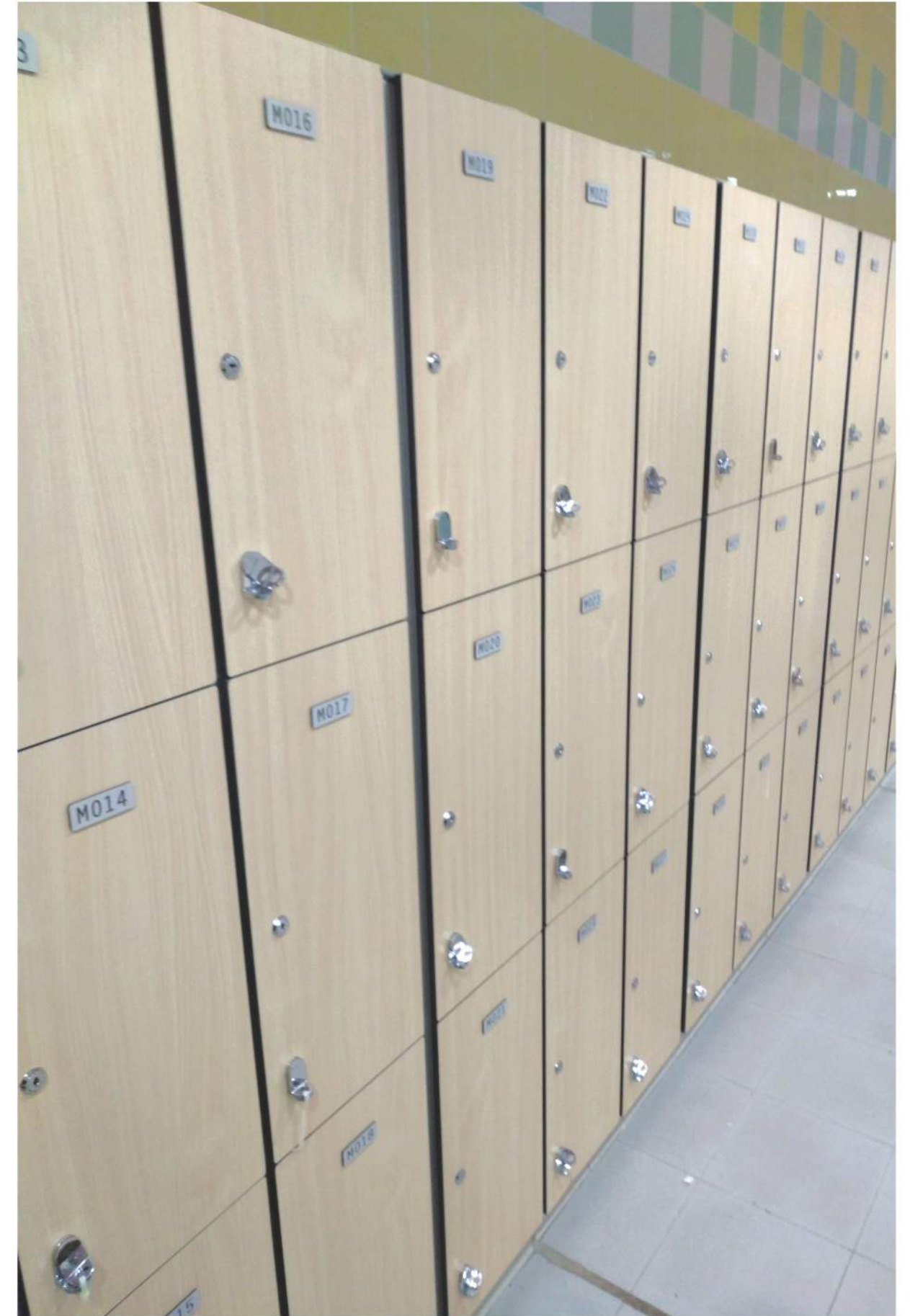
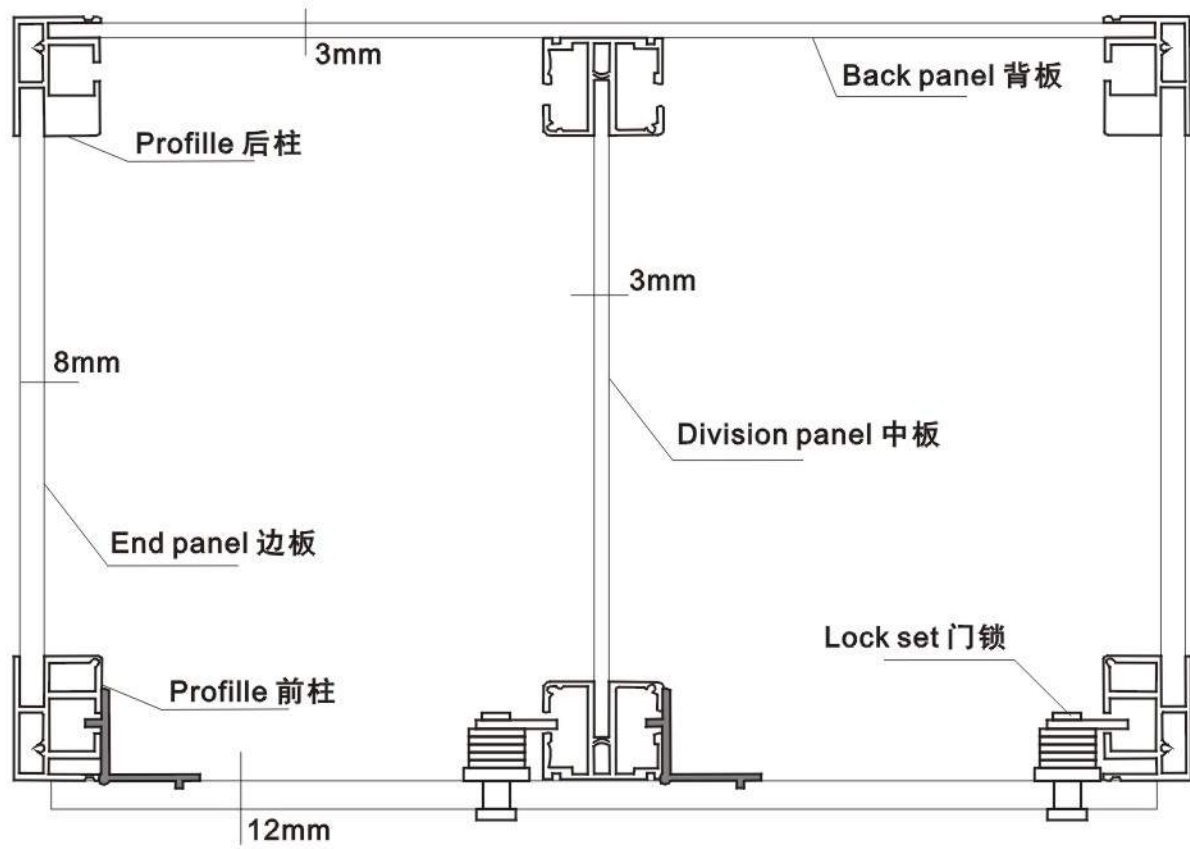



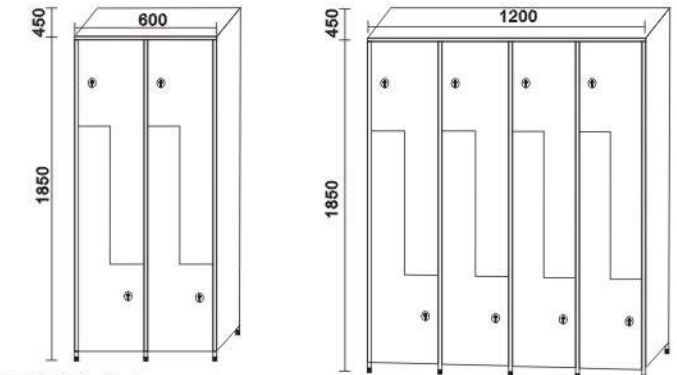

双门组合 2Tiers per column

柜内空间宽阔, 适合俱乐部、体育场等需容纳较大物品之场合使用。
2 Tiers per column are spacious, suitable for club, stadium and other occasions that requiring larger storage spaces.

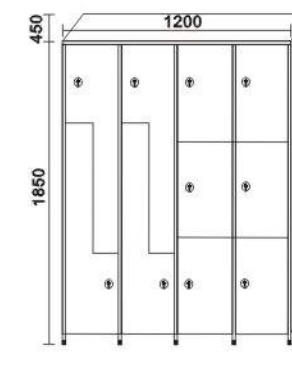

Z型双门组合 Z-shape

提供可挂衣的空间, 适合俱乐部、体育场等需悬挂衣服之场合使用。
Offer the space for clothes hanging, which are ideal for athletic clubs, gyms, and other locations that need to hang clothes.



**Z型双门与三门组合
Z-shape and 3 Tiers per column**

提供可挂衣的空间, 适合俱乐部、体育场等需悬挂衣服之场合使用。
Offer the space for clothes hanging, which are ideal for athletic clubs, gyms, and other locations that need to hang clothes.

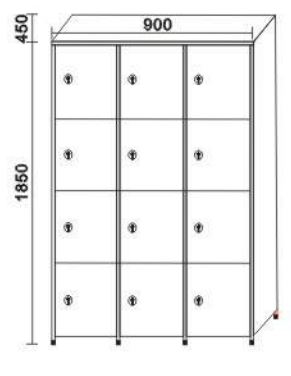

四门组合 4Tiers per column

适合放置固定尺寸的物品, 如书包、皮包等中型物品, 以学校、购物中心、车站等场所使用。
4 Tiers per column are suitable for schools, shopping malls, train stations, etc. Where need to place the fixed standard size items such as school bags, purses, etc.

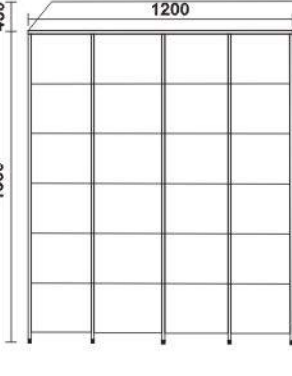

六门组合 6Tiers per column

以存放小型物品之特定场所使用, 例如溜冰场、保龄球场之寄鞋柜。
6 Tiers per column are ideal for locations requiring small storage space, such as skating rinks, bowling alleys, etc.

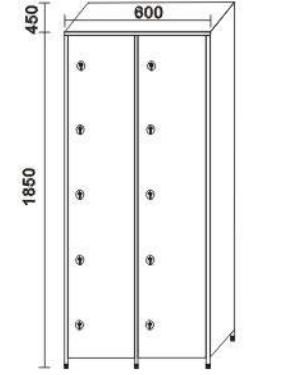

五门组合 5Tiers per column

以存放小型物品之特定场所使用, 例如溜冰场、保龄球场之寄鞋柜。
5 Tiers per column are ideal for locations requiring small storage space, such as skating rinks, bowling alleys, etc.

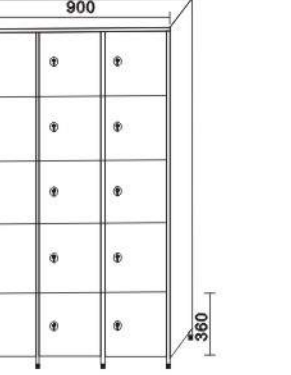
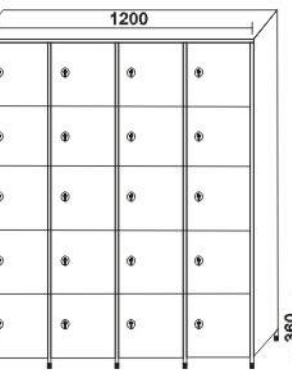





D

铝材系统
Aluminum System

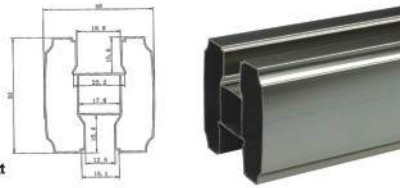
AK01
Specification:
12mm, 18mm
Length: 6m
Finishes:
SS color/black/matt
Packing: 8pcs



AK06
Specification:
12mm, 18mm
Length: 6m
Finishes:
SS color/black/matt
Packing: 20pcs

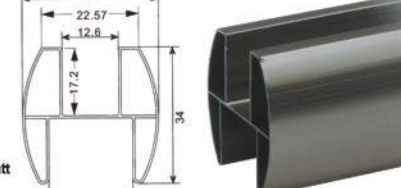

AK13
Specification:
18mm
Length: 6m
Finishes: SS color
Packing: 20pcs

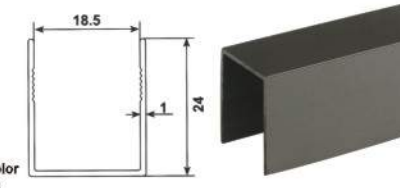

AK18
Specification:
12mm, 18mm
Length: 6m
Finishes: Satin nickle
Packing: 5pcs

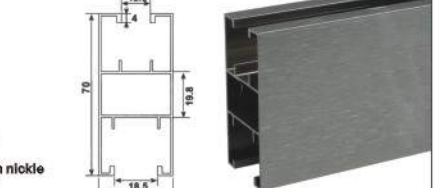

AK01A
Specification:
12mm, 18mm
Length: 6m
Finishes:
SS color/black/matt
Packing: 8pcs

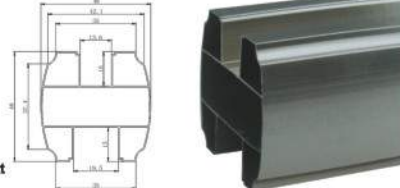

AK07
Specification:
18mm
Length: 6m
Finishes:
SS color/black/matt
Packing: 20pcs

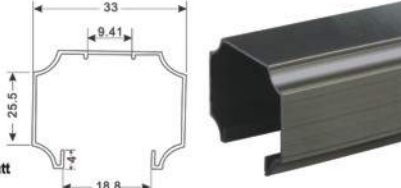

AK14
Specification: 12mm
Length: 6m
Finishes: SS color
Packing: 20pcs

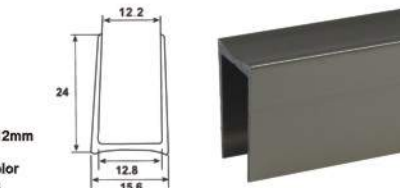

AK18A
Specification:
12mm, 18mm
Length: 6m
Finishes: Satin nickle
Packing: 5pcs

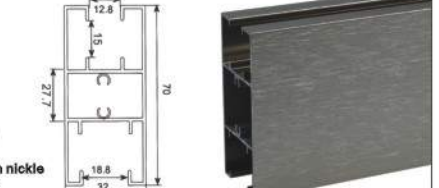

AK02
Specification:
12mm, 18mm
Length: 6m
Finishes:
SS color/black/matt
Packing: 10pcs

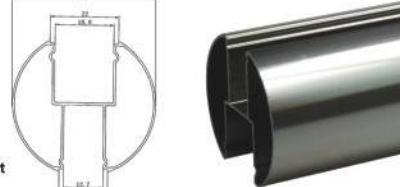

AK08
Specification:
12mm, 18mm
Length: 6m
Finishes:
SS color/black/matt
Packing: 20pcs

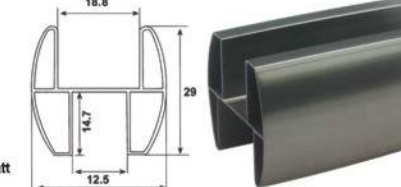

AK15
Specification: 18mm
Length: 4m, 6m
Finishes:
SS color/black/matt
Packing: 40pcs

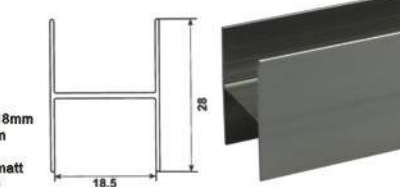

AK20
Specification: 12mm
Length: 3.7m, 4m
Finishes:
SS color/satin nickle
Packing: 80pcs

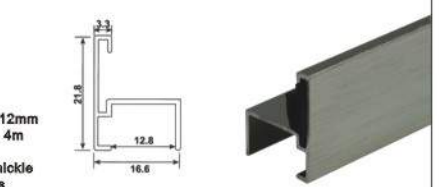

AK03A
Specification:
12mm, 18mm
Length: 6m
Finishes:
SS color/black/matt
Packing: 15pcs



AK09
Specification:
12mm, 18mm
Length: 6m
Finishes: SS color
Packing: 10pcs

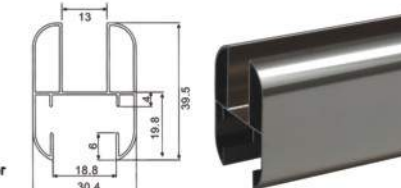

AK16
Specification: 12mm
Length: 4m, 6m
Finishes:
SS color/black/matt
Packing: 40pcs

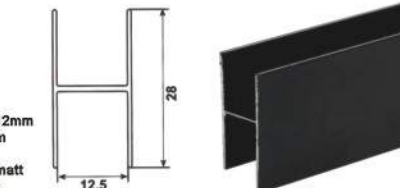

AK21
Specification: 18mm
Length: 3.7m, 4m
Finishes:
SS color/satin nickle
Packing: 80pcs

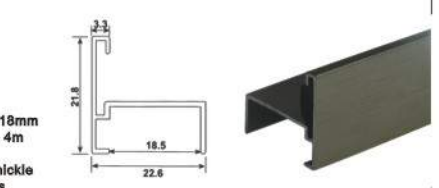

AK03B
Specification:
12mm, 18mm
Length: 6m
Finishes:
SS color/black/matt
Packing: 15pcs



AK10
Specification:
12mm, 18mm
Length: 6m
Finishes: Matt
Packing: 8pcs

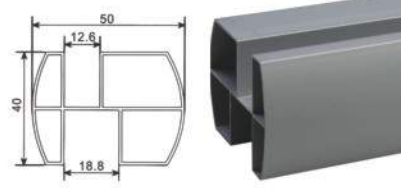

AK17
Specification:
12mm, 18mm
Length: 6m
Finishes: Satin nickle
Packing: 5pcs

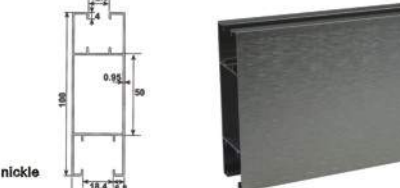

AK25
Specification:
18mm
Length: 3.7m, 4m
Finishes:
SS color/black
Packing: 80pcs

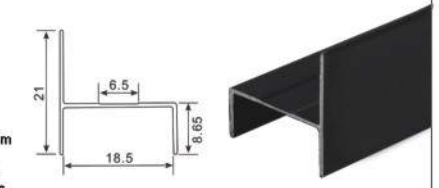

AK05
Specification:
12mm, 18mm
Length: 6m
Finishes:
Satin nickle
Packing: 6pcs



AK11
Specification:
12mm, 18mm
Length: 6m
Finishes:
Matt/satin nickle
Packing: 10pcs



AK17A
Specification:
12mm, 18mm
Length: 6m
Finishes: Satin nickle
Packing: 5pcs

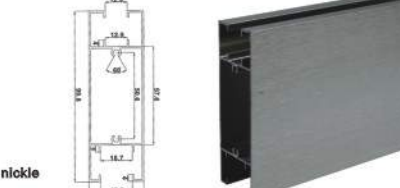

AK32
Specification:
12mm
Length: 3.7m, 4m
Finishes:
SS color/black
Packing: 80pcs

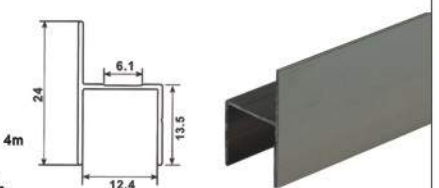

AK35
Specification:
18mm
Length: 3.7m, 4m
Finishes: SS color/black/matt
Packing: 80pcs

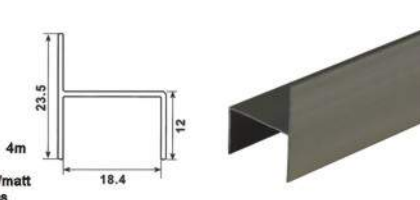

AK64
Specification:
12mm, 18mm
Length: 6m
Finishes: Satin nickle
Packing: 10pcs

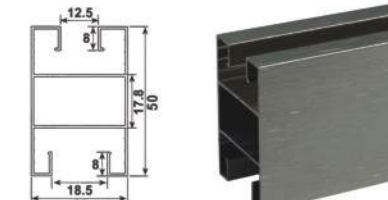

A-030
Specification:
12mm
Length: 1.85m
Finishes: Satin nickle/black
Packing: 20pcs

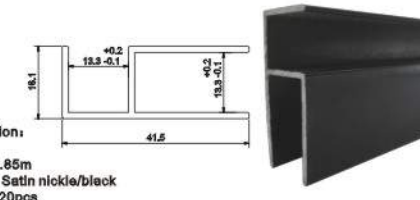

A-040
Specification:
19mm
Length: 1.85m
Finishes: Satin nickle/black
Packing: 20pcs

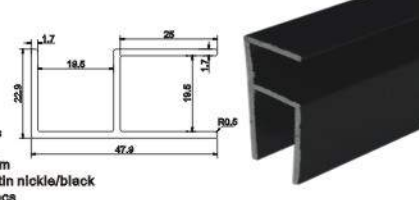

AK44
Specification:
18mm
Length: 4m
Finishes: SS color
Packing: 200pcs

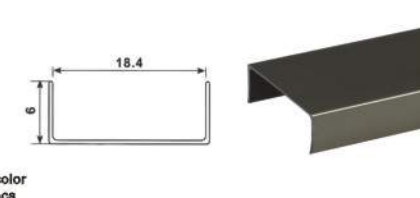

AK83
Specification:
Length:
Finishes:
Packing: 20pcs

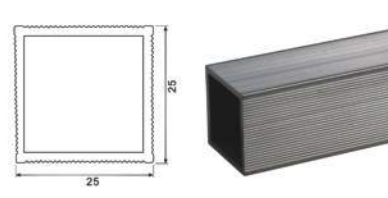

A-032
Specification:
3mm & 8mm
Length: 1.85m
Finishes: matt
Packing: 20pcs

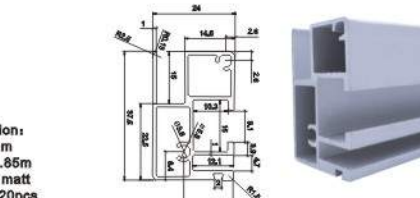

A-109
Specification:
3mm & 8mm
Length: 2m
Finishes: SS color/satin nickle
Packing: 6pcs

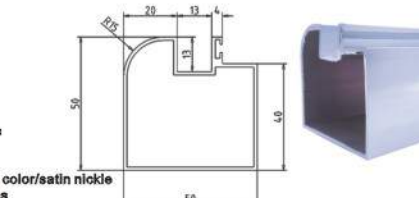

AK46
Specification:
12mm
Length: 4m
Finishes: SS color/black
Packing: 200pcs

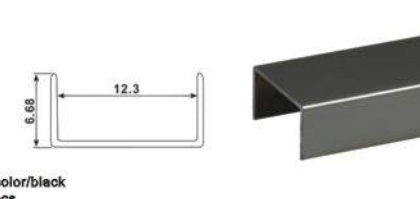

A-001
Specification:
12mm, 18mm
Length: 5.85m
Finishes: Satin nickle/black
Packing: 6pcs

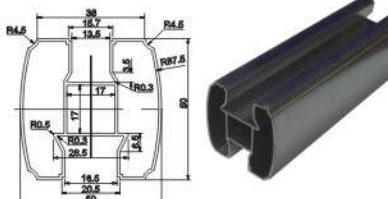

A-033
Specification:
3mm & 8mm
Length: 1.85m
Finishes: matt
Packing: 20pcs

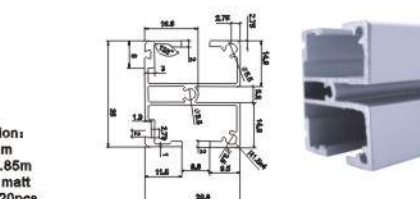

AK48
Specification:
12mm
Length: 6m
Finishes: SS color
Packing: 16pcs

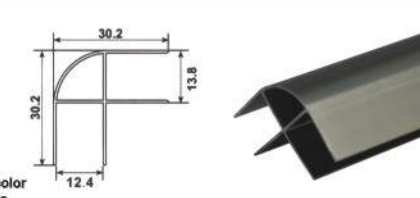

A-005
Specification:
13mm
Length: 1.85m
Finishes: SS color/black
Packing: 20pcs

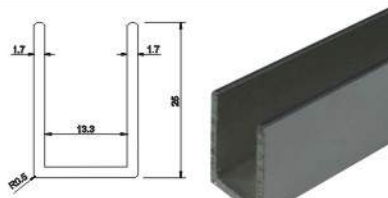

A-034
Specification:
3mm & 8mm
Length: 1.85m
Finishes: matt
Packing: 20pcs

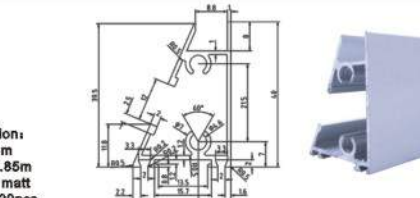

AK49
Specification:
18mm
Length: 6m
Finishes: SS color
Packing: 16pcs

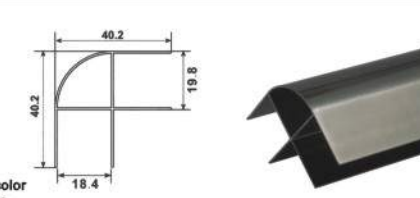

A-007
Specification:
12mm, 18mm
Length: 3m
Finishes: SS color/black/matt
Packing: 10pcs



A-035
Specification:
3mm & 8mm
Length: 1.85m
Finishes: matt
Packing: 20pcs

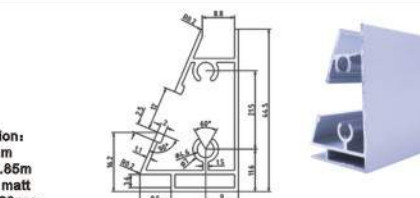

AK60
Specification:
12mm, 18mm
Length: 6m
Finishes: SS color
Packing: 10pcs

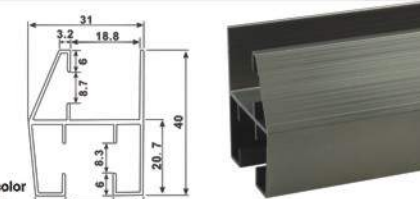

A-025
Specification:
13mm
Length: 5.85m
Finishes: Satin nickle/black
Packing: 6pcs

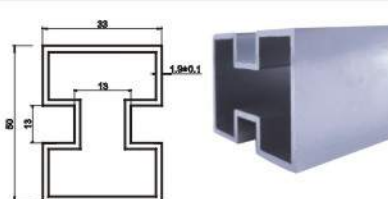

A-036
Specification:
3mm & 8mm
Length: 1.85m
Finishes: matt
Packing: 20pcs

