



**SPARE PARTS FOR  
COMMON RAIL SYSTEM (共轨系列)**

---

小配件，大作为，技艺精湛传百年

**PRODUCTS CATA 2019.06**



Web: [www.dgweiyuan.com](http://www.dgweiyuan.com)

E-mail: [webmaster@dgweiyuan.com](mailto:webmaster@dgweiyuan.com)

**COMPANY** from 1952...

Our company Donggang Weiyuan Fuel Injection Equipment Co., Ltd. is one of the most famous manufacturers of fuel injection equipment spare parts in China. The main products are auto plungers, nozzles, delivery valves, pencil nozzles, common rail parts, hydraulic heads of VE distributor pumps and other related products for imported automobiles, construction machinery and marine engines. Now we are devoting to developing a leading enterprise of fuel injection system in China.

### **PRODUCTIONS STRUCTURE**

Auto diesel engine fuel system plunger barrel, nozzle and delivery valve, which, including about 2000 kinds of model number. It mainly suit for diesel engine for EURO II Emission Standard.

High pressure fuel injector control Assembly. It called common rail spare parts too. The spare parts are mainly suit for diesel engine for EURO III Emission Standard.

Spare parts for marine diesel engines. Besides auto diesel engine parts, we also produce plunger, nozzle and delivery valve for marine diesel engines.

### **GENERAL SALES CONDITIONS**

#### **PRICE AND TRANSPORT**

The Payment currency can be USD or Euro, accessory charges excluded. Prices updates are indicated in the offer or at the time of the order confirmation. The transportation depends on the customers. And they will be shown on your confirmation and on the proforma invoice.



### **PAYMENT**

Payment terms are settled with the buyer at the time of the order confirmation. Payment cannot be suspended even in the events of claim. The goods remain goods until they have been paid for their entire value. Payment terms are indicated on your confirmation and on the invoice.

### **WARRANTY&CLAIMS**

Should there be any claims, as the supplier, we must be informed by written notice. Goods maybe returned only after our authorization is received. If the goods are tested broken on test bench, we can not guarantee you. If you use parts into cars, the warranty is invalid.

### **EXHIBITION INFORMATION**

Automechanika Istanbul  
Automechanika Frankfurt  
Canton Fair  
IRAN International Auto Parts Exhibition  
Automachinika Shanghai

### **CONTACTS**

**Tel: +86 024 88579578**

**Fax: +86 024 88579568**

**Address: Room B1606, fengtianyinzuo  
No19# youhao street, shenhe district  
Shenyang, Liaoning province, China**

**Email: [webmaster@dgweiyuan.com](mailto:webmaster@dgweiyuan.com)**

**Website: [www.dgweiyuan.com](http://www.dgweiyuan.com)**









**POST CODE: 110013**



# contents

## **Company Introduction**



## **Common Rail Parts**

- CR Nozzle 
- CR Injectors 
- Control Valves For Bo Injectors 
- Control Valves For Delph Injectors 
- EUP EUI Valve 
- Shaft For DENS&BO Injectors 
- SCV valve 
- Fuel Metering Valve Unit 
- Solenoid/Coil for injectors & pumps 





# contents

- Control Valves for DO injectors & pump 
- Imported Solenoid & Sensor Catalogue 
- Repair Tools 



# 东港威远油泵油嘴有限公司

ÖÜPÖ ÖœÖ Y ÖQYWœœ ØWòŠ œRòôVœP ÒÚWQÚT ÒP V ÖU.,ŠVÖ

## COMMON RAIL SERIES



7206-0379控制阀  
7206-0379 CONTROL VALVE



7206-0379控制阀II  
7206-0379 CONTROL VALVE



7206-0379控制阀III  
7206-0379 CONTROL VALVE



CAT01控制阀  
CAT01 CONTROL VALVE



7135-588控制阀  
7135-588 CONTROL VALVE



7135-486控制阀  
7135-486 CONTROL VALVE



7135-486支架  
7135-486 HOLDER



9308-621C/622B控制阀  
9308-621C/622B CONTROL VALVE(28239294/28239295)



9308-625C 控制阀  
9308-625C CONTROL VALVE  
( 28277576/28525582/28264094)



EUP / EUI 控制阀  
EUP/EUI CONTROL VALVE



HPO密封阀片  
HPO SEAL VALVE PLATE



BF15阀片  
BF15 CONTROL VALVE SPACER



334阀座  
334 VALVE SEAT



阀组件  
CONTROL VALVE ASSEMBLY



32F61-00062 阀组件  
32F61-00062 CONTROL VALVE ASSEMBLY



阀杆  
CONTROL VALVE ROD



HP3/HP4泵出油阀+紧帽  
HP3/HP4 PUMP OUTLET  
VALVE+ THREAD CAP



CP4泵出油阀  
CP4 PUMP OUTLET VALVE



M11油量阀  
M11 CONTROL VALVE



312-5620(HC)电磁阀  
312-5620(HC) SOLENOID



312-5620电磁阀  
312-5620 SOLENOID



380-0810电磁阀  
380-0810 SOLENOID



AEPD20电磁阀  
AEPD20 SOLENOID



177-4754电磁阀  
177-4754 SOLENOID



Y0046G电磁阀  
Y0046G SOLENOID



AEPD01电磁阀  
AEPD01 SOLENOID



0330001003 电磁阀  
0330001003 SOLENOID



095000-5450电磁阀  
095000-5450 SOLENOID



095000-5600电磁阀  
095000-5600 SOLENOID



FOORJ00395电磁阀  
FOORJ00395 SOLENOID



FOORC30318电磁阀  
FOORC30318 SOLENOID



FOORC30319 电磁阀  
FOORC30319 SOLENOID



FOORJ02703电磁阀  
FOORJ02703 SOLENOID





F00RJ02697电磁阀  
F00RJ02697 SOLENOID



55PP04-01传感器  
55PP04-01 COMMON RAIL  
SENSOR



55PP05-01传感器  
55PP05-01 COMMON RAIL  
SENSOR



55PP06-03传感器  
55PP06-03 COMMON RAIL  
SENSOR



55PP07-02传感器  
55PP07-02 COMMON RAIL  
SENSOR



55PP11-01传感器  
55PP11-01 COMMON RAIL  
SENSOR



55PP22-01传感器  
55PP22-01 COMMON RAIL  
SENSOR



55PP26-02传感器  
55PP26-02 COMMON RAIL  
SENSOR



55PP34-01传感器  
55PP34-01 COMMON RAIL  
SENSOR



5WS40209传感器  
5WS40209 COMMON RAIL  
SENSOR



6PH1001.1传感器  
6PH1001.1 COMMON  
RAIL SENSOR



6PH2001.2传感器  
6PH2001.2 COMMON  
RAIL SENSOR



43PP7-2传感器  
43PP7-2 COMMON  
RAIL SENSOR



45PP3-1传感器  
45PP3-1 COMMON  
RAIL SENSOR



45PP3-4传感器  
45PP3-4 COMMON  
RAIL SENSOR



55PP02-03传感器  
55PP02-03 COMMON  
RAIL SENSOR



55PP03-02传感器  
55PP03-02 COMMON  
RAIL SENSOR



85PP40-02传感器  
85PP40-02 COMMON  
RAIL SENSOR



499000-6131传感器  
499000-6131 COMMON  
RAIL SENSOR



499000-6080传感器  
499000-6080 COMMON  
RAIL SENSOR



499000-6160传感器  
499000-6160 COMMON  
RAIL SENSOR



499000-4441传感器  
499000-4441 COMMON  
RAIL SENSOR



937传感器  
937 COMMON RAIL  
SENSOR



161-1704-6传感器  
161-1704-6 COMMON RAIL  
SENSOR



157-3182传感器  
157-3182 COMMON RAIL  
SENSOR



23710-26011传感器  
23710-26011 COMMON  
RAIL SENSOR



1110010035限压阀  
1110010035 PRESSURE  
LIMITER



1110010017限压阀  
1110010017 PRESSURE-LIMITING VALVE



0954200281限压阀  
0954200281 PRESSURE LIMITER



SCV阀  
SUCTION CONTROL VALVE



0281002241燃油压力调节阀  
0281002241 PRESSURE REGULATOR



928400617计量单元  
928400617 MATERING UNIT



共轨油嘴  
COMMON RAIL NOZZLE



共轨油嘴  
COMMON RAIL NOZZLE



共轨油嘴  
COMMON RAIL NOZZLE



共轨油嘴  
COMMON RAIL NOZZLE



7200-0053 & 7200-0054 O型圈  
7200-0053 & 7200-0054  
O-RINGS



C13修理包  
C13/C15 REPAIR KIT



修理包  
REPAIR KIT



压电喷油器修理包  
REPAIR KITS FOR  
PIEZOELECTRIC FUEL  
INJECTOR



德尔福喷油器修理包  
REPAIR KITS FOR  
DELPHI FUEL  
INJECTOR



C7泵拆装半圆卡板C7  
SNAP-GAUGE



C7/C9泵拆装卡板  
SNAP-GAUGE FOR C7 / C9  
PUMP



多功能扳手  
MULTI-FUNCTION WRENCH



C7油嘴紧帽拆装工具  
NOZZLE NUT ASSEMBLING  
AND DISASSEMBLING TOOL



V2油嘴适配器  
V2 NOZZLE TESTING  
TOOL



V4油嘴适配器  
V4 NOZZLE TESTING  
TOOL



胶圈拆卸工具  
DISASSEMBLING TOOL  
FOR O-RING



卡特喷油器拆卸工具  
ASSAMBLING  
AND DISSAMBLING  
TOOL FOR CAT  
Injector



电装喷油器拆卸工具  
ASSAMBLING AND  
DISSAMBLING  
TOOL FOR DENSO  
Injector



压电喷油器拆卸工具  
ASSAMBLING AND  
DISSAMBLING  
TOOL FOR  
PIEZOELECTRICITY  
Injector



滤芯拆装工具  
FILTER ELEMENT  
REMOVAL TOOL



C7/C9 3126D 拆装工具  
C7/C9 3126D  
WITHDRAWAL TOOL



共轨拆装工具 ( 22件套 )  
SIMPLE COMMON RAIL  
TOOLS(22pcs)



387-9427喷油器  
387-9427 INJECTOR



328-2574喷油器  
328-2574 INJECTOR



236-0962喷油器  
236-0962 INJECTOR



32F61-00062 喷油器(国产)  
32F61-00062  
INJECTOR



32F61-00062 翻新喷油器  
32F61-00062  
Renewed INJECTOR



326-4756喷油器  
326-4756 INJECTOR



32F61-00062 喷油器  
32F61-00062  
INJECTOR



188-1320喷油器  
188-1320 INJECTOR



127-8222喷油器  
127-8222 INJECTOR



www.dgweiyuan.com

# C7C9泵 C7C9 PUMP



www.dgweiyuan.com

C7输油泵轴  
C7 OIL PUMP SPINDLE



www.dgweiyuan.com

C7促动泵轴  
PUMP MAIN SPINDLE



www.dgweiyuan.com

C7/C9泵大轴承  
BIG BEARING



www.dgweiyuan.com

C7/C9泵小轴承  
SMALL BEARING



www.dgweiyuan.com

C7/C9泵拨叉  
SHIFTING FORK FOR C7/  
C9 PUMP



www.dgweiyuan.com

C7/C9泵芯  
C7/C9 PUMP PLUNGER



www.dgweiyuan.com

C7/C9泵后盖  
C7/C9 PUMP  
REAR COVER



www.dgweiyuan.com

C7电磁阀  
C7 SOLENOID



www.dgweiyuan.com

C7泵震荡板  
Shock board



www.dgweiyuan.com

C7提升阀  
C7 POPPET VALVE



www.dgweiyuan.com

C7/C9泵修理包  
REPAIR KITS FOR  
C7/C9 PUMP



www.dgweiyuan.com

C7/C9输油泵  
C7/C9 FULE DELIVERY  
PUMP





C7输油泵小齿轮  
C7 SMALL GEAR



C7促动泵泄压阀  
PRESSURE RELIEF  
VALVE FOR C7 PUMP



C7泵单向阀 ( M10 )  
NON-RETURN VALVE  
FOR C7 PUMP



C7泵柱塞弹簧  
C7 Pump Plunger Spring



7孔垫片  
7 HOLES PLATE



C7/C10泵六角螺丝  
C7/C10 HEXAGON SCREW

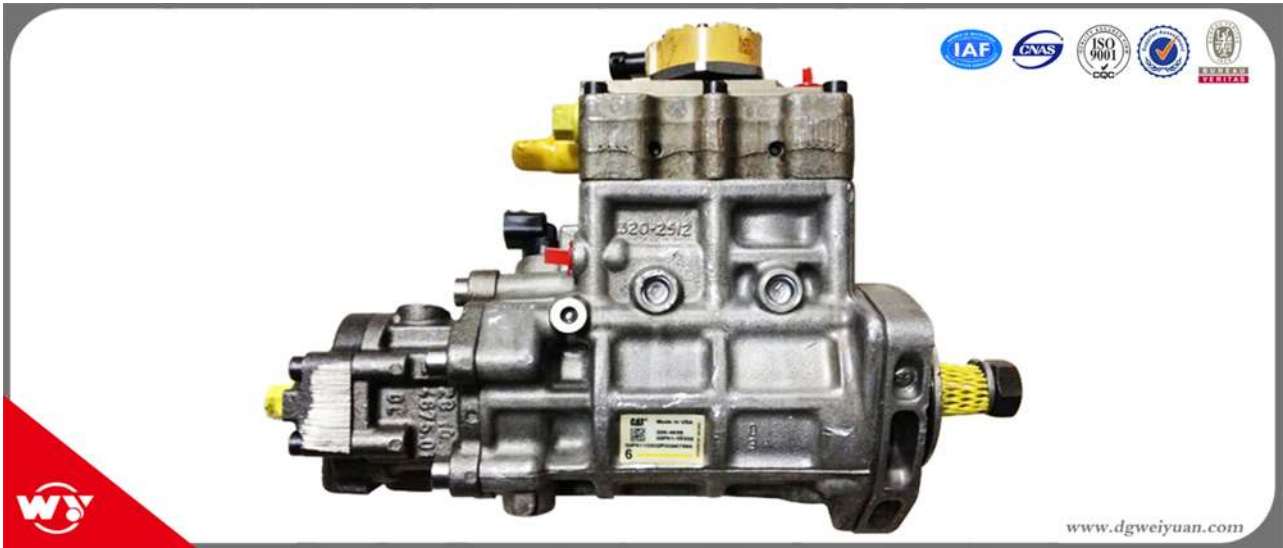

www.dgweiyuan.com

## 320D泵 320DPUMP



320D泵柱塞  
320D PUMP PLUNGER  
( 7.995~8.005mm )



238-0120传感器  
238-0120 COMMON RAIL  
SENSOR



312-5620电磁阀  
312-5620 SOLENOID



320D泵出油阀  
320D PUMP OUTLET  
VALVE



320D输油泵  
320D FULE DELIVERY  
PUMP



320D泵电磁阀总成  
SOLENOID COMPLETE  
FOR 320D PUMP



## C7C9喷油器 C7C9 INJECTOR



C7/C9滑阀  
C7/C9 SPOOL VALVE  
(OIL PRESSURE BOOST  
VALVE)



C7/C9滑阀垫片  
C7/C9 SPOOL VALVE  
SPACER



C7/C9 中间板  
C7/C9 MIDDLE PLATE  
(DIESEL CONTROL VALVE)



C7/C9控制阀  
C7/C9 CONTROL VALVE



C7/C9间隔块  
C7/C9 SPACER PLATE



C7电磁阀  
C7 SOLENOID



C7油嘴组件  
C7 NOZZLE ASSEMBLY



C7/C9油嘴紧帽  
C7/C9 NOZZLE CAP NUT



C7螺钉和定位销  
C7 SCREWS AND  
DOWELS



C7/C9/C-9喷油器修理包  
C7/C9/C-9 REPAIR KITS



C7喷油器定位销  
φ1.6X19  
C7 DOWELS φ1.6X19



C7喷油器弹簧  
C7 INJECTOR  
SPRING



www.dgweiyuan.com

## C-9喷油器 C-9 INJECTOR



www.dgweiyuan.com

C-9控制阀  
C-9 CONTROL VALVE



www.dgweiyuan.com

C-9滑阀  
C-9 SPOOL VALVE  
(OIL PRESSURE BOOST  
VALVE)



www.dgweiyuan.com

C-9中间板  
C-9 MIDDLE PLATE  
(DIESEL CONTROL VALVE)



www.dgweiyuan.com

C-9垫片  
C-9 SPACER



www.dgweiyuan.com

C9油嘴组件  
C9 NOZZLE ASSEMBLY



www.dgweiyuan.com

C9油嘴组件  
C9 NOZZLE ASSEMBLY

# CATERPILLAR C7 HEUI

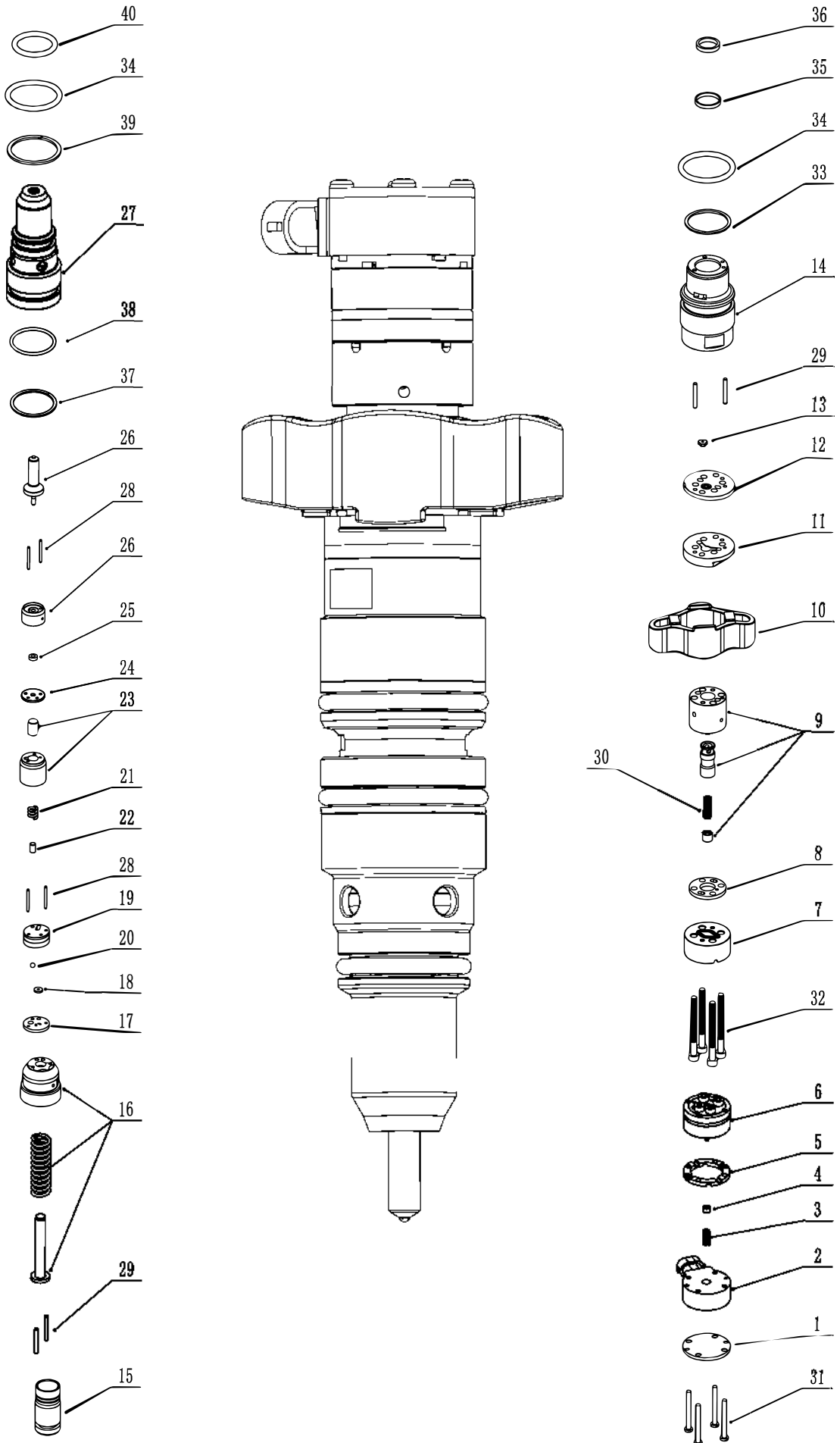

# CATERPILLAR C7 HEUI

No.	CO. NO	DESCRIPTION	Q. TY	REMARKS
1	OCA638218001	solenoid cover	1	
2	OCA638218002	solenoid	1	
3	OCA638218003	spring	1	
4	OCA638218004	spacer shim	1	
5	OCA638218005	solenoid spacer	1	
6	OCA638218006	control valve	1	
7	OCA638218007	spacer plate	1	
8	OCA638218008	spool valve spacer	1	
9	OCA638218009	spool valve	1	
10	OCA638218010	connecting flange	1	
11	OCA638218011	transfer slab	1	
12	OCA638218012	throttle plate	1	
13	OCA638218013	check plate	1	
14	OCA638218014	injector body	1	
15	OCA638218015	piston	1	
16	OCA638218016	plunger and barrel assembly	1	
17	OCA638218017	valve block	1	
18	OCA638218018	check plate	1	
19	OCA638218019	valve plate	1	
20	OCA638218020	steel ball	1	
21	OCA638218021	spring	1	
22	OCA638218022	limited block	1	
23	OCA638218024	middle plate	1	
24	OCA638218027	nozzle gasket	1	
25	OCA638218026	gasket	1	
26	OCA638218025	nozzle assembly	1	
27	OCA638218028	nozzle cap nut	1	
28	OCA638218029	positioning pin	4	
29	OCA638218036	positioning pin	4	
30	OCA638218009 02 02	spring	1	
31	OCA638218038	screw	4	
32	OCA638218037	screw	4	
33	OCA638218035	gasket ring	1	
34	OCA638218034	O-ring	2	
35	OCA638218015-02	gasket	1	
36		gasket	1	
37	OCA638218033	gasket ring	1	
38	OCA638218031	O-ring	1	
39	OCA638218032	gasket ring	1	
40	OCA638218030	O-ring	1	



236# Central Street GuShan Town,DongGang ,LiaoNing Province,118113,China



RoomB1606 Feng Tian Yin Zuo, 19# You Hao Street, ShenHe District, Shenyang City, Liaoning Province, China, 110013



18-59#,Puwen Road,ShenBeiXin District ShenYang,LiaoNing,110122,China



[www.dgweiyuan.com](http://www.dgweiyuan.com)



[webmaster@dgweiyuan.com](mailto:webmaster@dgweiyuan.com)



0086-24-88579578 Fax:0086-24-88579568



AliExpress



AliExpress



阿里巴巴  
Alibaba.com



阿里巴巴  
Alibaba.com



Company WEB

东港威远油泵油嘴有限公司

DONG GANG WEIYUAN FUEL  
INJECTION EQUIPMENT CO., L.T.D.



共轨油嘴目录

COMMON RAIL NOZZLE

Website:[www.dgweiyuan.com](http://www.dgweiyuan.com)

Email:[webmaster@dgweiyuan.com](mailto:webmaster@dgweiyuan.com)

Tel:0086-24-88579578

Fax:0086-24-88579568





# 共轨油嘴目录

## COMMON RAIL NOZZLE CATALOGUE

序号	参考编号	公司编号	适用的喷油器	备注
NO.	REFERENCE NO.	CO. NO	SUIT TO INJECTOR	REMARK
1	DSLA143P1523	00925-1523	0 445 120 060	
2	DSLA143P970	00925-P970	0 445 120 007	
3	DSLA128P1510	00925-1510	0 455 120 059	
4	DSLA136P804	00925-P804	0 445 120 002	
5	DSLA140P1723	00925-1723	0 445 120 123	
6	DLLA155P1674	00925-1674	0 445 110 291	
7	DLLA153P1721	00925-1721	0 445 120 106	
8	DLLA152P1690	00925-1690	0 445 120 083	
9	DLLA152P1768	00925-1768	0 445 120 149/169	
10	DLLA152P1819	00925-1819	0 445 120 170	
11	DLLA152P2142	00925-2142	0 445 120 183	
12	DLLA151P1656	00925-1656	0 445 120 081	
13	DLLA150P1622	00925-1622	0 445 120 078	
14	DLLA150P1683	00925-1683	0 445 110 304	
15	DLLA150P1712	00925-1712	0 445 120 117	
16	DLLA150P1772	00925-1772	0 445 110 332	
17	DLLA150P1781	00925-1781	0 445 120 150	
18	DLLA150P1803	00925-1803	0 445 110 333	
19	DLLA150P1808	00925-1808	0 445 110 343	
20	DLLA149P1724	00925-1724	0 445 120 130	
21	DLLA149P1813	00925-1813	0 445 110 334	
22	DLLA148P1671	00925-1671	0 445 120 102	
23	DLLA148P1688	00925-1688	0 445 120 110	
24	DLLA148P1809	00925-1809	0 445 110 345	
25	DLLA148P1815	00925-1815	0 445 120 158/156	
26	DLLA146P1725	00925-1725	0 445 120 129	
27	DLLA147P1702	00925-1702	0 445 110 313	
28	DLLA145P978	00925-P978	0 445 110 059	
29	DLLA138P1533	00925-1533	0 445 110 248	
30	DLLA142P1654	00925-1654	0 445 120 087	
31	DLLA142P1709	00925-1709	0 445 120 121	
32	DLLA143P1696	00925-1696	0 445 120 127	
33	DLLA144P1707	00925-1707	0 445 120 122	



# 共轨油嘴目录

## COMMON RAIL NOZZLE CATALOGUE

序号	参考编号	公司编号	适用的喷油器	备注
NO.	REFERENCE NO.	CO. NO	SUIT TO INJECTOR	REMARK
34	DLLA145P1655	00925-1655	0 445 120 086	
35	DLLA145P1738	00925-1738	0 445 110 321	
36	DLLA146P1398	00925-1398		
37	DLLA146P1527	00925-1527		
38	DLLA146P1530	00925-1530		
39	DLLA143P1535	00925-1535	0 445 120 057	
40	DLLA150PV3206491	00925-6491		
41	DLLA155P1090	00925-1090		
42	DLLA182P1773	00925-1773		
43	DLLA118P1357	00925-1357		
44	DLLA118P1697	00925-1697	0 445 120 125	
45	DLLA118P2203	00925-2203		
46	DLLA128P1510	00925-1510		
47	DLLA135P1747	00925-1747		
48	DLLA137P1577	00925-1577		
49	DLLA141P2146	00925-2146		
50	DLLA142P2262	00925-2262		
51	DLLA143P2143	00925-2143		
52	DLLA143P2155	00925-2155		
53	DLLA143P2365	00925-2365		
54	DLLA144P1050	00925-1050		
55	DLLA144P1539	00925-1539		
56	DLLA144P1565	00925-1565		
57	DLLA144P2273	00925-2273		
58	DLLA145P1720	00925-1720		
59	DLLA145P1794	00925-1794		
60	DLLA145P2168	00925-2168		
61	DLLA145P2270	00925-2270		
62	DLLA145P2397	00925-2397		
63	DLLA140P1296+	00925-1296	0 445 110 141	
64	DLLA146P1305	00925-1305		
65	DLLA146P1339	00925-1339	0 445 120 030/218	
66	DLLA146P1405	00925-1405		



# 共轨油嘴目录

## COMMON RAIL NOZZLE CATALOGUE

序号	参考编号	公司编号	适用的喷油器	备注
NO.	REFERENCE NO.	CO. NO	SUIT TO INJECTOR	REMARK
67	DLLA146P1406	00925-1406	0 445 120 041	
68	DLLA146P1581	00925-1581		
69	DLLA146P1770	00925-1770		
70	DLLA147P2405	00925-2405		
71	DLLA148P1229	00925-1229		
72	DLLA148P1524	00925-1524	0 445 120 061/128/217	
73	DLLA148P1761	00925-1761		
74	DLLA148P2129	00925-2129		
75	DLLA148P2221	00925-2221		
76	DLLA148P2222	00925-2222		
77	DLLA148P2369	00925-2369		
78	DLLA149P1471	00925-1471	0 445 110 239/311	
79	DLLA149P1562	00925-1562		
80	DLLA149P2166	00925-2166		
81	DLLA150P1008	00925-1008		
82	DLLA150P1011	00925-1011	0 445 110 101/064	
83	DLLA150P1151	00925-1151		
84	DLLA150P1197	00925-1197	0 445 110 126/290	
85	DLLA150P1298	00925-1298		
86	DLLA150P1511	00925-1511	0 445 110 257	
87	DLLA150P1512	00925-1512	0 445 110 253/254	
88	DLLA150P1564	00925-1564		
89	DLLA150P1566	00925-1566	0 445 120 074/138/139	
90	DLLA150P1606	00925-1606	0 445 110 269/270	
91	DLLA150P1666	00925-1666		
92	DLLA150P1695	00925-1695		
93	DLLA150P1826	00925-1826		
94	DLLA150P1827	00925-1827		
95	DLLA150P1828	00925-1828	0 445 120 163	
96	DLLA150P2121	00925-2121		
97	DLLA150P2123	00925-2123		
98	DLLA150P2125	00925-2125		
99	DLLA150P2142	00925-2142		



# 共轨油嘴目录

## COMMON RAIL NOZZLE CATALOGUE

序号	参考编号	公司编号	适用的喷油器	备注
NO.	REFERENCE NO.	CO. NO	SUIT TO INJECTOR	REMARK
100	DLLA150P2143	00925-2143		
101	DLLA150P2197	00925-2197		
102	DLLA150P2219	00925-2219		
103	DLLA150P2259	00925-2259		
104	DLLA150P2299	00925-2299		
105	DLLA150P2386	00925-2386		
106	DLLA150PV3	00925-0PV3		
107	DLLA151P2182	00925-2182		
108	DLLA151P2240	00925-2240		
109	DLLA152P1681	00925-1681		
110	DLLA152P2344	00925-2344		
111	DLLA152P2422	00925-2422		
112	DLLA153P1270+	00925-1270	0 445 110 155/156/176/177/193/194	
113	DLLA153P1608	00925-1608	0 445 110 274/275	
114	DLLA153P1609	00925-1609		
115	DLLA153P1720	00925-1720		
116	DLLA153P2189	00925-2189		
117	DLLA153P2210	00925-2210		
118	DLLA154P1418	00925-1418		
119	DLLA154P988	00925-P988		
120	DLLA154PN270	00925-N270		
121	DLLA155P1493	00925-1493	0 445 110 250	
122	DLLA155P1495	00925-1495		
123	DLLA155P822	00925-P822		
124	DSLA156P1107	00925-1107	0 445 110 095/096/120/121/201/202/205/206	
125	DLLA156P1114	00925-1114	0 445 110 091/092/306	
126	DLLA156P1367	00925-1367		
127	DLLA156P1368	00925-1368	0 445 110 186/279	
128	DLLA156P1473	00925-1473		
129	DLLA156P1509	00925-1509	0 445 110 255/256	
130	DLLA156P1608	00925-1608		
131	DLLA182P1668	00925-1668		



# 共轨油嘴目录

## COMMON RAIL NOZZLE CATALOGUE

序号	参考编号	公司编号	适用的喷油器	备注
NO.	REFERENCE NO.	CO. NO	SUIT TO INJECTOR	REMARK
132	DLLA82P1773	00925-1773		
133	DLLAP152P805	00925-P805		
134	DSLA140P862+	00925-P862	0 445 110 021/146	
135	DSLA142P795	00925-P795	0 445 110 044/020/008	
136	DSLA143P1058	00925-1058	0 445 120 018	
137	DSLA143P5501	00925-5501	0 445 120 212	
138	DSLA145P1115+	00925-1115	0 445 110 102	
139	DSLA150P1043	00925-1043	0 414 720 013/028/039	
140	DSLA150P1426	00925-1426		
141	DSLA156P1079/+	00925-1079	0 445 110 054/055	
142	DSLA154P1034	00925-1034	0 445 110 070/069/035	
143	DSLA154P1320	00925-1320	0 445 110 106/107/108/170/171/181/182/189/190	
144	DSLA156P736	00925-P736	0 445 110 003/004/009/010/011/012/024/025/071/072	
145	DSLA158P974+	00925-P974	0 445 120 008	
146	DSLA150P1076	00925-1076	0 445 120 084/020/019	
147	DSLA156P737	00925-P737	0 445 110 005/006/014/015	
148	DSLA145P763	00925-P763	0 445 110 002	
149	DSLA150P783	00925-P783	0 414 720 015/035/007	
150	DSLA150P847	00925-P847	0 414 701 008	
151	DSLA150P848	00925-P848	0 414 701 007/020/044	
152	DSLA144P869	00925-P869	0 445 110 019	
153	DSLA155P872	00925-P872	0 414 702 002/003/005	
154	DLLA156P889	00925-P889	0 445 110 034/035	
155	DSLA144P890	00925-P890	0 445 110 036	
156	DLLA145P926	00925-P926	0 445 110 047/266	
157	DLLA145P928	00925-P928	0 445 110 037/041/049	
158	DSLA144P971	00925-P971	0 445 110 057	
159	DSLA144P973	00925-P973	0 445 110 019	
160	DSLA145P979	00925-P979	0 445 110 063	
161	DSLA142P988	00925-P988	0 445 110 062	
162	DSLA144P1021	00925-1021	0 445 110 068	



# 共轨油嘴目录

## COMMON RAIL NOZZLE CATALOGUE

序号	参考编号	公司编号	适用的喷油器	备注
NO.	REFERENCE NO.	CO. NO	SUIT TO INJECTOR	REMARK
163	DSLA140P1033	00925-1033	0 445 110 011	
164	DSLA146P1055	00925-1055	0 445 110 075	
165	DSLA140P1061	00925-1061	0 445 110 077/078	
166	DLLA160P1063	00925-1063	0 445 110 080/122/131	
167	DLLA148P1067	00925-1067	0 445 110 081/231/366	
168	DSLA145P1091	00925-1091	0 445 110 087	
169	DLLA156P1111	00925-1111	0 445 110 097/098/103/104/203/204/207/208	
170	DSLA156P1113+	00925-1113	0 445 110 100/099	
171	DSLA154P1129	00925-1129	0 445 110 106/107/108	
172	DSLA140P1142	00925-1142	0 445 110 110	
173	DSLA156P1155+	00925-1155	0 445 110 115	
174	DSLA148P1213	00925-1213	0 445 110 019	
175	DLLA148P1221	00925-1221	0 445 110 111	
176	DSLA150P1224	00925-1224	0 445 110 083	
177	DLLA153P1246++	00925-1246	0 445 110 137/138/162/163/191/192	
178	DSLA150P1247	00925-1247	0 414 720 215/208/213	
179	DSLA150P1248	00925-1248	0 414 720 214/216/131	
180	DSLA156P1265+	00925-1265	0 445 110 151/152/224/225	
181	DSLA144P1295	00925-1295	0 445 110 119	
182	DLLA160P1308	00925-1308	0 445 110 164/216	
183	DLLA142P1321+	00925-1321	0 445 110 165/244	
184	DLLA142P1333	00925-1333		
185	DLLA148P1347	00925-1347	0 445 110 159/243/391	
186	DLLA142P1363	00925-1363	0 445 110 187	
187	DLLA150P1373	00925-1373	0 445 110 136-188	
188	DLLA140P1377	00925-1377	0 445 120 036	
189	DSLA158P1385	00925-1385	0 445 120 027	
190	DLLA143P1404	00925-1404	0 445 120 043	
191	DLLA148P1407	00925-1407	0 445 110 213	
192	DLLA150P1437	00925-1437	0 445 110 183//316/381	
193	DSLA142P1474	00925-1474	0 445 110 076	



# 共轨油嘴目录

## COMMON RAIL NOZZLE CATALOGUE

序号	参考编号	公司编号	适用的喷油器	备注
NO.	REFERENCE NO.	CO. NO	SUIT TO INJECTOR	REMARK
194	DLLA153P1494	00925-1494	0 445 110 237/238	
195	DLLA155P1514	00925-1512	0 445 110 249	
196	DLLA149P1515	00925-1515	0 445 110 259	
197	DLLA152P1525	00925-1525	0 445 110 260	
198	DLLA143P1536	00925-1536	0 445 120 054	
199	DLLA146P1545	00925-1545	0 445 120 050/185	
200	DLLA152P1563	00925-1545	0 445 120 062	
201	DLLA142P1595	00925-1595	0 445 110 273	
202	DLLA142P1607	00925-1607	0 445 110 276	
203	DLLA143P1619	00925-1619	0 445 120 089	
204	DLLA148P1623	00925-1623	0 445 110 284	
205	DLLA148P1641++	00925-1641	0 445 120 100/154/219	
206	DSLA124P1659	00925-1659	0 445 120 032/103/1140	
207	DLLA148P1660	00925-1660	0 445 110 299/308/327	
208	DLLA152P1661+	00925-1661	0 445 110 300	
209	DLLA118P1691	00925-1691	0 445 120 120	
210	DLLA150P1734	00925-1734	0 445 110 322/351	
211	DLLA126P1776	00925-1776	0 445 120 140	
212	DLLA150P2118	00925-2118		
213	DLLA150P2220	00925-2220	0 445 110 413	
214	DLLA139P2229	00925-2229	0 445 110 418/520	
215	DLLA143P2248	00925-2248		
216	DSLA143P5499	00925-5499	0 445 120 210	
217	DSLA124P5500	00925-5500	0 445 120 208	
218	DSLA128P5510	00925-5510	0 445 120 231	
219	DSLA124P5516	00925-5516	0 445 120 238	
220	DSLA143P5519	00925-5519	0 445 120 255	
221	DSLA143P5540	00925-5540	0 445 120 273	
222	DSLA150P442	00925-P442		2437010076
223	DSLA155P572	00925-P572		0433171433
224	DSLA150P706	00925-P706		2437010059



# 共轨油嘴目录

## COMMON RAIL NOZZLE CATALOGUE

序号	参考编号	公司编号	适用的喷油器	备注
NO.	REFERENCE NO.	CO. NO	SUIT TO INJECTOR	REMARK
1	DLLA152P865	00926-P865	5511	
2	DLLA153P977	00926-P977	6691	
3	DLLA153P884	00926-P884	5801	
4	DLLA157P855	00926-P855	5450	
5	DLLA158P1096	00926-1096	8901	DLLA158P984
6	DLLA158P834	00926-P834	5226/5224	
7	DLLA158P844	00926-P844	6363/5342/6364	
8	DLLA155P964	00926-P964	6790/6791	DLLA155P1090
9	DLLA155P965	00926-P965	6700/8010	
10	DLLA155P842	00926-P842	6591/6593	
11	DLLA155P848	00926-P848	6353	
12	DLLA150P927	00926-P927	6222/5940	
13	DLLA150P951	00926-P951	6221	
14	DLLA150P965	00926-P965	5511	
15	DLLA150P835	00926-P835	5212/5214	
16	DLLA150P848	00926-P848	8350/8353	
17	DLLA150P907	00926-P907	5951	
18	DLLA149P786	00926-P786	0761	
19	DLLA150P1052	00926-1052	8100	
20	DLLA147P854	00926-P854	5471	
21	DLLA145P864	00926-P864	5930/5931/619X/552X	
22	DLLA145P870	00926-P870	5600	
23	DLLA155P970	00926-P970	978X/973X	
24	DLLA138P920	00926-P920	6140 07L0127	
25	DLLA142P852	00926-P852	1211/1210	
26	DLLA145P1049	00926-1049	8010	
27	ALLA150P866	00926-P866	555X	
28	DLLA125P889	00926-P889		
29	DLLA127P944	00926-P944		
30	DLLA129P890	00926-P890		
31	DLLA133P814	00926-P814		
32	DLLA133P888	00926-P888		
33	DLLA138P919	00926-P919		





共轨油嘴目录  
COMMON RAIL NOZZLE CATALOGUE

序号	参考编号	公司编号	适用的喷油器	备注
NO.	REFERENCE NO.	CO. NO	SUIT TO INJECTOR	REMARK
34	DLLA138P934	00926-P934		
35	DLLA139P851	00926-P851		
36	DLLA139P887	00926-P887	649X	
37	DLLA139P925	00926-P925		
38	DLLA143P761	00926-P761	056X	
39	DLLA148P763	00926-P763	054X	
40	DLLA144P830	00926-P830		
41	DLLA145P1024	00926-1024	776X	
42	DLLA145P1031	00926-1031		
43	DLLA145P875	00926-P875	576X	
44	DLLA147P538	00926-P538		
45	DLLA147P747	00926-P747	057X 042X	
46	DLLA147P762	00926-P762		
47	DLLA147P788	00926-P788	094X 077X	
48	DLLA148P765	00926-P765	051X	
49	DLLA148P820	00926-P820	5160	
50	DLLA148P821	00926-P821		
51	DLLA148P826	00926-P826		
52	DLLA148P872	00926-P872	565X	
53	DLLA148P915	00926-P915	607X	
54	DLLA148P997	00926-P997		
55	DLLA150P1023	00926-1023	758X	
56	DLLA155P1025	00926-1025	778X/773X	
57	DLLA150P794	00926-P794		
58	DLLA150P815	00926-P815		
59	DLLA150P866	00926-P866		
60	DLLA150P914	00926-P914	603X	
61	DLLA151P955	00926-P955	662X	
62	DLLA152P1040	00926-1040		
63	DLLA152P1058	00926-1058		
64	DLLA152P1097	00926-1097		
65	DLLA152P805	00926-P805	785X	
66	DLLA152P862	00926-P862		



共轨油嘴目录  
COMMON RAIL NOZZLE CATALOGUE

序号	参考编号	公司编号	适用的喷油器	备注
NO.	REFERENCE NO.	CO. NO	SUIT TO INJECTOR	REMARK
67	DLLA152P879	00926-P879		
68	DLLA152P929	00926-P929		
69	DLLA152P947	00926-P947	625X	
70	DLLA152P980	00926-P980	698X	
71	DLLA152P989	00926-P989		
72	DLLA153P885	00926-P885	706X	
73	DLLA153P958	00926-P958	663X	
74	DLLA155P1025	00926-1025		
75	DLLA155P1030	00926-1030		
76	DLLA155P1062	00926-1062	829X	
77	DLLA155P1090	00926-1090		
78	DLLA155P683	00926-P683	103X	
79	DLLA155P840	00926-P840		
80	DLLA155P848	00926-P848		
81	DLLA155P863	00926-P863		
82	DLLA155P941	00926-P941	847X	
83	DLLA155P948	00926-P948	658X	
84	DLLA155P965	00926-P965		
85	DLLA155P985	00926-P985		
86	DLLA157P715	00926-P715		
87	DLLA158P854	00926-P854	547X	
88	DLLA158P974	00926-P974		
89	DLLA158P984	00926-P984		
90	DLLAP154P988	00926-P988		
91	G3S33	00926-3S33		
92	G3S6	00926-G3S6		
93	DLLA155P1062	00926-1062	8290	
94	DLLA145P748	00926-P748	040X	
95	DLLA155P753	00926-P753	075X	
96	DLLA148P795	00926-P795	082X	
97	DLLA156P799	00926-P799	500X	
98	DLLA148P816	00926-P816	513X	
99	DLLA148P817	00926-P817	508X	



# 共轨油嘴目录

## COMMON RAIL NOZZLE CATALOGUE

序号	参考编号	公司编号	适用的喷油器	备注
NO.	REFERENCE NO.	CO. NO	SUIT TO INJECTOR	REMARK
100	DLLA156P846	00926-P846	536X	
101	DLLA154P881	00926-P881	786X	
102	DLLA152P917	00926-P917	602X	
103	DLLA148P924	00926-P924	613X	
104	DLLA148P932	00926-P932	624X	
105	DLLA155P939	00926-P939	767X/766X	
106	DLLA155P960	00926-P960	769X/768X	
107	DLLA150P966	00926-P966	780X/779X	
108	DLLA155P971	00926-P971	977X/974X	
109	DLLA152P981	00926-P981	699X	
110	DLLA150P1026	00926-1026	780X/779X	
111	DLLA155P1027	00926-1027	761X/760X	
112	DLLA155P1028	00926-1028	764X/763X	
113	DLLA149P1036	00926-1036	756X	
114	DLLA155P1044	00926-1044	652X	
115	DLLA158P1092	00926-1092	636X	
116	DLLA134PG3	00926-4PG3	ND-G2 P3	
117	DLLA155PS6	00926-5PS6	ND-G3 S6	
118	DLLA150PS7	00926-0PS7	ND-G3 S7	095050-019#
119	DLLA145PS32	00926-PS32	ND-G3 S32	095050-056#
120	DLLA145PS33	00926-PS33	ND-G3 S33	095050-081#/074#
121	DLLA145PS45	00926-PS45	ND-G3 S45	
122	DLLA145PS49	00926-PS49	ND-G3 S49	



共轨油嘴目录  
COMMON RAIL NOZZLE CATALOGUE

序号	参考编号	公司编号	适用的喷油器	备注
NO.	REFERENCE NO.	CO. NO	SUIT TO INJECTOR	REMARK
1	ALLA152FL025	00927-L025		
2	ALLA152FL028	00927-L028		
3	ASLA144FL120	00927-L120		
4	D456002863KGF	00927-3KGF		
5	HBX6966841	00927-6841		
6	L004CVABEBA1	00927-EBA1		
7	L012PBB	00927-L012		
8	L014PBB	00927-L014		
9	L017PBB	00927-L017		
10	L018PBB	00927-L018		
11	L025PBC	00927-L025		
12	L026PBD	00927-L026		
13	L033PBA	00927-L033		
14	L045PBL	00927-L045		
15	L060PBA	00927-L060		
16	L070PBA	00927-L070		
17	L072PBA	00927-L072		
18	L076PBD	00927-L076		
19	L079PBD	00927-L079		
20	L087PBD	00927-L087		DLLA145LP087
21	L096PBD	00927-L096	7135-652 KIT NO	DLLA154LP096
22	L097PBD	00927-L097		
23	L123PBB	00927-L123		
24	L126PBB	00927-L126		
25	L127CBA	00927-L127		
26	L129PBA	00927-L129		
27	L130PBA	00927-L130		
28	L131PBA	00927-L131		
29	L136PBD	00927-L136		
30	L137PBD	00927-L137		
31	L158PBA	00927-L158		
32	L159PBA	00927-L159		
33	L163PBD	00927-L163		







# 共轨油嘴目录

## COMMON RAIL NOZZLE CATALOGUE

序号	参考编号	公司编号	适用的喷油器	备注
NO.	REFERENCE NO.	CO. NO	SUIT TO INJECTOR	REMARK
1	DLLA153PM001	00930-M001	SIEMENS A2C595135553/5WS40252	
2	DLLA156PM002	00930-M002	SIEMENS A2C59511364/5WS40249	4H2Q9K546EA
3	DLLA153PM003	00930-M003	SIEMENS A2C59514909/5WS40156-4Z	
4	DLLA153PM004	00930-M004	SIEMENS A2C595135597/5WS40387	6H4Q9K546EB
5	DLLA153PM005	00930-M005	SIEMENS A2C59511602/5WS40200	
6	DLLA147PM007	00930-M007	SIEMENS A2C59511606	
7	DLLA155PM008	00930-M008	SIEMENS A2C59513484/5WS40536	
8	DLLA162PM011	00930-M011	SIEMENS A2C59513554/5WS40539	
9	DLLA154PM012	00930-M012	SIEMENS A2C59513556/5WS40677	
10	DLLA140PM019	00930-M019	SIEMENS BK2Q-9K546-AC	
11	DSL142PV600	00930-V600	SIEMENS 5WS40000-Z	
12	DLLA142PM604	00930-M604	SIEMENS A2C59513998/5WS40149-Z	
13	DSL144PV605	00930-V605	SIEMENS 5WS40148-Z	
14	DLLA152PM1001	00930-1001	SIEMENS A2C59511610/5WS40086	4M5Q9F593AD
15	DLLA152PM1003	00930-1003	SIEMENS A2C59511611/5WS40250	7T1Q9F593AB
16	DLLA150PM1600	00930-1600	SIEMENS 77750	



# 东港威远油泵油嘴有限公司

DONG GANG WEI YUAN FUEL INJECTION EQUIPMENT CO.,LTD.

## COMMON RAIL INJECTORS

TYPE NO.	TYPE NO.	TYPE NO.	TYPE NO.	TYPE NO.
0445110 055	0445110 448	0445120 130	0445120 290	095000-5963
0445110 064	0445110 449	0445120 134	0445120 291	095000-6221
0445110 101	0445110 454	0445120 149	0445120 292	095000-6222
0445110 123	0445110 462	0445120 150	0445120 293	095000-6223
0445110 216	0445110 465	0445120 151	0445120 304	095000-6351
0445110 290	0445110 482	0445120 152	0445120 310	095000-6352
0445110 291	0445110 486	0445120 156	0445120 318	095000-6353
0445110 293	0445110 494	0445120 157	0445120 333	095000-6363
0445110 305	0445110 511	0445120 160	0445120 334	095000-6382
0445110 307	0445110 527	0445120 163	0445120 342	095000-6581
0445110 313	0445120 002	0445120 164	0445120 352	095000-6583
0445110 317	0445120 020	0445120 165	0445120 373	095000-6591
0445110 318	0445120 040	0445120 169		095000-6592
0445110 321	0445120 059	0445120 170	095000-5003	095000-6593
0445110 333	0445120 060	0445120 191	095000-5212	095000-6631
0445110 334	0445120 066	0445120 192	095000-5213	095000-6691
0445110 335	0445120 067	0445120 213	095000-5214	095000-6692
0445110 343	0445120 074	0445120 214	095000-5215	095000-6693
0445110 345	0445120 081	0445120 215	095000-5271	095000-6700
0445110 346	0445120 083	0445120 221	095000-5341	095000-6701
0445110 348	0445120 084	0445120 222	095000-5450	095000-6790
0445110 356	0445120 086	0445120 224	095000-5461	095000-6791
0445110 359	0445120 087	0445120 225	095000-5471	095000-6860
0445110 364	0445120 106	0445120 227	095000-5473	095000-6861
0445110 365	0445120 107	0445120 231	095000-5501	095000-7172
0445110 376	0445120 110	0445120 232	095000-5502	095000-8010
0445110 380	0445120 117	0445120 236	095000-5511	095000-8011
0445110 397	0445120 121	0445120 239	095000-5512	095000-8100
0445110 417	0445120 122	0445120 244	095000-5513	095000-8900
0445110 422	0445120 123	0445120 261	095000-5514	095000-8901
0445110 432	0445120 124	0445120 265	095000-5515	095000-8902
0445110 443	0445120 126	0445120 266	095000-5516	095000-8903
0445110 445	0445120 127	0445120 277	095000-5942	095000-8980
0445110 446	0445120 129	0445120 289	095000-5960	095000-9720
320D ( 326-4700 )	236-0962			
178-0199	387-9433			
328-2574	328-2585			
387-9427				

RETURN





# 东港威远油泵油嘴有限公司

DONG GANG WEI YUAN FUEL INJECTION EQUIPMENT CO.,LTD.

## CONTROL VALVES FOR BO INJECTORS

序号	型号		序号	型号		序号	型号
1	FOOR J01 865		47	FOOR J02 067		94	FOOV C01 043
2	FOOR J01 159		48	FOOR J00 447		95	FOOV C01 057
3	FOOR J01 218		49	FOOR J01 895		96	FOOV C01 044
4	FOOR J02 175		50	FOOR J02 130		97	FOOV C01 046
5	FOOR J02 466		51	FOOR J01 176		98	FOOV C01 050
6	FOOR J01 479		52	FOOR J02 213		99	FOOV C01 053
7	FOOR J01 533		53	FOOR J02 266		100	FOOV C01 007
8	FOOR J01 657		54	FOOR J02 278		101	FOOV C01 001
9	FOOR J01 683		55	FOOV C01 331		102	FOOV C01 024
10	FOOR J01 692		56	FOOV C01 334		103	FOOV C01 045
11	FOOR J01 522		57	FOOV C01 013		104	FOOV C01 051
12	FOOR J01 704		58	FOOV C01 336		105	FOOV C01 054
13	FOOR J02 806		59	FOOV C01 378		106	FOOR J01 714
14	FOOR J01 727		60	FOOV C01 338		107	FOOR J02 004
15	FOOR J01 924		61	FOOV C01 341		108	FOOR J01 747
16	FOOR J02 035		62	FOOV C01 342		109	FOOR J01 329
17	FOOR J01 451		63	FOOV C01 344		110	FOOR J01 819
18	FOOR J02 056		64	FOOV C01 346		111	FOOR J02 012
19	FOOR J02 103		65	FOOV C01 347		112	FOOR J02 377
20	FOOR J02 472		66	FOOV C01 348		113	FOOR J02 410
21	FOOR J01 278		67	FOOV C01 352		114	FOOR J02 429
22	FOOR J00 005		68	FOOV C01 353		115	FOOR J02 449
23	FOOR J00 375		69	FOOV C01 354		116	FOOR J02 506
24	FOOR J01 941		70	FOOV C01 355		117	FOOR J02 714
25	FOOR J01 129		71	FOOV C01 357		118	FOOV C01 301
26	FOOR J00 218		72	FOOV C01 358		119	FOOV C01 303
27	FOOR J00 339		73	FOOV C01 359		120	FOOV C01 309
28	FOOR J01 945		74	FOOV C01 360		121	FOOV C01 310
29	FOOR J00 399		75	FOOV C01 363		122	FOOV C01 311
30	FOOR J00 420		76	FOOV C01 364		123	FOOV C01 312
31	FOOR J00 834		77	FOOV C01 365		124	FOOV C01 313
32	FOOR J02 454		78	FOOV C01 367		125	FOOV C01 315
33	FOOR J01 005		79	FOOV C01 368		126	FOOV C01 317
34	FOOV C01 003		80	FOOV C01 371		127	FOOV C01 323
35	FOOV C01 004		81	FOOV C01 376		128	FOOV C01 324
36	FOOV C01 005		82	FOOV C01 380		129	FOOV C01 325
37	FOOV C01 011		83	FOOV C01 383		130	FOOV C01 328
38	FOOV C01 015		84	FOOV C01 377		131	FOOV C01 329
39	FOOV C01 016		85	FOOV C01 022		132	FOOV C01 333
40	FOOV C01 052		86	FOOV C01 038		133	FOOV C01 349
41	FOOR J01 052		87	FOOV C01 023		134	FOOV C01 340
42	FOOR J01 222		88	FOOV C01 033		135	FOOV C01 306
43	FOOR J01 334		89	FOOV C01 034		136	FOOV C01 320
44	FOOV C01 356		90	FOOV C01 035		137	FOOV C01 321
45	FOOR J01 428		91	FOOV C01 036		138	FOOR J02 246
46	FOOR J02 005		92	FOOV C01 037		139	FOOR J02 386
			93	FOOV C01 042			RETURN



# 东港威远油泵油嘴有限公司

DONG GANG WEI YUAN FUEL INJECTION EQUIPMENT CO.,LTD.



## CONTROL VALVES FOR DO INJECTORS &PUMP

序号 NO.	型号 / 刻号 Type NO. / stamping NO.	匹配喷油器型号 Matche Injectors	产地 Place of Origin	产品图片 Picture	备注 Remarks
1	02#	5212/5215/5226/5512/ 5513/7649/7281/6912/ 6049/6231/295040-6230			
2	04#	5053/5220/5550/6590/ 6950/5030/5950/7850/ 7893/6490/6491			
3	06#	5470/5510/6650/8480/ 6510/6511/6551/5321/ 7060			
4	07#	7761/23670-30300/ 23670-30080			
5	10#	5125/5214/5271/5284/ 5391/5653/5780/5960/ 5963/5971/5972/6250/ 6350/6351/6352/6353/ 6360/6364/6353/6593/ 6583/6971/6890/6980/ 7172/8291/166005X30A			

序号 NO.	型号 / 刻号 Type NO. / stamping NO.	匹配喷油器型号 Matche Injectors	产地 Place of Origin	产品图片 Picture	备注 Remarks
6	31#	6222/6223/6691/6693/ 6700/6701/8100/8010/ 8011/295040-6770			
7	32#	6770/6070/295040-6120			
8	29#	5511/5459/5489/5516			
9	34#	8633/8163/8300/6652/ 8971/2491/6303/4363/ 6270/2542			
10	36#	6790/6791/6793			

序号 NO.	型号 / 刻号 Type NO. / stamping NO.	匹配喷油器型号 Matche Injectors	产地 Place of Origin	产品图片 Picture	备注 Remarks
11	19#	5230/5341/5342/5344/ 5471/5472/5473/5474/ 5475/5476/5480/5481/ 5500/5501/5502/6111/ 6300/6363/6373/6374/ 6382/6392/6420/6430/ 6900/8900/8901/8902/ 8903/5600/5619/5650/ 5690/5931/6931/7257/ 7611/8170/8930/8970/ 23670-30050/VP12			
12	18#/MTXI	0260/5050/5450/5454/ 6860/6821/9720/778#/ 23670-30240(Toyota)			
13	BF23 SFP6 XF24	5800/5801/6Q10C			
14	SF03 BGC2	23670-30420/OL090/143			
15	501#	23670-30190			

序号 NO.	型号 / 刻号 Type NO. / stamping NO.	匹配喷油器型号 Matche Injectors	产地 Place of Origin	产品图片 Picture	备注 Remarks
16	507#	0760/0761/0321/6071/ 23670-30400			
17	509#	G3			
18	504# / 505#	0231/0152/0491/1290/ 4351/0650/6022/3490/ 7880/0591/0452/0352/ 1930/1570/4990/7193/ 7870			
19	517#	095000-1440/ 23670-0L010			
20	05# (First generaion) 11E-50575711E-058250	23670-30030(11R00176) /095000-0940			

序号 NO.	型号 / 刻号 Type NO. / stamping NO.	匹配喷油器型号 Matche Injectors	产地 Place of Origin	产品图片 Picture	备注 Remarks
21	HP0 (New TYPE)	HP0 Plunger			
22	HP0(Old TYPE)	HP0 Plunger			
23		095000-0940,095000-0941 TOYOTA 23670-30030			2pcs/set

# 东港威远油泵油嘴有限公司

DONG GANG WEIYUAN FUEL INJECTION EQUIPMENT CO., L.T.D.



## EUI EUP 配件目录 EUI EUP PARTS CATALOGUE

地址：辽宁省沈阳市沈河区友好街19号奉天银座 B座 1601室

ADD:Rm B 1601 Feng Tian Yin Zuo,NO.19 You Hao Street,Shen He district,  
Shen Yang city,Liao Ning province,China,110013



Website:[www.dgweiyuan.com](http://www.dgweiyuan.com)

Email:[webmaster@dgweiyuan.com](mailto:webmaster@dgweiyuan.com)

[Tel:0086-24-88579578](tel:0086-24-88579578)

Fax:0086-24-88579568

## EUP/EUI目录 (EUP/EUI CATALOGUE)

名称 DESIGNATION	外形 MODEL	公司编号 OUR REF.	规格 SIZE	备注 REMARK
EUP		00Q-DKF (I) -0833-6.995	6.995	
		00Q-DKF (I) -0833-7.000	7.000	
		00Q-DKF (I) -0833-7.005	7.005	
		00Q-DKF (I) -0833-7.010	7.010	
		00Q-DKF (I) -0833-7.015	7.015	
		00Q-DKF (I) -0833-7.020	7.020	
		00Q-DKF (I) -0833-7.025	7.025	
		00Q-DKF (I) -0833-7.030	7.030	
		00Q-DKF (I) -0833-7.035	7.035	
		00Q-DKF (I) -0833-7.040	7.040	
		00Q-DKF (I) -0833-7.045	7.045	
		00Q-DKF (I) -0833-7.050	7.050	
		00Q-DKF (I) -0833-7.055	7.055	
		00Q-DKF (I) -0833-7.060	7.060	
		00Q-DKF (I) -0833-7.065	7.065	
		00Q-DKF (I) -0833-7.070	7.070	
EUI		00Q-DKF (II) -0833-6.995	6.995	
		00Q-DKF (II) -0833-7.000	7.000	
		00Q-DKF (II) -0833-7.005	7.005	
		00Q-DKF (II) -0833-7.010	7.010	
		00Q-DKF (II) -0833-7.015	7.015	
		00Q-DKF (II) -0833-7.020	7.020	
		00Q-DKF (II) -0833-7.025	7.025	
		00Q-DKF (II) -0833-7.030	7.030	
		00Q-DKF (II) -0833-7.035	7.035	
		00Q-DKF (II) -0833-7.040	7.040	
		00Q-DKF (II) -0833-7.045	7.045	
		00Q-DKF (II) -0833-7.050	7.050	
		00Q-DKF (II) -0833-7.055	7.055	
		00Q-DKF (II) -0833-7.060	7.060	
		00Q-DKF (II) -0833-7.065	7.065	
		00Q-DKF (II) -0833-7.070	7.070	



# 东港威远油泵油嘴有限公司

DONG GANG WEIYUAN FUEL INJECTION EQUIPMENT CO., L.T.D.



## 电装阀杆

## SHAFT SUIT FOR DENSO

地址：辽宁省沈阳市沈河区友好街19号奉天银座 B座 1601室

ADD:Rm B 1601 Feng Tian Yin Zuo,NO.19 You Hao Street,Shen He district,  
Shen Yang city,Liao Ning province,China,110013

Website:[www.dgweiyuan.com](http://www.dgweiyuan.com)

Email:[webmaster@dgweiyuan.com](mailto:webmaster@dgweiyuan.com)

[Tel:0086-24-88579578](tel:0086-24-88579578)

Fax:0086-24-88579568

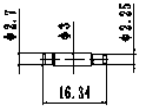
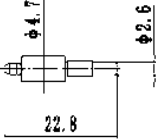
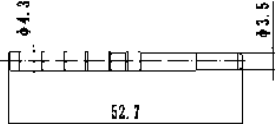
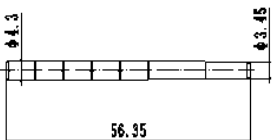
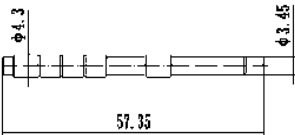
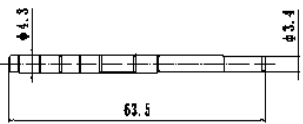
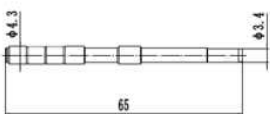

# 电装阀杆 ( SHAFT SUIT FOR DENSO )

OUTLINE DIMENSIONAL DRAWING	REF. NR	CO. NO.	SUITABLE INJECTOR TYPE
外形尺寸图	型号	公司编号	配套喷油器型号
	No. 7	00850D-0007-02	095000-1211
	No. 20	00850D-0020-02	
	5004	00850D-5004-02	095000-5004 095000-5014 095000-5342 095000-5471 095000-890# 095000-6373 095000-6364
	6980	00850D-6980-02	095000-6980
	5450	00850D-5450-02	095000-5450
	6592	00850D-6592-02	095000-6353 095000-6593 095000-6583 095000-6592 095000-6351
	7140	00850D-7140-02	095000-7140

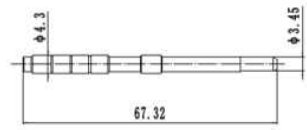
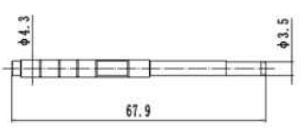
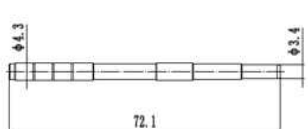
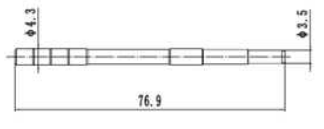
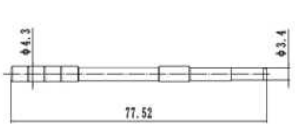
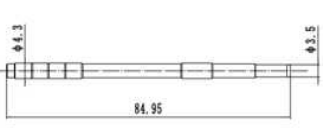
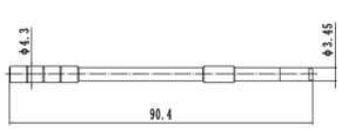
# 电装阀杆 ( SHAFT SUIT FOR DENSO )

OUTLINE DIMENSIONAL DRAWING	REF. NR	CO. NO.	SUITABLE INJECTOR TYPE
外形尺寸图	型号	公司编号	配套喷油器型号
	5215	00850D-5215-02	095000-5215
	6632	00850D-6632-02	095000-6632
	8310	00850D-8310-02	095000-8310
	6222	00850D-6222-02	095000-6222
	6700	00850D-6700-02	095000-6700 095000-8011
	05K01405	00850D-000B-02	095000-5513 095000-5511 095000-4152
	No. 19	00850D-0019-02	

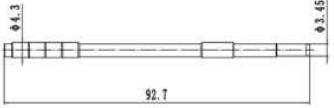
# 电装阀杆 ( SHAFT SUIT FOR DENSO )

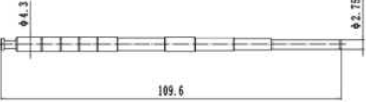
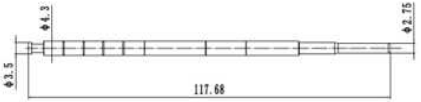
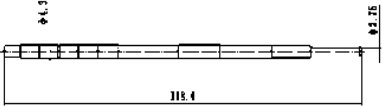
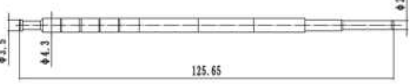
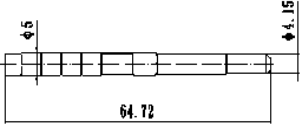
OUTLINE DIMENSIONAL DRAWING	REF. NR	CO. NO.	SUITABLE INJECTOR TYPE
外形尺寸图	型号	公司编号	配套喷油器型号
	5226	00850D-5226-02	095000-5226 095000-5223
	6790 (No. 18)	00850D-6790-02	095000-6790
	5870	00850D-5870-02	095000-5870
	5525 (23670-0L010)	00850D-0004-02	095000-5525
	No. 33	00850D-0033-02	
	5801	00850D-5801-02	095000-5801
	0812	00850D-0812-02	095000-0812

# 电装阀杆 ( SHAFT SUIT FOR DENSO )

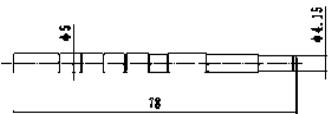
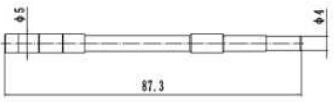
OUTLINE DIMENSIONAL DRAWING	REF. NR	CO. NO.	SUITABLE INJECTOR TYPE
外形尺寸图	型号	公司编号	配套喷油器型号
	无标	00850D-000F-02	
	1211	00850D-1211-02	095000-1211

# 东港威远油泵油嘴有限公司

DONG GANG WEIYUAN FUEL INJECTION EQUIPMENT CO., L.T.D.



## 博世阀杆

## SHAFT SUIT FOR BO

地址：辽宁省沈阳市沈河区友好街19号奉天银座 B座 1601室

ADD:Rm B 1601 Feng Tian Yin Zuo,NO.19 You Hao Street,Shen He district,  
Shen Yang city,Liao Ning province,China,110013

Website:[www.dgweiyuan.com](http://www.dgweiyuan.com)

Email:[webmaster@dgweiyuan.com](mailto:webmaster@dgweiyuan.com)

[Tel:0086-24-88579578](tel:0086-24-88579578)

Fax:0086-24-88579568

# 博世阀杆 ( SHAFT SUIT FOR B0 )

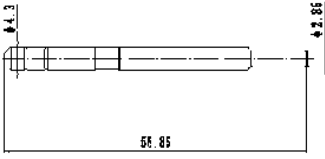
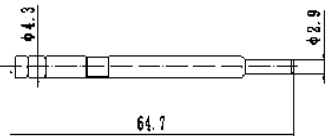
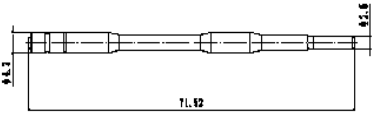
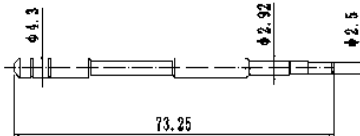
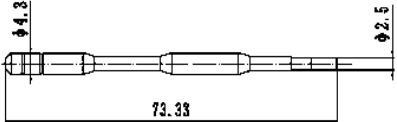
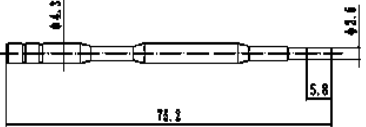
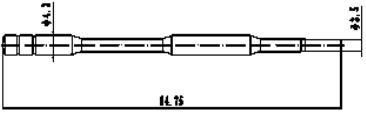

OUTLINE DIMENSIONAL DRAWING	REF. NR	CO. NO.	SUITABLE INJECTOR TYPE
外形尺寸图	型号	公司编号	配套喷油器型号
	F 00R J02 005	00850B-2005-02	
	6/0848 321 29105	00850B-9105-02	
	F 00V C01 365	00850B-1365-02	
	060 2015 78927 1 0934 W	00850B-0934-02	
	F 00R J02 130	00850B-2130-02	
	F 00R J02 472	00850B-2472-02	
	F 00V C01 359	00850B-1359-02	

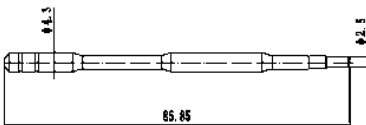
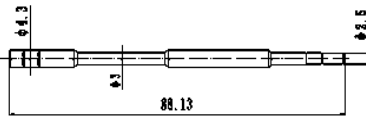
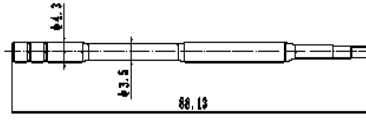
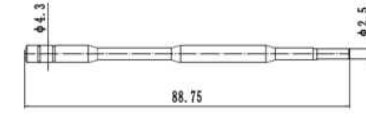
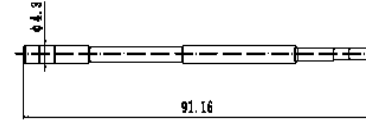
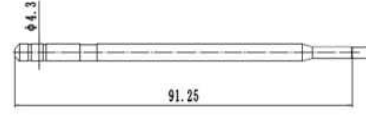
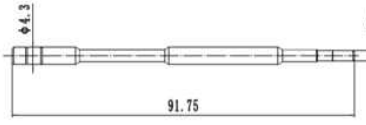
# 博世阀杆 ( SHAFT SUIT FOR B0 )



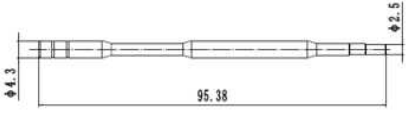
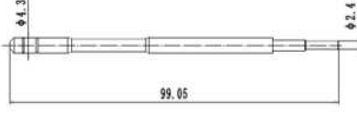
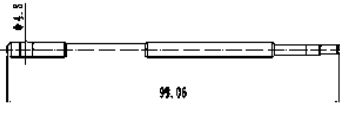
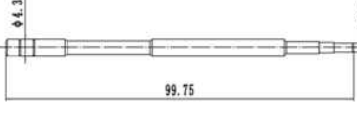

OUTLINE DIMENSIONAL DRAWING	REF. NR	CO. NO.	SUITABLE INJECTOR TYPE
外形尺寸图	型号	公司编号	配套喷油器型号
	F 00R J01 941	00850B-1941-02	
	117 J 654 78711 3 1513	00850B-1513-02	
	F 00R J02 806	00850B-2806-02	
	No. 26	00850B-0026-02	
	无标	00850B-000D-02	
	F 00R J02 067	00850B-2067-02	
	0436 J 654 78405 2 0266	00850B-0266-02	

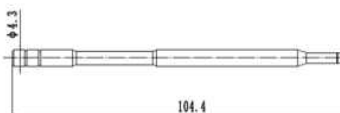
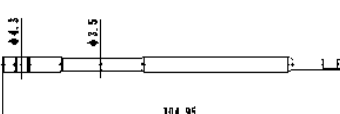



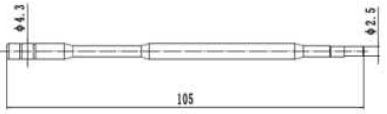
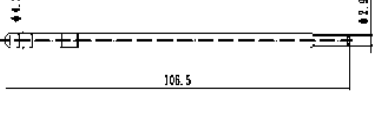
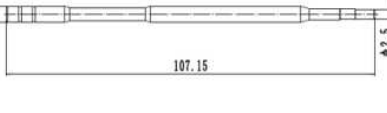

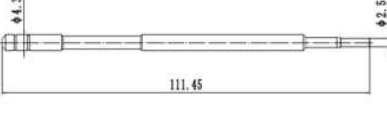
# 博世阀杆 ( SHAFT SUIT FOR BO )

OUTLINE DIMENSIONAL DRAWING	REF. NR	CO. NO.	SUITABLE INJECTOR TYPE
外形尺寸图	型号	公司编号	配套喷油器型号
	F 00R J01 479	00850B-1479-02	
	060 C03055	00850B-9029-02	
	1/0527 C 056 48323	00850B-8323-02	
	无标	00850B-000E-02	
	No. 12	00850B-0012-02	
	F00R J01 657	00850B-1657-02	
	083 R 654 78521 M 5/0901	00850B-0901-02	

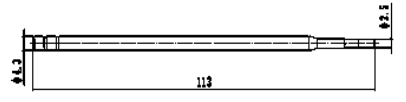
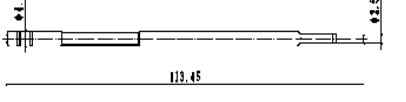

# 博世阀杆 ( SHAFT SUIT FOR B0 )

OUTLINE DIMENSIONAL DRAWING	REF. NR	CO. NO.	SUITABLE INJECTOR TYPE
外形尺寸图	型号	公司编号	配套喷油器型号
	F 00R J01 692	00850B-1692-02	
	No. 17	00850B-0017-02	
	F 00R J01 727	00850B-1727-02	
	No. 11	00850B-0011-02	
	F 00V C01 051	00850B-1051-02	
	No. 16	00850B-0016-02	
	No. 14	00850B-0014-02	

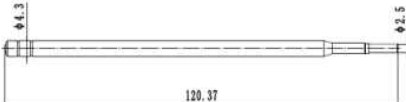
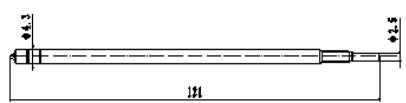
# 博世阀杆 ( SHAFT SUIT FOR BO )

OUTLINE DIMENSIONAL DRAWING	REF. NR	CO. NO.	SUITABLE INJECTOR TYPE
外形尺寸图	型号	公司编号	配套喷油器型号
	F 00R J02 056	00850B-2056-02	
	No. 30	00850B-0030-02	
	No. 13	00850B-0013-02	
	No. 3	00850B-0003-02	
	No. 8	00850B-0008-02	
	F00V C01 363	00850B-1363-02	
	No. 10	00850B-0010-02	

# 博世阀杆 ( SHAFT SUIT FOR B0 )

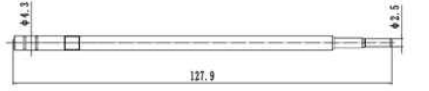

OUTLINE DIMENSIONAL DRAWING	REF. NR	CO. NO.	SUITABLE INJECTOR TYPE
外形尺寸图	型号	公司编号	配套喷油器型号
	F 00V C01 044	00850B-1044-02	
	F00V C01 383	00850B-1383-02	
	No. 2	00850B-0002-02	











# 东港威远油泵油嘴有限公司



DONG GANG WEI YUAN FUEL INJECTION EQUIPMENT CO.,LTD.

## SCV VALVE



序号 NO.	型号 / 刻号 Type NO. / stamping NO.	适用泵号 Matched pumps	配合发动机 Fit Engine	产地 Place of Origin	产品图片 Picture	备注 Remarks
1	294200-0190 294200-0170 294000-0167	294050-0080 294050-0090 294050-0110 294050-0130 294050-0160 294050-0190	Nissan MPV/Hatchback/Saloon Estate 2003--2008-2.2 dCi engine:J05E denso HP3 DENSO HP4 pump			
2	294009-1221 04226-E0061	294200-0270 294000-0290 294000-0294 294000-0822 04226-E0040 04226-E0030 294000-0291 294000-0292 294000-0820 294000-0821 sk260-8 e265bj	锡柴、上柴、日野 五十铃等电装HP3泵			
3	294009-0260 294200-0360 294009-0230 294200-0160 A6860-VM09A SM294009 -0251	294009-1110 294009-0251 294009-0250 0360 02Q18 1460A037 294009-02514 294009-1110	TD DIESEL 2006-2015 MITSUBISHI PAJERO SHOGUN 3.2 DI-D MITSUBISHI L200 2.5 DI-D 2005-ONWARDS ( TRITON 4D56, 4M41, PAJARO 4M41 ) CITROEN RELAY 2.2 HDI 100 / 120 -PEUGEOT BOXER 2.2 HDI 100 / 120 -FIAT DUCATO 100 MULTIJET 2.2 D Mazda 3/5/6 : 294000-0420 294000-0620 NISSAN CABSTAR /NAVARA /PATHFINDER 294000-0530 YD25DDTI MITSUBISHI 294000-0640 294000-03334D56 PEUGEOT 1. BOXER 2, 2 HDI : 294000-0400			

序号 NO.	型号 / 刻号 Type NO. / stamping NO.	适用泵号 Matched pumps	配合发动机 Fit Engine	产地 Place of Origin	产品图片 Picture	备注 Remarks
4	294200-0300 294200-0301	294000-0603 294000-0310 294000-0350 294000-0360 294000-0380 294000-0430 294000-0440 294000-0540 294000-0860 294000-0870	TOYOTA 1AD, 2AD, 1KD, 2KD TOYOTA Auris , Avensis, Corolla Verso, Dyna, Hiace, Hilux, Land Cruiser, RAV4			
5	294009-0370		SCV DENSO MITSUBISHI PAJERO, L200 MAZDA 6			
6	A6860EC09A		NISSAN - - NAVARA (D40)-2.5 dCi 4WD NAVARA (D40) - 2.5 dCi 4WD			
7	294200-0650 8-98043687-0		神钢SK200-8 J05 挖掘机日野电装高压燃油泵 VALFI HYUNDAI , ISUZU TOYOTA , HINO, YENIBOSNA DENSO SCV ( ) 24V 8.5 Ohms for Fuel pressure regulation valve ISUZU 4HK1 and other 五十铃 D-MAX/4JA1 4JA1-T 4JH1 4JJ1 4JK1ISUS KB/C190 C223 C240 TFR/4JA1 4JA1-TC 4JB1-TC NPR/4HF1 4HG1 4HG1-TC 4HK1 -TC 4HE1-TC 4B2C 4BD1 4BE1 FSR/6BD1 6BG1 6HH1 6HE1 6HK1 NKR/4JB1 4BJ1-TC4JH1-TC 马自达 马自达2马自达 MAZ DA5 MAZDA6家庭普利CX-7 本田 雅阁/CF9-CG1-CG5 CM4 -CM5-CM6 CP1-CP2-CP3 奥德赛/RA6 RB1 RB3 市/GD1-GD3 GD6 GD8 CE6- CE8 GM2-GM3 CR-V/RD5-RD7 RE2-RE4 RM1- RM2-RM4 CU1 CU2			

序号 NO.	型号 / 刻号 Type NO. / stamping NO.	适用泵号 Matched pumps	配合发动机 Fit Engine	产地 Place of Origin	产品图片 Picture	备注 Remarks
8	294200-0042 294200-0041 294200-0040 04226-0L020	294000-0010 294000-0060 294000-0100 294000-0110 294000-0170 294000-0350 294000-0360 294000-0430 294000-0440 294000-0540 294000-0550 294000-0700 294000-0850 294000-0900 294000-0910 294000-0920 294000-1100 294009-0280	SCV (suction control valve) TOYOTA VIGO, FORTUNER, PRADO 1KD-FTV VIGO, INNOVA, COMMUTER 2KFTV 22560-300020			
9	294200-0670 8981305080 898181830 294200-0670 294009-0590 294009-0860	294050-0060 294050-0040 294050-0070 294050-0090 294050-0100 294050-0130 294050-0160 294050-0200 294050-0220 294050-0290 294050-0460 294050-0500 294050-0080 294050-0110 294050-0210	Fuel pressure regulation valve 24V 8.5 Ohms for ISUZU 6HK and other			
10	294200-2760		Fuel pressure regulation valve 24V 8.5 Ohms for ISUZU 4JK1 , 4JJ1 New MIT 4D56 , and 4M41			
11	294009-0730 8-98145453-0	294200-2760	12V 2.1 ohms (with adaptor kit) for ALL ISUZU light truck & passenger (D-MAX , 4JK1-T & 4JJ1-T AND MU7 4JJ-T)			

序号 NO.	型号 / 刻号 Type NO. / stamping NO.	适用泵号 Matched pumps	配合发动机 Fit Engine	产地 Place of Origin	产品图片 Picture	备注 Remarks
12	294200-0660		made in Japan 12 V for Nissan Mazda YD25, Mitsubishi4D56, 4M41			
13	294009-0120		0819185 , 98043686 COMBO (08.2003 - ...) 8-97313862-#), Z17DTH CORSA C (8-97313862-#) silniki: Z17DTH MERIVA (8-97313862-#) silniki: Z17DTH N-SERIES (8-97328886-0) silniki: 4HK-1 MAZDA6 (RF5C13800) silniki: RF-DI MPV (RF5C13800) silniki: RF-DI  ALMERA, ALMERA TINO HU294000-016#) YD22 CABSTAR, Euro-5 (HU294000-122#) silniki: YD25 PATHFINDER (294000-037#) silniki: YD25 PATHFINDER (HU294000-122#) silniki: YD25 PRIMERA silniki: YD22 MURANO (HU294000-122#) silniki: YD25 NAVARA YD25, Euro5 X-TRAIL, silniki: YD22  PAJERO / MONTERO (1460A040 -A059) 4M41 DI-DC JOHN DEERE (RE507959)			
14	294200-0040 294200-0042		TOYOTA 2.0 D4D AVENSIS (T25) 294000 -01021CD-FTV AVENSIS (T25) 294000 -0065 1CD-FTV COROLLA (E12) 294000 -01021CD-FTV			



序号 NO.	型号 / 刻号 Type NO. / stamping NO.	适用泵号 Matched pumps	配合发动机 Fit Engine	产地 Place of Origin	产品图片 Picture	备注 Remarks
15	294200-0040 294200-0042		DYNA 294200-00192KD-FTV HILUX 294200-0019KD-FTV 4-RUNNER294200-00192KD-FTV TOYOTA HILUX 2001-2014 1KD-FTV / 2KD FTV DIESEL ENGINE HP3 1CD-FTV			
16	8-98145455-0 294009-0740 294200-2760		without adaptor kit) for ISUZU LIGHT TRUCK & PASSENGER SCV(294200-2760 made in Japan) 12V ,2.1 ohms (without adaptor kit) for ISUZU LIGHT TRUCK & PASSENGER			
17	04226-0L010 294200-0040 22560-30020 294200-0093		04226-0L010 ( 294200-0040 ) 12 V ,2.1 TOYOTA VIGO, FORTUNER, PRADO 1KD-FTV VIGO, INNOVA, COMMUTER 2KFTV T25 2,0 D-4D 93KW, Bj. 2006-2009			













# 东港威远油泵油嘴有限公司

DONG GANG WEI YUAN FUEL INJECTION EQUIPMENT CO.,LTD.





## FUEL METERING VALVE UNIT



序号 NO.	型号 / 刻号 Type NO. / stamping NO.	适用泵号 Matched pumps	配合发动机 Fit Engine	产地 Place of Origin	产品图片 Picture	备注 Remarks
1	0928400617		FAW 解放 6.6D 东风 DCI11st 311.0 玉柴 YC61 8.4 玉柴YC6M 9.8			
2	0928400802		玉柴4FA 2.7 116kw YNN4 D30TCI3.0 129 kw FAW201 2.2 54 kw CHO3 3.9 70 kw			
3	0928400689		玉柴YC4G 金龙 5.2D 210 kw 玉柴YC4E 4.3D 180 kw 玉柴YC6J 6.5D 199 kw FAW24 CA4DF 5.1170 kw			
4	0928400818		CP1H 玉柴4F			
5	0928400607		PEUGEOT 206 207 307 308 PEUGEOT 407 PARTNER PEUGEOT 3008 1007 5008 BIPPER EXPERT FORD FIESTA C-MAX FOCUS CITROEN C2 C3 C4 C5 CITROEN BERLINGO CITROEN NEMO XSARA			
6	0928400680		阿尔法. 罗密欧 147 MITO 阿尔法. 罗密欧 159 FIAT MULTIPLA STRADA OPEL VECTRA ASTRA CORSA VAUXHALL VECTRA Mk II FIAT sedici 19D OPEL AstraH Signum OPEL VectraC OPEL Zafira CDTI SAAB 9.5 TID			







序号 NO.	型号 / 刻号 Type NO. / stamping NO.	适用泵号 Matched pumps	配合发动机 Fit Engine	产地 Place of Origin	产品图片 Picture	备注 Remarks
7	0928400680		CR system 阿尔法.罗密欧 147 MITO 阿尔法.罗密欧 159 FIAT MULTIPLA STRADA OPEL VECTRA ASTRA CORSA VAUXHALL VECTRA Mk II FIAT sedici 19D OPEL AstraH Signum OPEL VectraC OPEL Zafira CDTI SAAB 9.5 TID			
8	0928400681 5001867926 0928400575		CITROEN, Picasso 16c HDI 04 FORD, C.Max 16c TDCI 03 Focus 16c TDCI 04 PEUGEOT, 206 16c HDI 04 PEUGEOT, 307 14 HDI PEUGEOT, 407 14c HDI 04			
9	0928400691		BMW E87, E90, E60 BMW E63, E65 BMW X3, X5, X6			
10	71736790 0928400660 504097961 42554784 0928400567		FIAT DUCATO IVECO Daily 35C14 35C17 IVECO Daily 40C17 IVECO Daily 50C14 50C17 IVECO Daily 65C14 65C17			
11	0928400643 0928400492		PEUGEOT206 307 1.4HDI 50kw  CITROEN XSARA 14i HDI 03			
12	1638153 42541851 0928400481 4937597		Iveco140E24...150E18...180E21 Iveco crossway euroruder heuliez Iveco MIDIRIDER ML100 PROVAV Iveco PROXYS RG12 Ford Cargo 3.9 125kw Volkswagen 13. 170, 8. 150... 110/184kw Iveco 100E17... 120E18...130E18... Iveco 65E13...75E15...110/202			

序号 NO.	型号 / 刻号 Type NO. / stamping NO.	适用泵号 Matched pumps	配合发动机 Fit Engine	产地 Place of Origin	产品图片 Picture	备注 Remarks
13	0928400625		Volvo C30 C70 2.4D Volvo S40 S60 2.4D S80 V50 V70 XC60 2.4D S80 XC70 XC90 2.4D			
14	0928400726 71754810		FIAT DUCATO 120 F1AE0481D IVECO DAILY F1AE0481FA FIAT DUCATO 130 F1AE3481D UAZ PATRIOT F1AE0481A			
15	BC3Q-9J307-AA 0928400782 LR023169		Land Rover Discovery IV 3.0 SD TD V6 Land Rover Range Rover sport (LS) 3.0TD			
16	0928400666 4932457		5.9L Dodge Cummins Injection BOSCH CP3 system ml			
17	0928400487		NISSAN INTERSTAR PRIMASTAR OPEL MOVANO VIVARO RENAULT ESPACE IV RENAULT GRAND SCÉNIC II LAGUNA II RENAULT MEGANE II RENAULT TRAFIC II Engine 22 25DCI			







序号 NO.	型号 / 刻号 Type NO. / stamping NO.	适用泵号 Matched pumps	配合发动机 Fit Engine	产地 Place of Origin	产品图片 Picture	备注 Remarks
18	0928400633		现代索兰托33100-4A400 现代索兰托33100-4A410 起亚全新索兰托2.5 CRDI 125KW 起亚全新索兰托2.5 VGT 128KW 现代H-1货物2.5 CRDI 125KW			
19	0928400706 03L130755 03L130755A		AUDI A3 (8P1) (8PA) AUDI A4 (8K2) (8KH) (8K5) AUDI A5 (8T) A6 (4F2) (4F5) AUDI Q5 (8R) AUDI TT (8J3) (8J9) SEAT ALTEA EXEO SKODA OCTAVIA SUPERB YETI VW GOLF MULTIVAN V VW PASSAT TIGUAN TRANSPORTER V			
20	0928400739 42560782 504197201 8029205		FIAT DUCATO IVECO 35C14 35C15 IVECO 40C15 40C18 IVECO MASSIF			
21	0928400508 A6460740084		Mercedes Vito, Sprinter, C200, C220, CLK220 Mercedes E200 E220 E270 E280 S320 Sprinter 209 211 213 215 309 311 Sprinter 313 315 411 415 416 509 511 515 Viano 65/150 kw			
22	0928400667		FIAT DUCATO BZ / DS FIAT, Serie : Ducato 23c JTD, IVECO, Serie Daily 29L 35C 40C 50C 23c			







序号 NO.	型号 / 刻号 Type NO. / stamping NO.	适用泵号 Matched pumps	配合发动机 Fit Engine	产地 Place of Origin	产品图片 Picture	备注 Remarks
23	0928400567 504070403		FIAT DUCATO IVECO Daily 35C14 35C17 IVECO Daily 40C17 IVECO Daily 50C14 50C17 IVECO Daily 65C14 65C17			
24	0928400770		Renault MeganeIII, Scenic, 2.0 DCI			
25	0928400655					
26	0928400783					
27	0928400627 51 12505 0027		MAN TGA 10.5 ALL serie			







序号 NO.	型号 / 刻号 Type NO. / stamping NO.	适用泵号 Matched pumps	配合发动机 Fit Engine	产地 Place of Origin	产品图片 Picture	备注 Remarks
28	0928400728		中兴皮卡 长兴SUV 江铃 2.5VM 105KW 一汽CA4DC 88kw 长城 哈弗/风骏 4cyl. _ 2.8L TC TCI 江铃 皮卡 4JB1 TC 68KW 奇瑞B14 1.9L_B14 B11 93kw 尼桑 帕拉丁 新晨 2.5L 109KW 福田 轻卡/皮卡 4JB1 TC TCI 福田4D24 一汽锡柴4DF 6DM2 6DN1(6JM1) 华晨 骏捷/尊驰 云内 4D19 TCI 84KW 云内 4D19 TCI 84kw 114kw 江淮/福田/宇通卡车 朝 柴 4102H 75kw 江铃卡车 朝柴 4D47 115kw 江淮轻卡 瑞风 4cyl. _ 2.8L 80kw 福田轻卡 全柴 4D22E 2.2L 65kw 依维柯 都灵 sofim8140 92kw 康明斯 ISBe 305kw 415kw 陕汽 德龙 潍柴 WP6 WP12 WD10 康明斯ISLe 玉柴YC6L 朝柴4102TCI 东风十堰Dci11_st2 310kw			
29	0928400498		BMW 330D 330XD 520D 530D 730LD X3 330D 330XD 520D 530D 730LD X3 20c 30c			
30	0928400568 504 0704 03 45 02 2054F		LDV MAXUS 2.5CDI			







序号 NO.	型号 / 刻号 Type NO. / stamping NO.	适用泵号 Matched pumps	配合发动机 Fit Engine	产地 Place of Origin	产品图片 Picture	备注 Remarks
31	0928400616		Volvo S60 S80 V70 XC70 XC90 92/136 kw			
32	0928400620 0928400543		MAN TGA 12.8 ALL serie CR/CP3S3/L125/40-789S CR/CP3S3/L125/40-789S			
33	0928400636		scorpio 2.6 CRDe			
34	0928400640		AMU 4.8 ALL serie GAZ 4.8 ALL serie KUR3 4.8 MAS 4.8 ALL serie MMZ 4.8 ALL serie MTZ Belarus 4.8 PAB 4.8 ALL serie			
35	0928400652		Avante HD 1.6 VGTCRDI Verna, Click 1.5 VGT CRDI Picanto 1.1 CRDI Cerato, Pride new 1.5 VGT CRDI Rio 1.5 CRDI			
36	0928400654 0928400493		OPEL, Serie : AstraG AstraH, Engine 17c CDTI			













序号 NO.	型号 / 刻号 Type NO. / stamping NO.	适用泵号 Matched pumps	配合发动机 Fit Engine	产地 Place of Origin	产品图片 Picture	备注 Remarks
37	0928400655		DOGE Sprinter 3500 2.7 Vito 109 CDI Sprinter 209 211 213 215 309 311 Sprinter 313 315 411 415 416 509 511 515 Viano CDI 2.2			
38	0928400656		ALFA ROMEO, Serie : 159 FIAT, Serie Cromo LANCIA, Serie Thesis			
39	0928400664		Citroen Fiat Ford 2.2 HDI TDCI JTD Lancia Peugeot 2.2 HDI TDCI JTD Land Rover 2.2 HDI TDCI JTD			
40	0928400669		Captiva, Epica, lacetti , Nubira 2.0 CRDi Daewoo winstorm 2.0Vcdi OPEL Astra 2.0 CDTI			
41	0928400671		NISSAN Cabstar, Patrol, TK55 DFL96 3.0 Mascott 130 150			
42	0928400672		RENAULT: Master 25c DCI NISSAN: Interstar Primastar 25c DCI			







序号 NO.	型号 / 刻号 Type NO. / stamping NO.	适用泵号 Matched pumps	配合发动机 Fit Engine	产地 Place of Origin	产品图片 Picture	备注 Remarks
43	0928400674		Toyota Yaris 1.4 55 kw MINI One 14c D			
44	0928400676 0928400572		Audi A4 A6 A8 2.7 3.0 TDI VW crafter 2.5 TDI VW g1of 1.6 VW phaeton touareg 3.0 TDI			
45	0928400677		Mercedes Vito 120 Sprinter 218 318 418 518 C320 CLK320 E280 E320 GL320 ML280 ML320 R280 R320 Viano30 CDI			
46	0928400679		Nissan Primaster, Qasshqai, X-trail 2.0 DCI OPEL vivaro 2.0 CDTI KOLEOS, Trafic, laguna III 2.0 DCI			
47	0928400681		Citroen Xsara Ricasso 1.6 80 kw Ford Focus C-Max, Focus II 1.6 80 kw Peugeot 206, 307, 407 1.6 HDI 80 kw Volvo S40, V50 1.6D 81kw			
48	0928400682		HYUNDAI, serie:Grandeur i30 Santafè Sonata Tucson, KIA, Serie:Carens Sportage Lotze			







序号 NO.	型号 / 刻号 Type NO. / stamping NO.	适用泵号 Matched pumps	配合发动机 Fit Engine	产地 Place of Origin	产品图片 Picture	备注 Remarks
49	0928400687		Accord、CRV、CIVIC、 FRV 2.2 CTDI			
50	0928400699		FORD Cargo			
51	0928400700		Renault Espace, Laguna, Scenic, Nissan Primastar, Trafic, Velsatis Engine 20c DCI M9R			
52	0928400712 0445020043		cummins ISF 3.8、ISBE 3.9 5.9 东风,DAF、CF、LF			
53	0928400713		现代STAREX (H1) 起亚SORENTO WGT Hyundai H-1 2.5 CRDi 103 kw Kia Sorento 2.5 CRDi 103 kw			
54	0928400714		Renault Megane, Laguna, Scenic, 1.9 DCI			

序号 NO.	型号 / 刻号 Type NO. / stamping NO.	适用泵号 Matched pumps	配合发动机 Fit Engine	产地 Place of Origin	产品图片 Picture	备注 Remarks
55	0928400715		BT-50 2.5 3.0 TDI			
56	0928400721		VW LT 28, LT 35, LT 46 2.8 TDI 116 kw			
57	0928400724 8370 69148					
58	0928400725		MERCEDES: C30AMG E400 G400 ML400 S400			
59	0928400726		FIAT, Serie: Ducato 23c JTD, IVECO, Serie Daily 29L 35C 40C 50C 23c			
60	0928400736		CHVROLET Blazer、S10 2.8D			







序号 NO.	型号 / 刻号 Type NO. / stamping NO.	适用泵号 Matched pumps	配合发动机 Fit Engine	产地 Place of Origin	产品图片 Picture	备注 Remarks
61	0928400738		CHRYSLER Voyager 2.8 CRD DODGE NITRO 2.8 CRD JEEP LIBERTY 2.8 CRD			
62	0928400743		RENAULT:Master 25c DCI NISSAN:Interstar Primastar 25c DCI			
63	0928400744		ALFA ROMEO, Serie:147 159 FIAT, Serie : Bravo Doblò Multipla Stilo, LANCIA, Serie Musa			
64	0928400746		NEOPLAN Trendliner 10.5			
65	0928400750		现代 起亚CP1共轨油泵			
66	0928400752					

序号 NO.	型号 / 刻号 Type NO. / stamping NO.	适用泵号 Matched pumps	配合发动机 Fit Engine	产地 Place of Origin	产品图片 Picture	备注 Remarks
67	0928400756		Land Rover Discovery IV 3.0 SD TD V6 Land Rover Range rover sport (LS) 3.0 TD			
68	0928400759					
69	0928400761		MAN TGL、 TGM 、 4.6 .6.9 all serie			
70	0928400768					
71	0928400791		IVECO Daily			



序号 NO.	型号 / 刻号 Type NO. / stamping NO.	适用泵号 Matched pumps	配合发动机 Fit Engine	产地 Place of Origin	产品图片 Picture	备注 Remarks
72	0928400822		JEEP LIBERTY 2.8 CRD			
73	0928400707					
74	0928400473					
75	0928400667		FIAT DUCATO 2.3			
76	0928400735					
77	0928400512					







序号 NO.	型号 / 刻号 Type NO. / stamping NO.	适用泵号 Matched pumps	配合发动机 Fit Engine	产地 Place of Origin	产品图片 Picture	备注 Remarks
78	0928400535		CHVROLET Silverado 2500 3500 6.6 GMC sierra 6.6			
79	0928400574 0928400653		GMC sierra 6.6			
80	0928400612		MERCEDES, Serie : A160 A180 A200 B180 B200			
81	0928400789		Volvo VM210 VM260 VM310			
82	0928400790					
83	0928400804					













序号 NO.	型号 / 刻号 Type NO. / stamping NO.	适用泵号 Matched pumps	配合发动机 Fit Engine	产地 Place of Origin	产品图片 Picture	备注 Remarks
84	0928400805					
85	0928400806					
86	0928400810					
87	0928400812		Nissan Primaster, Qasshqi, X-trail 2.0 DCI OPEL vivaro 2.0 CDTI Renault Espace, Laguna, Koleos 2.0 DCI			
88	0928400816					
89	0928400825					

序号 NO.	型号 / 刻号 Type NO. / stamping NO.	适用泵号 Matched pumps	配合发动机 Fit Engine	产地 Place of Origin	产品图片 Picture	备注 Remarks
90	0928400834					
91	0928400837					
92	0928400838					
93	0928400839					
94	0928400624					
95	0928400626		BMW E65 740D			







序号 NO.	型号 / 刻号 Type NO. / stamping NO.	适用泵号 Matched pumps	配合发动机 Fit Engine	产地 Place of Origin	产品图片 Picture	备注 Remarks
96	0928400634					
97	0928400642					
98	0928400644		FORD Cargo 3.9 5.9 ford F250			
99	0928400646		Mitsubishi canter 4.9			
100	0928400653		GMC sierra 6.6			
101	0928400665					

序号 NO.	型号 / 刻号 Type NO. / stamping NO.	适用泵号 Matched pumps	配合发动机 Fit Engine	产地 Place of Origin	产品图片 Picture	备注 Remarks
102	0928400673		CHVROLET Silverado 2500 3500 6.6 CHVROLET express 2500 3500 6.6			
103	0928400678					
104	0928400690		Mitsubishi canter-65 6c18 4.9 Mitsubishi canter-75 7c18 4.9			
105	0928400693					
106	0928400695					
107	0928400698		toyota Auris、IQ 1.4D toyota corolla、Yaris 1.4D subaru trezia 1.4D			

序号 NO.	型号 / 刻号 Type NO. / stamping NO.	适用泵号 Matched pumps	配合发动机 Fit Engine	产地 Place of Origin	产品图片 Picture	备注 Remarks
108	0928400701		Mercedes E420 GL420 ML420 S420 Mercedes ML450 GL450 S450			
109	0928400702		东风DAF ISDE 8.9			
110	0928400703					
111	0928400710		Mercedes A160 A180 A200 CDI			
112	0928400711		DODGE RAM 2500 3500 6.7			
113	0928400716		BMW E38 740D			

序号 NO.	型号 / 刻号 Type NO. / stamping NO.	适用泵号 Matched pumps	配合发动机 Fit Engine	产地 Place of Origin	产品图片 Picture	备注 Remarks
114	0928400717					
115	0928400718					
116	0928400720					
117	0928400722					
118	0928400727		Mitsubishi canter-35 55 65 75 3.0			
119	0928400733					

序号 NO.	型号 / 刻号 Type NO. / stamping NO.	适用泵号 Matched pumps	配合发动机 Fit Engine	产地 Place of Origin	产品图片 Picture	备注 Remarks
120	0928400741					
121	0928400742					
122	0928400745					
123	0928400751		BMW E70 X5 3.0			
124	0928400753					
125	0928400754		MAN TGL、TGM 6.9 all serise			

序号 NO.	型号 / 刻号 Type NO. / stamping NO.	适用泵号 Matched pumps	配合发动机 Fit Engine	产地 Place of Origin	产品图片 Picture	备注 Remarks
126	0928400755		MAN TGX 16.2 ALL serie			
127	0928400760					
128	0928400763		Mercedes Sprinter 219 319 419 519 E300 ML300 G300 CDI E350 blue tech ML350 GL350 S350			
129	0928400765		IVECO stralis 8.7 all type			
130	0928400766		MAN lion's city 10.5 all type MAN TGS 10.5 12.4 all type MAN NG、NL 10.5 all type MAN TGX 12.4 10.5 all type			
131	0928400769		OPEL MOVANO 2.3 VIVARO 2.0			



序号 NO.	型号 / 刻号 Type NO. / stamping NO.	适用泵号 Matched pumps	配合发动机 Fit Engine	产地 Place of Origin	产品图片 Picture	备注 Remarks
132	0928400771					
133	0928400772		Volvo VM210 VM260 VM310 7.2			
134	0928400774		FORD Cargo 4.5 6.7			
135	0928400794		长丰猎豹 扬子皮卡 FAW 2.8D 广汽GONOW 2.0 东风皮卡 黄海 2.8 江淮 JMC 轻卡 2.8D 金杯 2.8			
136	0928400801		FAW 3.8			

序号 NO.	型号 / 刻号 Type NO. / stamping NO.	适用泵号 Matched pumps	配合发动机 Fit Engine	产地 Place of Origin	产品图片 Picture	备注 Remarks
137	0928400809					
138	0928400630					
139	0928400670		Volvo FE240 FE280 FE320 7.1			
140	0928400709		scorpio 2.2 CRDe			



# 东港威远油泵油嘴有限公司

DONG GANG WEI YUAN FUEL INJECTION EQUIPMENT CO.,LTD.

## Solenoid/Coil for injectors & pumps

序号 NO.	型号 Type NO.	适用喷油器型号 Suitable for Injector Model	产地 Place of Origin	产品图片 Product pictures	备注 Remarks
1	FOOVC30318	0445110183 0445110347 0445110691 0445110291 0445110355 0445110629 0445110293 0445110357 0445110710 0445110301 0445110358 0445110752 0445110304 0445110359 0445110787 0445110305 0445110361 0445110447 0445110313 0445110365 0445110692 0445110317 0445110376 0445110735 0445110318 0445110454 0445110780 0445110321 0445110466 0445110792 0445110332 0445110486 0445110796 0445110333 0445110511 0445110799 0445110334 0445110512 0445110335 0445110594 0445110343 0445110623 0445110345 0445110637 0445110346 0445110690			
2	FOOVC30319	0445110247 0445110442 0445110280 0445110558 0445110281 0445110356			
3	FOORJ02697	0445120007 0445120121 0445120008 0445120122 0445120019 0445120123 0445120020 0445120236 0445120040 0445120238 0445120059 0445120273 0445120060 0445120376 0445120084 0445120041 0445120134			
4	FOORJ02703	0445120066 0445120149 0445120215 0445120067 0445120150 0445120217 0445120078 0445120156 0445120225 0445120081 0445120160 0445120068 0445120083 0445120163 0445120161 0445120086 0445120164 0445120162 0445120087 0445120165 0445120167 0445120102 0445120166 0445120199 0445120106 0445120169 0445120204 0445120110 0445120170 0445120327 0445120110 0445120170 0445120387 0445120117 0445120182 0445120447 0445120117 0445120183 0445120127 0445120200 0445120129 0445120213 0445120130 0445120214			

序号 NO.	型号 Model	适用喷油器型号 Suitable for Injector Model	产地 Place of Origin	产品图片 Product pictures	备注 Remarks
5	FOORJ00395	0445120002			
6	FOOVC30057	0445110126			
7	FOOVC30058	0445110038 0445110059 0445110087 0445110091 0445110141 0445110185 0445110222 0445110223 0445110283 0445110306 0445110063 0445110084 0445110092 0445110102 0445110186 0445110221 0445110231 0445110279 0445110336			
8	FOORJ02702	0445120062 0445120289 0445120224 0445120309 0445120227 0445120310 0445120232 0445120343 0445120242 0445120357 0445120247 0445120391 0445120262 0445120265 0445120266 0445120277			

序号 NO.	型号 Model	适用喷油器型号 Suitable for Injector Model	产地 Place of Origin	产品图片 Product pictures	备注 Remarks
9	HD110701电装	095000-5471 095000-6700 095000-8010 095000-6353 095000-6691 095000-6701 095000-5215			
10	HD110702电装	适用于电装5550喷油器上			
11	HD110704电装 (电感：165uH)	095000-6790 095000-6222 095000-5600 095000-6791 095000-8100 095000-6250 095000-7761			
12	HD110705电装 (电感：270uH)	适用于电装0L050喷油器上			

序号 NO.	型号 Model	适用喷油器型号 Suitable for Injector Model	产地 Place of Origin	产品图片 Product pictures	备注 Remarks
13	康明斯电磁阀2697				
14	电装电磁阀5600				
15	卡特320D电磁阀				
16	南岳单体泵电磁阀 NDB100A-04				

序号 NO.	型号 Model	适用喷油器型号 Suitable for Injector Model	产地 Place of Origin	产品图片 Product pictures	备注 Remarks
17	120系列电极隔板	FOORJ02703 FOORJ02697			



# 东港威远油泵油嘴有限公司

DONG GANG WEI YUAN FUEL INJECTION EQUIPMENT CO.,LTD.  
Imported Solenoid & Sensor Catalogue

序号 NO.	型号 Model	产地 Place of Origin	备注 Remarks
1	AEPD01	USA	
产品图片 pictures			
<b>适用喷油器型号 Suitable for Injector Model</b>			
Suitable for injectors Delphi, Caterpillar, Perkins, Komatsu, Volvo. <b>DELPHI</b> Delphi 3406E Injectors: EX630956 / 10R0956 - 14.6L/15.8L EX630957 / 10R0957 - 14.6L/15.8L EX630958 / 10R0958 - 14.6L/15.8L Delphi C10/C12 Injectors: EX630725 / 10R0725, 212-3464 - C10/C12/3176C/3196 EX630961 / 10R0961, 212-3465, 116-5426 - C10/3176C EX630963 / 10R0963, 212-3465, 137-2500, 147-0373, EX630967 / 10R0967, 161-1785, 116-5414, 212-3462 - C10/3176C 160-1090, 160-2303, 194-5083, 212-3463 - C12/3196 EX630968 / 10R0698, 116-5425, 156-1011, 212-3466 - C12/3196 Delphi C13 Injectors: EX632977 / 10R2977, 249-0708 <b>CATERPILLAR</b> Caterpillar 3406E Reman Fuel Injector 10R0956, 10R0957, 10R0958 Caterpillar C10, C12 Reman Fuel Injector 10R0725 Caterpillar C15, C16 Reman Fuel Injector 10R1000 Caterpillar C15, 3406 Reman Fuel Injector 10R1273 Caterpillar C15, C16, 3406 Reman Fuel Injector 10R0955, 10R0956 <b>PERKINS</b> Perkins Marino CH10948 serie 2800 Perkins injector 2645A749 - 1106C <b>KOMATSU</b> Komatsu Excavator Fuel Injector, D65EX-17 Injector, D85PX-15, D85EX-15, D85EX-15SL, D155AX-7, D155AX-7, D275AX-5, D275AX-5SL, D475A-5, D375A-6, D475A-5SD, D65E-12, D65P-12 WD600-3, D375A-6, D375A-5, D31EX-22, D31PX-22, D37EX-23, D39EX-23. <b>DELPHI / VOLVO</b> Delphi EUI D12 Injectors:		EX631002 / 12.1L, X-reference: Volvo 15479098112557 EX631004 / 12.1L, X-reference: Volvo 39644048113092 EX631006 / 12.1L, X-reference: Volvo 81131808170966 EX631007 / 12.1L, X-reference: Volvo 31695218113837 Other injectors and information: Delphi 7135-486, Delphi BEBE4B12004 / 8112557 Caterpillar series 3500; 3500E / 3508E 3512E / 3516E, 3500 Marine MUI Perkins 3176 Volvo1547909 / 3155040 Solenoid type : CAT C10, CAT C12, CAT C13, CAT C15, CAT C16, 3406E Delphi, Caterpillar, Perkins, Komatsu, Volvo	





序号 NO.	型号 Model	产地 Place of Origin	备注 Remarks
2	AEPD18 ( 0810 )	USA	
产品图片 pictures			
适用喷油器型号 Suitable for Injector Model			
Suitable for injectors (REDAT +OEM) CATERPILLAR 1 212 656 redat		Injectors suitable list CATERPILLAR Marine Applications Solenoid type CATERPILLAR Marine Pump CATERPILLAR C9.3, 1 212 656 redat	

序号 NO.	型号 Model	产地 Place of Origin	备注 Remarks
3	WYW-DCF-PYQ-320D(AP)	USA	
产品图片 pictures			
适用喷油器型号 Suitable for Injector Model			
Suitable for injectors (REDAT +OEM) CATERPILLAR C6.6 326-4700, 32F61-00060, 32F61-00062 095000-320D, 2645A745, 2645A747, 10R-7675 Injectors suitable list CATERPILLAR C6.6 Common Rail Solenoid type CATERPILLAR C6.6 Complementary information : Solenoide Common Rail 320D / 323D, Caterpillar 326-4700 for 320D / 323D Ref. Injector : CAT320D, 3264700, *C4.2 and C6.4 Engines OEM NO : 326 4700, Brand Name: CAT, Model Number: 326 4700		CATERPILLAR C6.6	

序号 NO.	型号 Model	产地 Place of Origin	备注 Remarks
4	AEPD20 ( 0482 )	USA	
产品图片 pictures			
适用喷油器型号 Suitable for Injector Model			
Injector Solenoid CAT 3408 / 3412 Suitable for injectors : Caterpillar Diesel 3408 Caterpillar Diesel 3412 Engine # 3408/3412 CAT # 206-1217, 10R0969		CAT 3408/3412 CAT #206-1217,10R0969 CATERPILLAR	

序号 NO.	型号 Model	产地 Place of Origin	备注 Remarks
5	AEP_SO23	USA	
产品图片 pictures			
适用喷油器型号 Suitable for Injector Model			
Suitable for injectors: Cummins N14, Cummins L10, Cummins M11  Solenoid type : Cummins N14, L10, M11 CUMMINS			

序号 NO.	型号 Model	产地 Place of Origin	备注 Remarks
6	2145427	USA	
产品图片 pictures			
适用喷油器型号 Suitable for Injector Model			
<p>Suitable for injectors :</p> <p>Delphi, Caterpillar.</p> <p>DELPHI Delphi C7 Injectors: EX634761 / 10R4761 - 222-5959, 222-5961, 233-5636, 236-0973, 241-3238, 243-4502, 295-1408, 328-2583, 387-9430. EX634762 / 10R4762 - 222-5962, 238-9808, 238-9809, 241-3239, 243-4503, 295-1409, 328-2584, 387-9429. EX634763 / 10R4763 - 222-5958, 231-3400, 233-3535, 236-0974, 238-8091, 241-3400, 246-2343, 295-1410, 328-2582, 387-9428.</p> <p>Caterpillar</p> <p>CAT Injector 10R4763 - CAT C7 Engines CAT Injector 10R4761 - CAT C7/C9 CAT Injector 10R4762 - CAT C7 Engines / 10R4762R, 10R-4762R</p> <p>Other injectors and information: (REDAT +OEM) CAT C7 : 238-8091, 241-3239, CAT C9 254-4339, CAT C9 263-8218, 328-2582, 387-9427, 10R-4761, 10R-4762, 10R-4763. CAT C9 : 235-288, 236-0962</p> <p>Injectors suitable list :</p> <p>Caterpillar C7 : 238-8091, 241-3239 Caterpillar C9 : 254-4339 Caterpillar C9 : 263-8218, 328-2582, 387-9427, 10R-4761, 10R-4762, 10R-4763. Caterpillar C9 : 235-288, 236-0962</p> <p>Solenoid type : CAT C7, CAT C9. CATERPILLAR</p>			

序号 NO.	型号 Model	产地 Place of Origin	备注 Remarks
7	128-6601	USA	
产品图片 pictures			
适用喷油器型号 Suitable for Injector Model			
<p>Suitable for injectors:            Ford Powerstroke 7.3L / Navistar HEUI DT466, I530E, DT466 / 530, HT530            Ford 7.3L Powerstroke: AP63800AA, AP63801AB.            Navistar DT466E: AP63805BA, AP63806BB, AP63807BC, AP63808BD, AP63809BE, AP63810BF.            CAT 3126B/E HEUI</p>			

序号 NO.	型号 Model	产地 Place of Origin	备注 Remarks
8	AEP_SO4	USA	
产品图片 pictures			
适用喷油器型号 Suitable for Injector Model			
<p>Suitable for injectors :</p> <p>Ford Powerstroke 7.3L (Blue connector)</p> <p>PurePower: 7002-PP, 7003-PP.            Alliant Power: AP63803AD, AP63804AE.            CAT HEUI</p>			

序号 NO.	型号 Model	产地 Place of Origin	备注 Remarks
9	AEP_SO5	USA	
产品图片 pictures			
适用喷油器型号 Suitable for Injector Model			
<p>Solenoid for CAT GP FUEL INJECTOR NEW 3524B ENGINE, New product !!  Suitable for engine/ Compatible con maquina / Compatible avec:  CAT 3524B</p> <p>Injectors suitable list / Lista de inyectores compatibles / Liste d'injecteurs compatibles:</p> <p>Caterpillar c9 engine  CAT: 363-0489 gp-fuel injector  CAT: 339-5599 pump gp-fuel injection  Caterpillar C175 engine for mining truck  CAT: 340-6996  Caterpillar 331-5895 gp-fuel injector  CAT: 797B, 3524B, C175-16/20</p> <p>Injector Specifications:  Heavy Duty / Mining Truck, Model : 3524 B, MPN : 331-5895  Brand : Caterpillar</p> <p>Solenoid type / Bobina, solenoide tipo / Solenoïde type:  CAT 3524B, C9, C175  C9, 797B, 3524B, C175-16/20  CAT 363-0489, 340-6996, 331-5895, 339-5599 pump</p>			

序号 NO.	型号 Model	产地 Place of Origin	备注 Remarks
10	AEP_SO6	USA	
产品图片 pictures			
适用喷油器型号 Suitable for Injector Model			
<p>Suitable for injectors / Compatible con inyectores / Compatible avec:            FORD Powerstroke 6.0L / 4.5L            AP60800, 1843481C94, 1846692C92</p> <p>Injectors suitable list / Lista de inyectores compatibles / Liste d'injecteurs compatibles:            FORD Powerstroke 6.0L / 4.5L</p> <p>Solenoid type / Bobina, solenoide tipo / Solenoïde type:            Powerstroke G2.8 / 6.0L &amp; 4.5L</p> <p>Complementary information / Informacion complementaria / Information            complementaire:            OEM Part Numbers:            1844751C2, 1845150C92, 1846692C92, 1877748C1, 1878284C91, 1878285C91,            1879998C91            Application : VT365, VT275, MaxxForce 5            Year Range : 2002 1/2-2003, 2004-2006, 2006, 2007-2010            Alliant Power : DT466 / 570, HT570</p>			

序号 NO.	型号 Model	产地 Place of Origin	备注 Remarks
11	312-5620	USA	
产品图片 pictures			
适用喷油器型号 Suitable for Injector Model			
Suitable with : CATERPILLAR Pump / MITSUBISHI (w/o seat for the O'ring) Injectors suitable list : CATERPILLAR Pump C6.6 Solenoid type : CATERPILLAR Pump C6.6 Complementary information : *C4.2 and C6.4 Engines		Application: PERKINS / CAT 1106 CATERPILLAR 291-5919 - 2P007695, Common Rail Pump C6.6 CAT PART NO : 3178021 / CAT 291-5919 - 2P007695 CAT 295-9125 PERKINS PART NO : 2641A312 Perkins Pump series 1100	

序号 NO.	型号 Model	产地 Place of Origin	备注 Remarks
12	312-5620HC	USA	
产品图片 pictures			
适用喷油器型号 Suitable for Injector Model			
Suitable with : CATERPILLAR Pump / MITSUBISHI (w/o seat for the O'ring) Injectors suitable list : CATERPILLAR Pump C6.6 Solenoid type : CATERPILLAR Pump C6.6 Complementary information : *C4.2 and C6.4 Engines		Application: PERKINS / CAT 1106 CATERPILLAR 291-5919 - 2P007695, Common Rail Pump C6.6 CAT PART NO : 3178021 / CAT 291-5919 - 2P007695 CAT 295-9125 PERKINS PART NO : 2641A312 Perkins Pump series 1100	

序号 NO.	型号 Model	产地 Place of Origin	备注 Remarks
13	AEP_SO9	USA	
产品图片 pictures			
适用喷油器型号 Suitable for Injector Model			
<p>Suitable for injectors :</p> <p>Maxxforce G2.9 Injectors AP66977, 1842577C93</p> <p>Injectors suitable list :</p> <p>NAVISTAR International Maxxforce G2.9 - 9/10</p> <p>VT 365/6.0L International 2002-5-2003 - 4100 @ 230HP - 4200 @ 175-200 And 215HP - 3200 Bus @ 175-200 and 215 HP - 3300 BUS @ 175HP 6.0L dit FORD Powerstroke 2003-2004 - F250/F550 Excursion s/n up to 137-745 1843089C91, 1845879C91, 1843481C94, 1843481C95, 3C3Z-9E527-AE, 3C3Z-9E527-ABRM</p> <p>6.0L dit FORD Powerstroke 2004-2006 - F250/F550 Excursion - F650/F750 - dit FORD</p> <p>Powerstroke 2006 - LCF VT 365/6.0L International 2004-2006 - 4100 @ 230 HP - 4200 @ 175-200-215 and 230HP - 3200 bus @ 175-200 AND 215 HP - 3300 bus @ 175 HP VT 275/4.5L International 2006E Series 4.5L 1843089C91, 1845879C91, 1843481C94, 1843481C95, 3C3Z-9E527-AE, 3C3Z-9E527-ABRM</p> <p>Solenoid type :</p> <p>NAVISTAR International Maxxforce G2.9</p> <p>Complementary information :</p> <p>Ref. Inyector :</p> <p>AP66992, AP66995 (2006) AP66855, AP66857, AP66858 (2010-2013) G2.9 (2004-2010) Alliant Power - MaxxForce 9 &amp; 10, DT466 / 570, HT570, Maxxforce DT / 9/10</p> <p>Maxxforce G2.9 Injectors AP66977, 1842577C93, NAVISTAR International Maxxforce G2.9 - 9/10,</p>			



序号 NO.	型号 Model	产地 Place of Origin	备注 Remarks
14	AEP_SO8	USA	
产品图片 pictures			
适用喷油器型号 Suitable for Injector Model			
<p>Suitable for injectors :</p> <p>CAT C15 ACERT E4 / C13</p> <p>CAT C15 4 Pins EUI</p> <p>CAT C13 Engine 349E L Excavator</p>			



# 东港威远油泵油嘴有限公司

DONG GANG WEI YUAN FUEL INJECTION EQUIPMENT CO.,LTD.

## Repair Tools

序号 NO.	型号 Model	适用喷油器型号 Suitable for Injector Model	产地 Place of Origin	备注 Remarks
1	WY-38CR		china	
产品图片 pictures				
内含Inclusion:				
<p>38件套电控喷油器分解工具（扭力扳手选配 订货代号：WY-38CR）</p> <p>38 sets of electronic control fuel injector decomposition tools (Torsion wrench needs selected. TYPE NO: WY-38CR)</p> <p>电磁阀紧座套筒扳 Solenoid valve seat sleeve wrench</p> <p>油嘴紧帽套筒扳手 Oil nozzle cap sleeve wrench</p> <p>油封装配器 Oil-encapsulated fittings</p> <p>阀组件顶丝 Valve assembly top wire</p> <p>阀组件安装工具 Valve Assembly Installation Tool</p> <p>阀组件螺母拆卸工具 Valve assembly nut disassembly tool</p> <p>卡特彼勒十字扳手 Caterpillar Cross Spanner</p> <p>油封取出器 Oil Seal Remover</p>				

序号 NO.	型号 Model	适用喷油器型号 Suitable for Injector Model	产地 Place of Origin	备注 Remarks
2	WY-23CR		china	
产品图片 pictures				
内含Inclusion:				
<p>23件套电控喷油器分解工具（扭力扳手选配 包含简易拆装架 订货代号：WY-23CR） 23 sets of electronically controlled fuel injector decomposition tools (Torsion wrench selection includes simple disassembly rack TYPE NO: WY-23CR)</p> <p>电磁阀紧座套筒扳手Solenoid valve seat sleeve wrench            阀组件螺母拆卸工具Valve assembly nut disassembly tool            油嘴紧帽套筒扳手Oil nozzle cap sleeve wrench            电装三爪扳手Electrically fitted three-claw spanner            小松扳手Komatsu wrench            卡特彼勒十字扳手Caterpillar Cross Spanner            油封取出器Oil Seal Remover            油封装配器Oil-encapsulated fittings            简易喷油器拆装架等Simple fuel injector disassembly rack, etc.</p>				

序号 NO.	型号 Model	适用喷油器型号 Suitable for Injector Model	产地 Place of Origin	备注 Remarks
3	WY-NC011		china	

产品图片  
pictures



### Adaptation Model Table:

电控喷油器夹持器（12件套）货号:WY-NC011

Electronically Controlled Injector Holder (12 sets)TYPE NO:WY-NC011

套件均附带各型号O型圈、进油接头、紧帽、密封套

All kits are equipped with O-rings, oil inlet joints, tight caps and sealing sleeves of various types.

代号 (Item)	规格 (Specifications)	适配机型 (Suitable injector)
D70	Zφ26	BOSCH 0445 120 156 0445 120 083 0445 120 110 0445 B2910 300
D71	Yφ26-φ19	DENSO 6222 5942 5941 6692
D72	Yφ26	BOSCH 0445 120 123 0445 120 007 0445 120 059 0445 120 078 (0455 120 121 0455 120 070 加密封套)
D73A	Zφ30	BOSCH 0445 120 127 0445 120 086 265
D74A	Yφ30	BOSCH
D75	Zφ28	BOSCH 0445 120 160 0445B29029 0445 120 215 0445 B2900 600
D76	Yφ28	BOSCH 0445 120 124
D77	Zφ29	BOSCH
D77B	Yφ29	BOSCH 0445 120 102
D78	Zφ32	BOSCH 0445 120 106 084
D78B	Yφ32	BOSCH RENAULT
D79	Zφ34	BOSCH

序号 NO.	型号 Model	适用喷油器型号 Suitable for Injector Model	产地 Place of Origin	备注 Remarks
4	WY-NC012		china	
产品图片 pictures				
<p>短距夹持器 (12件套 订货代号 WY-NC012) Short Distance Holder (12 sets of TYPE NO:WY-NC012)</p>				

序号 NO.	型号 Model	适用喷油器型号 Suitable for Injector Model	产地 Place of Origin	备注 Remarks
5	WY-BPZ01	卡特3126 C7 C9 C-9泵喷嘴拆装	china	
产品图片 pictures				
<p>卡特中压共轨喷油器拆装工具 (订货代号: <b>WY-BPZ01</b>) Carter Medium Pressure Common Rail Injector Disassembly Tool (TYPE NO: WY-BPZ01)</p> <p>适用于: 卡特3126 C7 C9 C-9泵喷嘴拆装 Suitable for: Carter 3126 C7 C9 C-9 pump nozzle disassembly and assembly</p>				

序号 NO.	型号 Model	适用喷油器型号 Suitable for Injector Model	产地 Place of Origin	备注 Remarks
6	WY-BPZ02		china	
产品图片 pictures				
<p>康明斯喷油器拆装工具（订货代号：WY-BPZ02） Cummins Injector Disassembly Tool (TYPE NO: WY-BPZ02)</p>				

序号 NO.	型号 Model	适用喷油器型号 Suitable for Injector Model	产地 Place of Origin	备注 Remarks
7	WY-BPZ03		china	
产品图片 pictures				
<p>沃尔沃喷油器拆装工具（订货代号：WY-BPZ03） Volvo Injector Disassembly Tools (TYPE NO: WY-BPZ03)</p>				

序号 NO.	型号 Model	适用喷油器型号 Suitable for Injector Model	产地 Place of Origin	备注 Remarks
8	WY-NC003	BOSCH、DENSO	china	
产品图片 pictures				
<p>共轨喷油器滤芯拆装工具（订货代号：WY-NC003） Common rail injector filter element disassembly tool (TYPE NO: WY-NC003)</p>				

序号 NO.	型号 Model	适用喷油器型号 Suitable for Injector Model	产地 Place of Origin	备注 Remarks
9	WY-NC002		china	
产品图片 pictures				
<p>HP0柱塞修复工具（订货代号：WY-NC002） HP0 plunger repair tool (TYPE NO: WY-NC002)</p>				

序号 NO.	型号 Model	适用喷油器型号 Suitable for Injector Model	产地 Place of Origin	备注 Remarks
10	WY-JY05		china	
产品图片 pictures				
<p>共轨喷油器回油接头套件 (订货代号: WY-JY05) Common rail injector return joint kit (TYPE NO: WY-JY05)</p>				

序号 NO.	型号 Model	适用喷油器型号 Suitable for Injector Model	产地 Place of Origin	备注 Remarks
11	WY-F02B		china	
产品图片 pictures				
<p>博世617燃油计量阀拉马 (订货代号: WY-F02B) Bosch 617 Fuel Metering Valve Lama (TYPE NO: WY-F02B)</p>				



序号 NO.	型号 Model	适用喷油器型号 Suitable for Injector Model	产地 Place of Origin	备注 Remarks
12	WY-F02A		china	
产品图片 pictures				
<p>博世818燃油计量阀拉马 (订货代号: WY-F02A) Bosch 818 fuel metering valve Lama (TYPE NO: WY-F02A)</p>				

序号 NO.	型号 Model	适用喷油器型号 Suitable for Injector Model	产地 Place of Origin	备注 Remarks
13	WY-F01A		china	
产品图片 pictures				
<p>德尔福燃油计量阀拉马 (订货代号: WY-F01A) Delphi Fuel Metering Valve Lama (TYPE NO: WY-F01A)</p>				

序号 NO.	型号 Model	适用喷油器型号 Suitable for Injector Model	产地 Place of Origin	备注 Remarks
14	WY-WD01		china	
产品图片 pictures				

万能夹持器 (订货代号: WY-WD01)  
 Universal gripper (TYPE NO: WY-WD01)

序号 NO.	型号 Model	适用喷油器型号 Suitable for Injector Model	产地 Place of Origin	备注 Remarks
15			china	
产品图片 pictures				

电控高压泵分解工具

Electronically Controlled High Pressure Pump Decomposition Tool

### 适配机型 (Part Number)

**DENSO – U2柱塞拆装固定座**

DENSO-fixing seat for disassembling u2 plunger

**BOSCH – CP3 保持器 (改进型可拆卸CP3全系油泵)**

BOSCH-CP3 Retainer

**DENSO – U2 柱塞弹簧压器**

DENSO-used for pressing plunger spring of-u2 pump

**BOSCH – 输油泵定位工具**

BOSCH-fixing tools for supply pump

**BOSCH-CP2 保持器**

BOSCH-CP2 Retainer

**BOSCH – 油泵油封拉马**

BOSCH-puller for the oil seal of the pumps

**DENSO – U2 出油阀紧座扳手 (S42)**

DENSO-wrench for U2delivery valve(S42)

**1/2" 标准弯杆扳手**

1/2"standard curved wrench

T20

T30

T40

T50

序号 NO.	型号 Model	适用喷油器型号 Suitable for Injector Model	产地 Place of Origin	备注 Remarks
16	WY-CZJ02		china	
产品图片 pictures				
<p>虎钳式拆装架（订货代号：WY-CZJ02） clamp disassembly rack (TYPE NO: WY-CZJ02)</p>				

序号 NO.	型号 Model	适用喷油器型号 Suitable for Injector Model	产地 Place of Origin	备注 Remarks
17	Upgrade WY-CZJ02		china	
产品图片 pictures				
<p>翻转式虎钳式拆装架升级款（升级款WY-CZJ02） Upgrade of Flipping Gear Disassembly Frame (Upgrade WY-CZJ02)</p>				

序号 NO.	型号 Model	适用喷油器型号 Suitable for Injector Model	产地 Place of Origin	备注 Remarks
18	WY-CZJ03		china	
产品图片 pictures				
<p>WY-CZJ03可翻转式拆装架 WY-CZJ03 reversible disassembly frame</p> <p>翻转式喷油器拆装架（订货代号：WY-CZJ03） Reversible Injector Disassembly Frame (TYPE NO: WY-CZJ03)</p>				

序号 NO.	型号 Model	适用喷油器型号 Suitable for Injector Model	产地 Place of Origin	备注 Remarks
19	WY-CZJ04		china	
产品图片 pictures				
<p>WY-CZJ04泵喷嘴专用拆装架 Special disassembly frame for nozzle of WY-CZJ04 pump</p> <p>泵喷嘴专用拆装架（订货代号：WY-CZJ04） Special disassembly rack for pump nozzle (TYPE NO: WY-CZJ04)</p>				

序号 NO.	型号 Model	适用喷油器型号 Suitable for Injector Model	产地 Place of Origin	备注 Remarks
20	WY-DZ30/DZ31		china	
产品图片 pictures				

卡特中压共轨适配器 (订货代号:WY-DZ30/DZ31)  
Carter medium voltage common rail adapter (TYPE NO: WY-DZ30/DZ31)

中压共轨适配器  
Medium pressure common rail adaptor

货号 Model No.	适配 Applied for
DZ30	CATERPILLAR C7 HEUI CATERPILLAR C9 HEUI
DZ31	CATERPILLAR 318 HEUI

序号 NO.	型号 Model	适用喷油器型号 Suitable for Injector Model	产地 Place of Origin	备注 Remarks
21	WY-H10		china	
产品图片 pictures		 <p>H10回油装置(订货代号:H10) 适用于:电装小松挖掘机喷油器 H10 backflow kit(Order code:H10) For DENSO injectors(on komatsu excvator)</p>		

电装小松回油装置 (订货代号: WY-H10)  
Electric Komatsu Oil Return Device (TYPE NO: WY-H10)

序号 NO.	型号 Model	适用喷油器型号 Suitable for Injector Model	产地 Place of Origin	备注 Remarks
22	WY-H20		china	
产品图片 pictures		 <p>H20回油装置(订货代号:H20) 适用于卡特彼勒喷油器 H20 backflow kit(Order code:H20) For caterpillar injectors</p>		
<p>卡特彼勒回油装置、卡特320D夹具 (订货代号: WY-H20) Caterpillar oil return unit and Caterpillar 320D fixture (TYPE NO: WY-H20)</p>				

序号 NO.	型号 Model	适用喷油器型号 Suitable for Injector Model	产地 Place of Origin	备注 Remarks
23	WY-JY04A/B	所有型号	china	
产品图片 pictures				
<p>简易集油器改进版 Simple Oil Collector Improvement Edition</p> <div style="border: 1px solid black; padding: 5px;"> <p><b>简易集油器改进版</b> Upgraded version of the last fuel collector</p> <ul style="list-style-type: none"> <li>• 全铜件制造 Made of copper</li> <li>• 加大油封 Enlarged oil seal</li> <li>• 高强度螺栓固定 High strength screw to fix</li> </ul> <p>订货代号: JY04A/B 支持所有型号喷油器 Apply to all fuel injectors</p> </div>				

序号 NO.	型号 Model	适用喷油器型号 Suitable for Injector Model	产地 Place of Origin	备注 Remarks
24	WY-JY/03	所有BOSCH型号	china	
产品图片 pictures		<p>BOSCH集油器(订货代号:WY/03) BOSCH fuel collector (Order code: WY/03) 支持博世所有型号喷油器 Apply to all fuel injectors of BOSCH</p>		
<p>BOSCH集油器支持博世所有型号 (订货代号: WY-JY/03) BOSCH collector supports all Bosch models (TYPE NO: WY- JY/03)</p>				

序号 NO.	型号 Model	适用喷油器型号 Suitable for Injector Model	产地 Place of Origin	备注 Remarks
25	WY-JY02A/02B	所有c7/c9油嘴喷油器	china	
产品图片 pictures		<p>快速集油器 Fast fuel collector</p> <p>连接快速—方便牢固 平头大油封封油—永不渗漏 支持市面全部喷油器 Fast connection—convenient and firm Plane big oil seal—no leakage Apply to all fuel injectors in the market</p> <p>订货代号: JY02A 适配所有07油嘴喷油器 (Order code: WY02A) Apply to all injectors with 07 nozzles</p> <p>订货代号: JY02B 适配所有09油嘴喷油器 (Order code: WY02B) Apply to all injectors with 09 nozzles</p>		
<p>快速集油器适配所有c7/c9油嘴喷油器 (订货代号: WY-JY02A/02B) Fast collector adapts to all c7/c9 nozzle injectors (TYPE NO: WY- JY02A/02B)</p>				



序号 NO.	型号 Model	适用喷油器型号 Suitable for Injector Model	产地 Place of Origin	备注 Remarks
26			china	
<p>产品图片 pictures</p>				
<p>喷油器车拆工具 Injector Dismantling Tool 车拆工具配带接头 Car disassembly tool fittings</p>				

序号 NO.	型号 Model	适用喷油器型号 Suitable for Injector Model	产地 Place of Origin	备注 Remarks
27	0445 120系列套装 0445 120 series suits		china	
产品图片 pictures				
包含：Contain:				
<p>喷油器高精度调整垫片： High Precision Adjustment Gaskets for Injector</p> <p>0445 120系列套装（500片）：0445 120 series suits (500 pieces)</p> <p>B13 电磁铁弹簧调整垫片（弹簧力调整垫片）常用等级100片 B13 Electromagnet Spring Adjustment Gasket (Spring Force Adjustment Gasket) Common Grade 100</p> <p>B14 油嘴调压垫片（怠速调整垫片）常用等级100片 B14 Oil Nozzle Pressure Regulating Gasket (Idle Speed Regulating Gasket) Commonly Used Grade 100</p> <p>B16 油嘴针阀升程垫片（实心垫片）常用等级100片 B16 Needle Valve Lift Gasket (Solid Gasket) Common Class 100</p> <p>B22 缓冲行程垫骗（过升程调整垫片）常用等级100片 B22 cushion stroke cushion swindle (over-lift adjustment gasket) 100 commonly used grades</p> <p>B26 衔铁升程垫片（大车衔铁垫片）常用等级100片 B26 armature lift gasket (armature gasket for big car) 100 pieces of commonly used grade</p>				

序号 NO.	型号 Model	适用喷油器型号 Suitable for Injector Model	产地 Place of Origin	备注 Remarks
28	0445 110系列套装 0445 110 series suits		china	
产品图片 pictures				
包含: Contain:				
<p>0445 110系列套装 (500片) : 0445 110 series suits (500 pieces)</p> <p>B13 电磁铁弹簧调整垫片 (弹簧力调整垫片) 常用等级100片 B13 Electromagnet Spring Adjustment Gasket (Spring Force Adjustment Gasket) Common Grade 100</p> <p>B14 油嘴调压垫片 (怠速调整垫片) 常用等级100片 B14 Oil Nozzle Pressure Regulating Gasket (Idle Speed Regulating Gasket) Commonly Used Grade 100</p> <p>B25 气隙调整垫片 (电磁阀调整垫片) 常用等级100片 B25 air gap adjusting gasket (solenoid valve adjusting gasket) Common Grade 100</p> <p>B31 阀座调整垫片 常用等级100片 B31 Seat Adjustment Gasket Common Class 100</p> <p>B37 电磁铁弹簧调整垫片 常用等级100片 B37 Electromagnet Spring Adjustment Gasket Commonly Used Grade 100</p>				

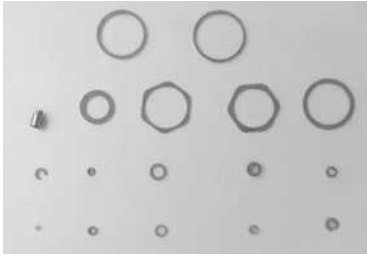
序号 NO.	型号 Model	适用喷油器型号 Suitable for Injector Model	产地 Place of Origin	备注 Remarks
29	电装垫片套装 Electrical gasket suit		china	
产品图片 pictures				

电装垫片套装 (400片) Electrical gasket suit (400 pieces)

B21常用等级100片 B21Common Grade 100

B23常用等级100片 B23Common Grade 100

B24常用等级100片 B24Common Grade 100

B27 衔铁升程调整垫片 常用等级100片

B27 armature lift adjustment gasket commonly used Grade 100 pieces

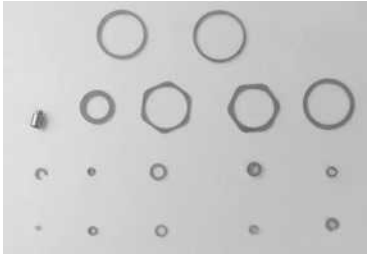
序号 NO.	型号 Model	适用喷油器型号 Suitable for Injector Model	产地 Place of Origin	备注 Remarks
30	康明斯垫片套装 Cummins Gasket Suit		china	
产品图片 pictures				

康明斯垫片套装 (500P) :

Cummins Gasket Suit (500P):

B13 电磁铁弹簧调整垫片 (弹簧力调整垫片) 常用等级100片

B13 Electromagnet Spring Adjustment Gasket (Spring Force Adjustment Gasket) Common Grade 100

B14 油嘴调压垫片 (怠速调整垫片) 常用等级100片

B14 Oil Nozzle Pressure Regulating Gasket (Idle Speed Regulating Gasket) Commonly Used Grade 100

B16 油嘴针阀升程垫片 (实心垫片) 常用等级100片

B16 Needle Valve Lift Gasket (Solid Gasket) Common Class 100

B11 气息调整垫片 (康明斯上垫) 常用等级100片

B11 breath adjustment gasket (Cummins gasket) Common Grade 100

B12 衔铁升程调整垫片 (康明斯下垫) 常用等级100片

B12 armature lift adjustment gasket (Cummins underlay) 100 pieces of commonly used grade

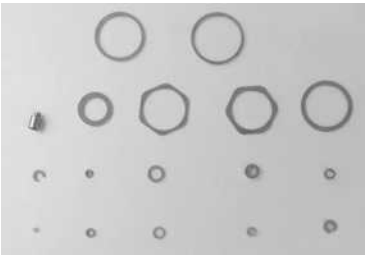
序号 NO.	型号 Model	适用喷油器型号 Suitable for Injector Model	产地 Place of Origin	备注 Remarks
31	全系列垫片小套装 Full Series Gasket Suit		china	
产品图片 pictures				

全系列垫片小套装（505片）：

Full Series Gasket Suit (505 pieces):

B13 电磁铁弹簧调整垫片（弹簧力调整垫片）常用等级50片

B13 Electromagnet Spring Adjustment Gasket (Spring Force Adjustment Gasket)  
Common Grade 50

B14 油嘴调压垫片（怠速调整垫片）常用等级50片

B14 Oil Nozzle Pressure Regulating Gasket (Idle Speed Regulating Gasket) Common  
Grade 50

B16 油嘴针阀升程垫片（实心垫片）常用等级50片

B16 Needle Valve Lift Gasket (Solid Gasket) Common Class 50

B22 阀座调整垫片（过升程调整垫片）常用等级50片

B22 Seat Adjustment Gaskets (Over-lift Adjustment Gaskets) Common Class 50

B26 衔铁升程垫片（大车衔铁垫片）常用等级50片

B26 armature lift gaskets (armature gaskets for large cars) 50 commonly used  
grades

B25 气隙调整垫片（电磁阀调整垫片）常用等级50片

B25 air gap adjusting gasket (solenoid valve adjusting gasket) commonly used  
grade 50

B31 阀座调整垫片 常用等级55片

B31 Seat Adjustment Gaskets Common Class 55

B11 气息调整垫片（康明斯上垫）常用等级50片

B11 breath adjustment gasket (Cummins gasket) commonly used grade 50

B12 衔铁升程调整垫片（康明斯下垫）常用等级50片

B12 armature lift adjusting gasket (Cummins underlay) commonly used grade 50

B27 衔铁升程调整垫片 常用等级50片

B27 armature lift adjustment gasket commonly used grade 50 pieces

序号 NO.	型号 Model	适用喷油器型号 Suitable for Injector Model	产地 Place of Origin	备注 Remarks
32	368夹具368 Fixture		china	
产品图片 pictures				
德国曼368夹具German Man 368 Fixture				

序号 NO.	型号 Model	适用喷油器型号 Suitable for Injector Model	产地 Place of Origin	备注 Remarks
33	WY-BJ02		china	
产品图片 pictures		 <p>• 电磁阀行程测量工具 (订货代号: BJ02) Metering tools for valve assembly (Order code: BJ02)</p>		
WY-BJ02测量工具 WY-BJ02 Measuring Tool				

序号 NO.	型号 Model	适用喷油器型号 Suitable for Injector Model	产地 Place of Origin	备注 Remarks
34	WY-3BJ03	Bosch、Denso	china	
产品图片 pictures				
<p>WY-BJ03测量工具（适用于博世、电装） WY-BJ03 Measuring Tool (Applicable to Bosch and Denso)</p>				

序号 NO.	型号 Model	适用喷油器型号 Suitable for Injector Model	产地 Place of Origin	备注 Remarks
35	WY-BJ04	Bosch	china	
产品图片 pictures				
<p>WY-BJ04测量工具（适用于博世） WY-BJ04 Measuring Tool (Applicable to Bosch)</p>				





序号 NO.	型号 Model	适用喷油器型号 Suitable for Injector Model	产地 Place of Origin	备注 Remarks
36	WY-XBJ04	Bosch、Denso	china	
产品图片 pictures				
<p>WY-XBJ04测量工具（适用于博世、电装） WY-XBJ04 Measuring Tool (Applicable to Bosch and Denso)</p>				

序号 NO.	型号 Model	适用喷油器型号 Suitable for Injector Model	产地 Place of Origin	备注 Remarks
37	卡特320D Cat320D		china	
产品图片 pictures				
<p>卡特320D拆装工具套装 Carter 320D disassembly Kit</p>				

序号 NO.	型号 Model	适用喷油器型号 Suitable for Injector Model	产地 Place of Origin	备注 Remarks
38			china	
产品图片 pictures				
<p>东康、福康喷油器拆装工具 Dismantling and assembling tools for Dongkang and Fukang injectors</p>				

序号 NO.	型号 Model	适用喷油器型号 Suitable for Injector Model	产地 Place of Origin	备注 Remarks
39	WY-YM02-T		china	
产品图片 pictures				
<p>WY-YM02-T阀组件研磨工具 WY-YM02-T Valve Assembly Grinding Tool转速高达2800转 Speed up to 2800 rpm</p>				

序号 NO.	型号 Model	适用喷油器型号 Suitable for Injector Model	产地 Place of Origin	备注 Remarks
40	WYW-GJ-CATB -KB-C7		china	
产品图片 pictures				
<b>C7泵拆装半圆卡板C7 SNAP-GAUGE</b>				

序号 NO.	型号 Model	适用喷油器型号 Suitable for Injector Model	产地 Place of Origin	备注 Remarks
41	WYW-CXGJ-C7/C9		china	
产品图片 pictures				
<b>C7/C9泵拆装卡板SNAP-GAUGE FOR C7 / C9 PUMP</b>				

序号 NO.	型号 Model	适用喷油器型号 Suitable for Injector Model	产地 Place of Origin	备注 Remarks
42			china	
产品图片 pictures				
<b>多功能扳手MULTI-FUNCTION WRENCH</b>				

序号 NO.	型号 Model	适用喷油器型号 Suitable for Injector Model	产地 Place of Origin	备注 Remarks
43			china	
产品图片 pictures				
C7油嘴紧帽拆装工具NOZZLE NUT ASSEMBLING AND DISASSEMBLING TOOL				

序号 NO.	型号 Model	适用喷油器型号 Suitable for Injector Model	产地 Place of Origin	备注 Remarks
44	CSD-V2		china	
产品图片 pictures				
V2油嘴适配器V2 NOZZLE TESTING TOOL				

序号 NO.	型号 Model	适用喷油器型号 Suitable for Injector Model	产地 Place of Origin	备注 Remarks
45	CSD-V4		china	
产品图片 pictures				
V4油嘴适配器V4 NOZZLE TESTING TOOL				

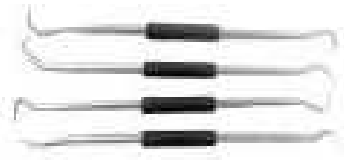
序号 NO.	型号 Model	适用喷油器型号 Suitable for Injector Model	产地 Place of Origin	备注 Remarks
46	WYW-CAT-JQGZ-C7/C9		china	
产品图片 pictures				
胶圈拆卸工具DISASSEMBLING TOOL FOR O-RING				

序号 NO.	型号 Model	适用喷油器型号 Suitable for Injector Model	产地 Place of Origin	备注 Remarks
47	CATCX-00		china	
产品图片 pictures				
卡特喷油器拆卸工具ASSAMBLING AND DISSAMBING TOOL FOR CAT				

序号 NO.	型号 Model	适用喷油器型号 Suitable for Injector Model	产地 Place of Origin	备注 Remarks
48	DZCX6-00		china	
产品图片 pictures				
电装喷油器拆卸工具ASSAMBLING AND DISSAMBING TOOL FOR DENSO				

序号 NO.	型号 Model	适用喷油器型号 Suitable for Injector Model	产地 Place of Origin	备注 Remarks
49	YDTC-QWX-01-00		china	
产品图片 pictures				

序号 NO.	型号 Model	适用喷油器型号 Suitable for Injector Model	产地 Place of Origin	备注 Remarks
50	CSD-C7/C9		china	
产品图片 pictures				

序号 NO.	型号 Model	适用喷油器型号 Suitable for Injector Model	产地 Place of Origin	备注 Remarks
51	CSD-C-9		china	
产品图片 pictures				



Web: [www.dgweiyuan.com](http://www.dgweiyuan.com)

E-mail: [webmaster@dgweiyuan.com](mailto:webmaster@dgweiyuan.com)  
[diesel@dgweiyuan.com](mailto:diesel@dgweiyuan.com)



**工厂总部**

地址: 辽宁省东港市孤山镇中大街236号

电话: 86-415-7512331

传真: 86-415-7516407

**HEAD OFFICE&FACTORT**

Add: 236# Central Street GuShan Town, DongGang,  
LiaoNing Province, 118113, China

Tel: 86-415-7512331

Fax: 86-415-7516407

**销售公司**

地址: 辽宁省沈阳市沈河区友好街19号奉天银  
座B1606室

电话: 86-24-88579578 88531517

传真: 86-24-88579568

**SALES COMPANY**

Add: Room B1606, Fengtian Yinzuo, No. 19#, Youhao Street  
Shenhe District, Shenyang, Liaoning, 110013, China

Tel: 86-24-88579578 88531517

Fax: 86-24-88579568

**沈阳工厂**

地址: 辽宁省沈阳市沈北新区蒲文路18-59号

电话: 86-24-31238192

传真: 86-24-31238191

**FACTORY IN SHENYANG**

Add: 18-59#, Puwen Road, Shenbeixin District  
Shenyang, Liaoning, 110122, China

Tel: 86-24-31238192

Fax: 86-24-31238191