

# 家具五金配件目录

## HARDWARE PARTS SUBJECT

### CONNECTING FITTING 拆装连接件 01/29

- 偏心轮系列 ..... 01-12  
Connecting Cam Fitting Series
- 连接螺杆系列 ..... 13-16  
Connection Bolt Series
- 预埋件系列 ..... 17-18  
Embedded Part Series
- 组合连接件系列 ..... 19-20  
Combined Connecting Piece Series
- 螺母系列 ..... 21-25  
Nut Series
- 螺丝系列 ..... 26-27  
Screw Series
- 装饰盖系列 ..... 28-29  
Decorative Cover Series



### SHELF BOARD SUPPORTING PIECE 层板支撑件 30/45

- 组合层板托系列 ..... 30-31  
Combined Shelf Support Series
- 塑料层板托系列 ..... 32-33  
Plastic Shelf Support Series
- 金属层板托系列 ..... 34-39  
Metal Shelf Support Series
- 固定玻璃夹系列 ..... 40-43  
Fixed Glass Clamp Series
- 活动玻璃夹系列 ..... 44  
Movable Glass Clamp Series
- 屏风夹系列 ..... 45  
Partition Clamp Series



### ACCESSORIES 小配件 46/61

- 塑料小配件系列 ..... 46-50  
Plastic Fitting Series
- 角码系列 ..... 51-54  
Angle Piece Series
- 连接件系列 ..... 55  
Connecting Piece Series
- 床配件系列 ..... 56-58  
Bed Accessory Series
- 餐台配件系列 ..... 59-60  
Dining-Table Accessory Series
- 茶几配件系列 ..... 61  
Tea Table Fitting Series



# 家具五金配件目录

## HARDWARE PARTS SUBJECT

### WARDROBE ACCESSORIES 衣柜配件 62/71

- 趟门轮系列 ..... 62-65  
Sliding-door Wheel Series
- 管座系列 ..... 66-68  
Tube Support Series
- 衣柜内部配件 ..... 69-71  
Wardrobe Internal Accessories



### CABINET ACCESSORIES 橱柜配件 72/87

- 橱柜吊码系列 ..... 72-73  
Cabinet Suspension Series
- 缓冲器系列 ..... 74  
Buffer Series
- 活动支撑杆系列 ..... 75-77  
Movable Supporting Bar Series
- 活动支架系列 ..... 78-79  
Movable Support Series
- 柜吸系列 ..... 80-82  
Counter Absorption Series
- 透气孔系列 ..... 83-84  
Ventilation Panel Series
- 地脚线系列 ..... 85  
Skirting series
- 拉手系列 ..... 86-87  
Handle Series



### OFFICE ACCESSORIES 办公配件 88/100

- 抽屉锁系列 ..... 88-90  
Drawer Lock Series
- 线盒系列 ..... 91-93  
Wire Box Series
- 鞋架&键盘系列 ..... 94  
Shoes rack & Keyboard rack Series
- 滑轨系列 ..... 95-97  
Bearing Slide Series
- 铰链系列 ..... 98-100  
Hinge Series



### GROUND SUPPORT SERIES 地下支撑系列 101/118

- 地脚钉系列 ..... 101-104  
Foot Pin Series
- 塑料脚垫系列 ..... 105  
Plastic Foot Pad Series
- 可调脚系列 ..... 106-108  
Adjustable Leg Series
- 脚轮系列 ..... 109-111  
Caster Series
- 柜脚系列 ..... 112-118  
Cabinet Leg Series



## 偏芯轮直径10/12/15/25/35毫米偏芯连接件 Ø10/12/15/25/35mm Diameter Cam and Bolt

### <LSF>中心球状家具连a

LSF连接件具有如下优势:

半圆型螺杆头从任何角度都位于偏芯轮的凹槽中央, 确保不松落, 参看左图:

1. 螺杆自动位于偏芯轮凹槽的中央合平板不再会相对于侧板而水平错置;
2. 仅旋转偏芯轮180°, 紧固距离即超过5mm;
3. 甚至不断的拆板和安装, 紧固性依然很好;
4. 反脱落的坚固连接;
5. 精密坚固, 美观的造型。

### <LSF>centric sphere connectors for furniture

LSF fittings offer definite advantages

No matter in any angle the half round connecting bolt head locates centrally in the cup-shaped cam recess, and ensure not to loose.

1. Automatic centering of the bolt means that shelves are no longer subject to lateral displacement
2. Long tightening distance of more than 5 mm by only half a turn of cam;
3. Secure tightening is guaranteed even in case of repeated disassembly and re-assembly;
4. Tight joint against loosening;
5. Delicate and elegant shape.

如图<LSF钟型示意图>所示正确的连接方法

大约5.7mm卡紧固距离(称为A)可以仅通过旋转偏芯轮半圈即可达到, 这样提供了以下优势:

1. 孔直径尺寸的偏差(+1mm到约-0.5mm)不会对效果有任何影响;
2. 在偏芯轮的箭头未到达195° 停止之前(12:30), 随着偏芯轮的旋紧, 张力即刻产生并增加。

### The<LSF Clockface>below demonstrates correct tightening

The long tightening distance A of appr:5.7 mm produced by only one half turn of the cam offers the following benefits;

1. Variations in hole size of +1mm to appr-0.5 mm do not affect using;
2. Tension is rapidly achieved as the cam is tightened, before the arrow reaches the 195° stop(12:30)

紧固距离A可分为三个行程段, 并根据功能冠以不同的名字

#### 1. 闭合距离:

0° -90° (6:00到9:00)=3.2mm行程,

这90° 的旋转使螺杆头被带入偏芯轮的中央(在这一阶段无紧固力)

#### 2. 紧固距离:

90° -165° (9:00到11:30)=1.0mm行程,

这一阶段确保了牢固的紧固力, 如果需满足特殊的钻孔尺寸, 紧固力的120° (10点)时就开始产生, 最佳紧固状态在165° 到达(11:30)。

#### 3. 双重加固距离:

165° -195° (11:30到12:15)=0.5mm行程,

该阶段仅在如下特殊情况发生:

- (1) 为满足钻孔尺寸的偏差;
- (2) 家具不断拆;
- (3) 由于过重负荷要求双重加固。

The tightening distance A can be separated into 3 segments with different functions namely:

#### 1. Closing distance:

0° -90° (6:00 to 9:00)=3.2 mm pull.

This turn draws the bolt head into the center of the center of the cam (no tightening occurs with in this segment).

#### 2. Tightening distance:

90° -165° (9:00 to 11:30)=1.0 mm pull.

This segment ensure rigid tensioning. Provided the specified drill-hole size has been met, tightening will be initiated as early as 120° (10 o'clock), Optimum security will be reached at 165° (11:30)

#### 3. Retightening distance:

165° -195° (11:30 to 12:15)=0.5 mm pull.

This segment is required only when.

- (1) To accommodate variations in drill-hole size;
- (2) If the furniture is assembled and disassembled repeatedly;
- (3) Requires retightening due to severe loading conditions.

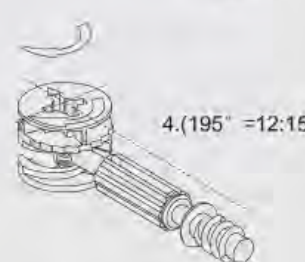
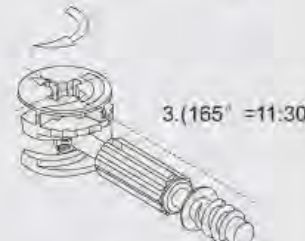
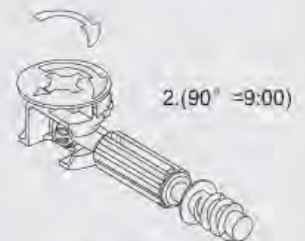
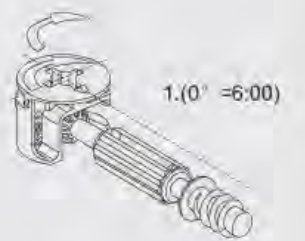
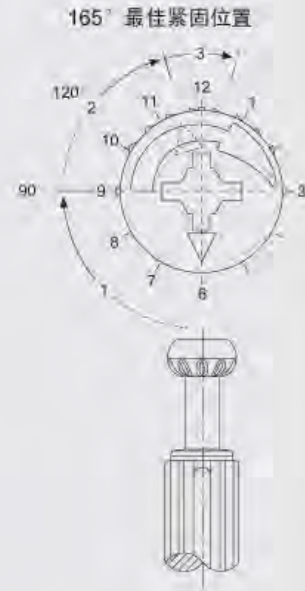

## 偏芯轮直径10/12/15/25/35毫米偏芯连接件 Ø10/12/15/25/35mm Diameter Cam and Bolt

### 安全可靠的连接件

1. 连接件位于两个锯齿的中央, 排除了家具部件之间的松动;
2. 偏芯轮的内外多层锯齿保证家具多次拆装不松动;
3. 运输过程中震动不会造成家具的松动。

### Secure and Reliable Connectors

1. Bolt positioned between teeth prevents looseness of connection;
2. Multi-layer teeth secure connection.
3. Resistant of vibration during transportaion of furniture

锌合金偏芯轮, 同必要的连接配件, 可以用以下任何一种工具锁定于12mm以上厚的木板:

Cams in zinc die-cast, for wood thicknesses above 12 mm, and matched connector, can be fixed with any of the following:

形如安装时偏芯轮应放的正确位置为偏芯轮上的箭头指向螺杆。

The cam must be installed with the arrow pointing directly towards the bolt.

例如: For example:

钻孔直径=配用的偏芯轮的直径(Ø12或Ø15mm), 详见相应偏芯轮的页面。

Drill-hole Ø=depend on housing type(Ø12 or Ø15mm), see the following Mini fix housing pages.

钻孔深度=根据不同偏芯轮高度及相配的12、15、16、18、19、22、23、26和29厚度的木板, 详见相应偏轮的页面。

Drill depth=depend. on housing type and wood thickness 12/15/16/18/19/22/23/26 and 29mm see details in ordering tables of the Mini fix house pages.

钻孔距离B=选择标准钻孔距离B19、B20、B25、B28、B32、B34, 详见相应螺杆页面。

Drilling distance B=choice between B19(19mm), B20(20mm), B24(24mm), B25(25mm), B28(mm), B32(32mm) and B34(34mm), distance between drill-hole centre to panel front edge.

钻孔直径=按配用的螺杆直径要求钻孔Ø5、Ø7、Ø8。

Bolt drill-hole Ø=drill-hole in panel edge for the connecting bolt Ø5, Ø7 or Ø8mm, according to choice of connecting bolt.

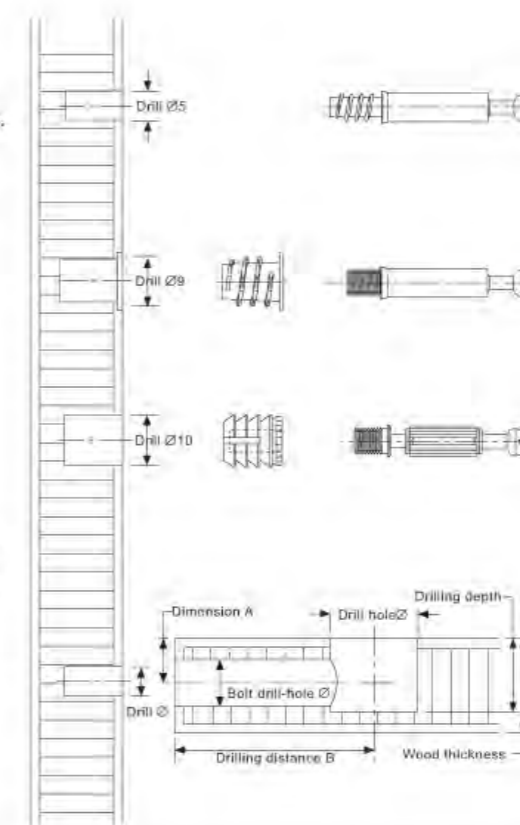
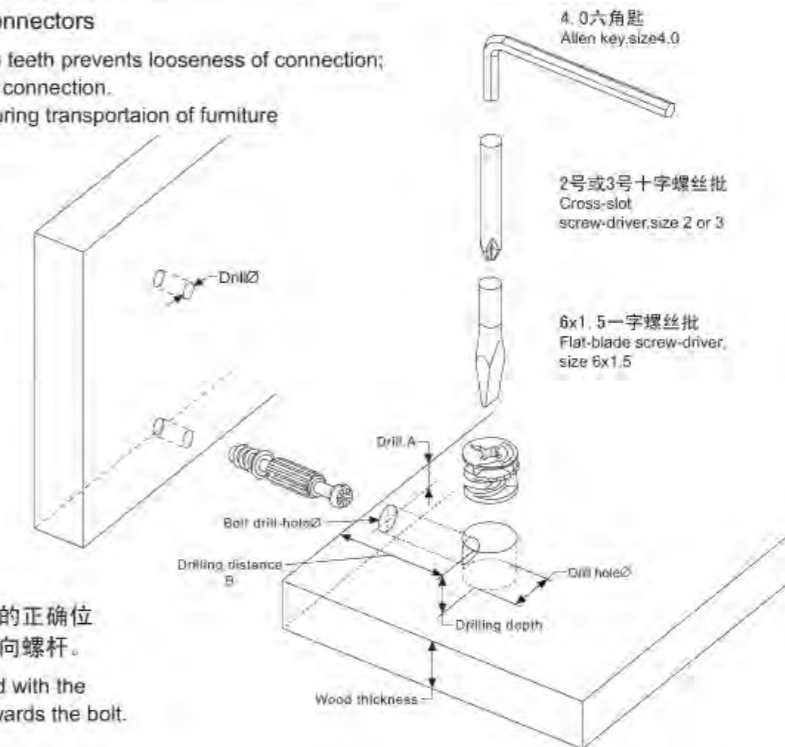

偏芯轮 规格 字母	表示
A	有牙十字头
B	有牙六角十字头
C	有牙一字头
D	无牙十字头
E	无牙六十字头





品名：偏心轮  
Name: Eccentric wheel  
主要材质：锌合金  
Material: Zinc alloy

**1518 盖**

选用板厚 For wood Thickness from	钻孔深度(H) Drilling Depth	中心孔距(Φ) Distance A Centre Locking Pos	可选用颜色 Plating
18mm	14mm	9mm	蓝锌/彩锌/黑锌/白锌/镍 Blue-zinc / Color-zinc Black-zinc/White-Zinc / Nickel



品名：偏心轮  
Name: Eccentric wheel  
主要材质：锌合金  
Material: Zinc alloy

**1518 平**

选用板厚 For wood Thickness from	钻孔深度(H) Drilling Depth	中心孔距(Φ) Distance A Centre Locking Pos	可选用颜色 Plating
18mm	14mm	9mm	蓝锌/彩锌/黑锌/白锌/镍 Blue-zinc / Color-zinc Black-zinc/White-Zinc / Nickel



品名：偏心轮  
Name: Eccentric wheel  
主要材质：锌合金  
Material: Zinc alloy

**18 星标**

选用板厚 For wood Thickness from	钻孔深度(H) Drilling Depth	中心孔距(Φ) Distance A Centre Locking Pos	可选用颜色 Plating
18mm	14mm	9mm	蓝锌/彩锌/黑锌/白锌/镍 Blue-zinc / Color-zinc Black-zinc/White-Zinc / Nickel



品名：偏心轮  
Name: Eccentric wheel  
主要材质：锌合金  
Material: Zinc alloy

**A15**

选用板厚 For wood Thickness from	钻孔深度(H) Drilling Depth	中心孔距(Φ) Distance A Centre Locking Pos	可选用颜色 Plating
18mm	14mm	9mm	蓝锌/彩锌/黑锌/白锌/镍 Blue-zinc / Color-zinc Black-zinc/White-Zinc / Nickel



品名：偏心轮  
Name: Eccentric wheel  
主要材质：锌合金  
Material: Zinc alloy

**B15**

选用板厚 For wood Thickness from	钻孔深度(H) Drilling Depth	中心孔距(Φ) Distance A Centre Locking Pos	可选用颜色 Plating
16mm	12.5mm	7.5mm	蓝锌/彩锌/黑锌/白锌/镍 Blue-zinc / Color-zinc Black-zinc/White-Zinc / Nickel



品名：偏心轮  
Name: Eccentric wheel  
主要材质：锌合金  
Material: Zinc alloy

**C15**

选用板厚 For wood Thickness from	钻孔深度(H) Drilling Depth	中心孔距(Φ) Distance A Centre Locking Pos	可选用颜色 Plating
16mm	12.5mm	7.5mm	蓝锌/彩锌/黑锌/白锌/镍 Blue-zinc / Color-zinc Black-zinc/White-Zinc / Nickel



品名：偏心轮  
Name: Eccentric wheel  
主要材质：锌合金  
Material: Zinc alloy

**D15**

选用板厚 For wood Thickness from	钻孔深度(H) Drilling Depth	中心孔距(Φ) Distance A Centre Locking Pos	可选用颜色 Plating
16mm	12.5mm	7.5mm	蓝锌/彩锌/黑锌/白锌/镍 Blue-zinc / Color-zinc Black-zinc/White-Zinc / Nickel



品名：偏心轮  
Name: Eccentric wheel  
主要材质：锌合金  
Material: Zinc alloy

**H15**

选用板厚 For wood Thickness from	钻孔深度(H) Drilling Depth	中心孔距(Φ) Distance A Centre Locking Pos	可选用颜色 Plating
16mm	12.5mm	7.5mm	蓝锌/彩锌/黑锌/白锌/镍 Blue-zinc / Color-zinc Black-zinc/White-Zinc / Nickel









品名：偏心轮  
Name: Eccentric wheel  
主要材质：锌合金  
Material: Zinc alloy

**S12**

选用板厚 For wood Thickness from	钻孔深度(H) Drilling Depth	中心孔距(φ) Distance A Centre Locking Pos	可选用颜色 Plating
12mm	10.5mm	6mm	蓝锌/彩锌/黑锌/白锌/镍 Blue-zinc / Colour-zinc Black-zinc/White-Zinc / Nickel



品名：偏心轮  
Name: Eccentric wheel  
主要材质：锌合金  
Material: Zinc alloy

**MX12平**

选用板厚 For wood Thickness from	钻孔深度(H) Drilling Depth	中心孔距(φ) Distance A Centre Locking Pos	可选用颜色 Plating
12mm	10.5mm	6mm	蓝锌/彩锌/黑锌/白锌/镍 Blue-zinc / Colour-zinc Black-zinc/White-Zinc / Nickel



品名：偏心轮  
Name: Eccentric wheel  
主要材质：锌合金  
Material: Zinc alloy

**minsmin12**

选用板厚 For wood Thickness from	钻孔深度(H) Drilling Depth	中心孔距(φ) Distance A Centre Locking Pos	可选用颜色 Plating
12mm	10.5mm	6mm	蓝锌/彩锌/黑锌/白锌/镍 Blue-zinc / Colour-zinc Black-zinc/White-Zinc / Nickel



品名：偏心轮  
Name: Eccentric wheel  
主要材质：锌合金  
Material: Zinc alloy

**MX812**

选用板厚 For wood Thickness from	钻孔深度(H) Drilling Depth	中心孔距(φ) Distance A Centre Locking Pos	可选用颜色 Plating
12mm	10.5mm	6mm	蓝锌/彩锌/黑锌/白锌/镍 Blue-zinc / Colour-zinc Black-zinc/White-Zinc / Nickel



品名：偏心轮  
Name: Eccentric wheel  
主要材质：锌合金  
Material: Zinc alloy

**823**

选用板厚 For wood Thickness from	钻孔深度(H) Drilling Depth	中心孔距(φ) Distance A Centre Locking Pos	可选用颜色 Plating
12mm	10.5mm	6mm	蓝锌/彩锌/黑锌/白锌/镍 Blue-zinc / Colour-zinc Black-zinc/White-Zinc / Nickel



品名：偏心轮  
Name: Eccentric wheel  
主要材质：锌合金  
Material: Zinc alloy

**MX10A**

选用板厚 For wood Thickness from	钻孔深度(H) Drilling Depth	中心孔距(φ) Distance A Centre Locking Pos	可选用颜色 Plating
10mm	9.5mm	5mm	蓝锌/彩锌/黑锌/白锌/镍 Blue-zinc / Colour-zinc Black-zinc/White-Zinc / Nickel



品名：偏心轮  
Name: Eccentric wheel  
主要材质：锌合金  
Material: Zinc alloy

**MX10B**

选用板厚 For wood Thickness from	钻孔深度(H) Drilling Depth	中心孔距(φ) Distance A Centre Locking Pos	可选用颜色 Plating
10mm	9.5mm	5mm	蓝锌/彩锌/黑锌/白锌/镍 Blue-zinc / Colour-zinc Black-zinc/White-Zinc / Nickel



品名：偏心轮  
Name: Eccentric wheel  
主要材质：锌合金  
Material: Zinc alloy

**1210**

选用板厚 For wood Thickness from	钻孔深度(H) Drilling Depth	中心孔距(φ) Distance A Centre Locking Pos	可选用颜色 Plating
12mm	10.5mm	6mm	蓝锌/彩锌/黑锌/白锌/镍 Blue-zinc / Colour-zinc Black-zinc/White-Zinc / Nickel



品名：偏心轮  
Name: Eccentric wheel  
主要材质：锌合金  
Material: Zinc alloy

**1213**

选用板厚 For wood Thickness from	钻孔深度(H) Drilling Depth	中心孔距(φ) Distance A Centre Locking Pos	可选用颜色 Plating
			蓝锌/彩锌/黑锌/白锌/镍 Blue-zinc / Colour-zinc Black-zinc/White-Zinc / Nickel



品名：偏心轮  
Name: Eccentric wheel  
主要材质：锌合金  
Material: Zinc alloy

**MX2512**

选用板厚 For wood Thickness from	钻孔深度(H) Drilling Depth	中心孔距(φ) Distance A Centre Locking Pos	可选用颜色 Plating
18mm	12mm	7.5mm	蓝锌/彩锌/黑锌/白锌/镍 Blue-zinc / Colour-zinc Black-zinc/White-Zinc / Nickel



品名：偏心轮  
Name: Eccentric wheel  
主要材质：锌合金  
Material: Zinc alloy

**MX1510**

选用板厚 For wood Thickness from	钻孔深度(H) Drilling Depth	中心孔距(φ) Distance A Centre Locking Pos	可选用颜色 Plating
12mm	10mm	6mm	蓝锌/彩锌/黑锌/白锌/镍 Blue-zinc / Colour-zinc Black-zinc/White-Zinc / Nickel



品名：偏心轮  
Name: Eccentric wheel  
主要材质：锌合金  
Material: Zinc alloy

**MX1500**

选用板厚 For wood Thickness from	钻孔深度(H) Drilling Depth	中心孔距(φ) Distance A Centre Locking Pos	可选用颜色 Plating
12mm	10mm	6mm	蓝锌/彩锌/黑锌/白锌/镍 Blue-zinc / Colour-zinc Black-zinc/White-Zinc / Nickel

全新纯铁  
All New Pure Iron

三合一偏心轮  
3-in-1 Eccentric Gear



**T1512A**

品名：偏心轮  
Name: Eccentric wheel  
主要材质：铁  
Material: Iron

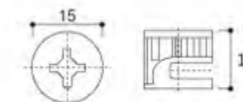

**T1512B**



**T1512C**

选用板厚 For wood Thickness from	钻孔深度(H) Drilling Depth	中心孔距(φ) Distance A Centre Locking Pos	可选用颜色 Plating
16mm	9.5mm	7.5mm	蓝锌/彩锌/黑锌/白锌/镍 Blue-zinc / Colour-zinc Black-zinc/White-Zinc / Nickel



品名：连接螺栓  
Name: Connecting bolt

**LJ017**

主要材质：铁  
Material: Iron  
表面处理：镀锌  
Finsih: Zinc

L	S	Ø	L	S	Ø
32	6.3	6	40	6.3	6
35	6.3	6			



品名：连接螺栓  
Name: Connecting bolt

**LJ018**

主要材质：铁  
Material: Iron  
表面处理：镀锌  
Finsih: Zinc

L	S	Ø	L	S	Ø
24	5.3	6	35	5.3	6
32	5.3	6	40	5.3	6



品名：连接螺栓  
Name: Connecting bolt

**LJ019**

主要材质：铁  
Material: Iron  
表面处理：镀锌  
Finsih: Zinc

L	S	Ø	L	S	Ø
35	6.3	6	45	6.3	6



品名：连接螺栓  
Name: Connecting bolt

**LJ020**

主要材质：铁  
Material: Iron  
表面处理：镀锌  
Finsih: Zinc

L	S	Ø	L	S	Ø
35	6.3	6			



品名：连接螺栓  
Name: Connecting bolt

**LJ021**

主要材质：铁  
Material: Iron  
表面处理：镀锌  
Finsih: Zinc

L	S	Ø	L	S	Ø
25	6	6	28	6	6



品名：连接螺栓  
Name: Connecting bolt

**LJ022**

主要材质：铁  
Material: Iron  
表面处理：镀锌  
Finsih: Zinc

L	S	Ø	L	S	Ø
25	5.5	6			



品名：连接螺栓  
Name: Connecting bolt

**LJ023**

主要材质：铁  
Material: Iron  
表面处理：镀锌  
Finsih: Zinc

L	S	Ø	L	S	Ø
33	6.7	6	40	6.7	6
35	6.7	6			



品名：连接螺栓  
Name: Connecting bolt

**LJ024**

主要材质：铁  
Material: Iron  
表面处理：镀锌  
Finsih: Zinc

L	S	Ø	L	S	Ø
40	6.8	6	45	6.8	6
43	6.8	6			



品名：滚花自攻三合一杆  
Name: Connecting bolt

**LJ025**

主要材质：铁  
Material: Iron  
表面处理：镀锌  
Finsih: Zinc

L	S	Ø	L	S	Ø
32	6.8	6	40	6.8	6
35	6.8	6	44	6.8	6



品名：滚花机丝三合一杆  
Name: Connecting bolt

**LJ026**

主要材质：铁  
Material: Iron  
表面处理：镀锌  
Finsih: Zinc

L	S	Ø	L	S	Ø
32	6.8	6	40	6.8	6
35	6.8	6	44	6.8	6



品名：滚花自攻三合一杆  
Name: Connecting bolt

**LJ027**

主要材质：铁  
Material: Iron  
表面处理：镀锌  
Finsih: Zinc

L	S	Ø	L	S	Ø
32	6.2	6	42	6.2	6



品名：滚花三合一螺杆  
Name: Knurled 3-In-1 Screw

**LJ028**

主要材质：铁  
Material: Iron  
表面处理：镀锌  
Finsih: Zinc

L	S	Ø	L	S	Ø
32	6.3	6	42	6.3	6
35	6.3	6	45	6.3	6



品名：双头螺杆  
Name: 2-fold screw

**LJ029**

主要材质：铁  
Material: Iron  
表面处理：镀锌  
Finsih: Zinc

L	S	Ø	L	S	Ø
54	5.5	5.2/6	72	5.5	5.2/6
60	5.5	5.2/6	74	5.5	5.2/6
64	5.5	5.2/6	78	5.5	5.2/6
68	5.5	5.2/6	80	5.5	5.2/6
70	5.5	5.2/6	84	5.5	5.2/6



品名：连接螺栓  
Name: Connecting bolt

**LJ030**

主要材质：铁  
Material: Iron  
表面处理：镀锌  
Finsih: Zinc

L	S	Ø	L	S	Ø
53		7			



品名：双折螺杆  
Name: Double-head screw

**LJ031**

主要材质：铁  
Material: Iron  
表面处理：镀锌  
Finsih: Zinc

L	S	Ø	L	S	Ø
84	42	9			



品名：连接螺栓  
Name: Connecting bolt

**LJ032**

主要材质：铁  
Material: Iron  
表面处理：镀锌  
Finsih: Zinc

L	S	Ø	L	S	Ø
52		6			





品名：连接螺栓  
Name: Connecting bolt

**LJ017**

主要材质：铁  
Material: Iron  
表面处理：镀锌  
Finsih: Zinc

L	S	Ø	L	S	Ø
32	6.3	6	40	6.3	6
35	6.3	6			



品名：连接螺栓  
Name: Connecting bolt

**LJ018**

主要材质：铁  
Material: Iron  
表面处理：镀锌  
Finsih: Zinc

L	S	Ø	L	S	Ø
24	5.3	6	35	5.3	6
32	5.3	6	40	5.3	6



品名：连接螺栓  
Name: Connecting bolt

**LJ019**

主要材质：铁  
Material: Iron  
表面处理：镀锌  
Finsih: Zinc

L	S	Ø	L	S	Ø
35	6.3	6	45	6.3	6



品名：连接螺栓  
Name: Connecting bolt

**LJ020**

主要材质：铁  
Material: Iron  
表面处理：镀锌  
Finsih: Zinc

L	S	Ø	L	S	Ø
35	6.3	6			



品名：连接螺栓  
Name: Connecting bolt

**LJ021**

主要材质：铁  
Material: Iron  
表面处理：镀锌  
Finsih: Zinc

L	S	Ø	L	S	Ø
25	6	6	28	6	6



品名：连接螺栓  
Name: Connecting bolt

**LJ022**

主要材质：铁  
Material: Iron  
表面处理：镀锌  
Finsih: Zinc

L	S	Ø	L	S	Ø
25	5.5	6			



品名：连接螺栓  
Name: Connecting bolt

**LJ023**

主要材质：铁  
Material: Iron  
表面处理：镀锌  
Finsih: Zinc

L	S	Ø	L	S	Ø
33	6.7	6	40	6.7	6
35	6.7	6			



品名：连接螺栓  
Name: Connecting bolt

**LJ024**

主要材质：铁  
Material: Iron  
表面处理：镀锌  
Finsih: Zinc

L	S	Ø	L	S	Ø
40	6.8	6	45	6.8	6
43	6.8	6			



品名：滚花自攻三合一杆  
Name: Connecting bolt

**LJ025**

主要材质：铁  
Material: Iron  
表面处理：镀锌  
Finsih: Zinc

L	S	Ø	L	S	Ø
32	6.8	6	40	6.8	6
35	6.8	6	44	6.8	6



品名：滚花机丝三合一杆  
Name: Connecting bolt

**LJ026**

主要材质：铁  
Material: Iron  
表面处理：镀锌  
Finsih: Zinc

L	S	Ø	L	S	Ø
32	6.8	6	40	6.8	6
35	6.8	6	44	6.8	6



品名：滚花自攻三合一杆  
Name: Connecting bolt

**LJ027**

主要材质：铁  
Material: Iron  
表面处理：镀锌  
Finsih: Zinc

L	S	Ø	L	S	Ø
32	6.2	6	42	6.2	6



品名：滚花三合一螺杆  
Name: Knurled 3-In-1 Screw

**LJ028**

主要材质：铁  
Material: Iron  
表面处理：镀锌  
Finsih: Zinc

L	S	Ø	L	S	Ø
32	6.3	6	42	6.3	6
35	6.3	6	45	6.3	6



品名：双头螺杆  
Name: 2-fold screw

**LJ029**

主要材质：铁  
Material: Iron  
表面处理：镀锌  
Finsih: Zinc

L	S	Ø	L	S	Ø
54	5.5	5.2/6	72	5.5	5.2/6
60	5.5	5.2/6	74	5.5	5.2/6
64	5.5	5.2/6	78	5.5	5.2/6
68	5.5	5.2/6	80	5.5	5.2/6
70	5.5	5.2/6	84	5.5	5.2/6



品名：连接螺栓  
Name: Connecting bolt

**LJ030**

主要材质：铁  
Material: Iron  
表面处理：镀锌  
Finsih: Zinc

L	S	Ø	L	S	Ø
53		7			



品名：双折螺杆  
Name: Double-head screw

**LJ031**

主要材质：铁  
Material: Iron  
表面处理：镀锌  
Finsih: Zinc

L	S	Ø	L	S	Ø
84	42	9			



品名：连接螺栓  
Name: Connecting bolt

**LJ032**

主要材质：铁  
Material: Iron  
表面处理：镀锌  
Finsih: Zinc

L	S	Ø	L	S	Ø
52		6			

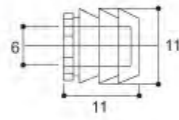

品名：三合一预埋件加厚（开口）  
Name : 3-In-1 Embedded Part  
(Extra-Thick, With Opening)

**LJ033**

主要材质：尼龙、聚乙烯  
表面处理：棕色、白色、透明  
Material : Nylon,  
Polyethylene  
Finish : Brown , White ,  
Transparent

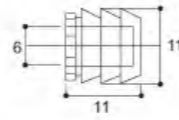

品名：三合一预埋件加厚（不开口）  
Name : 3-In-1 Embedded Part  
(Extra-Thick, Without Opening)

**LJ034**

主要材质：尼龙、聚乙烯  
表面处理：棕色、白色、透明  
Material : Nylon,  
Polyethylene  
Finish : Brown , White ,  
Transparent

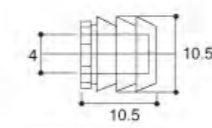

品名：10.5自攻预埋件  
Name : 10.5-Type Tapping  
Embedded Part

**LJ041**

主要材质：尼龙、聚乙烯  
表面处理：棕色、白色、透明  
Material : Nylon,  
Polyethylene  
Finish : Brown , White ,  
Transparent

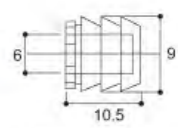

品名：6X9机丝预埋件  
Name : 6x9 Screw Embedded Part

**LJ042**

主要材质：尼龙、聚乙烯  
表面处理：棕色、白色、透明  
Material : Nylon,  
Polyethylene  
Finish : Brown , White ,  
Transparent

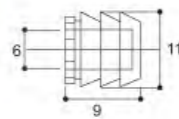

品名：8.5三合一预埋件（开口）  
Name : 8.5-Type 3-In-1 Red  
Embedded (With Opening)

**LJ035**

主要材质：尼龙、聚乙烯  
表面处理：棕色、白色、透明  
Material : Nylon,  
Polyethylene  
Finish : Brown , White ,  
Transparent

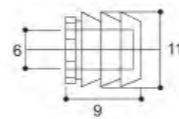

品名：8.5三合一预埋件（不开口）  
Name : 8.5-Type 3-In-1 Red  
Embedded (Without Opening)

**LJ036**

主要材质：尼龙、聚乙烯  
表面处理：棕色、白色、透明  
Material : Nylon,  
Polyethylene  
Finish : Brown , White ,  
Transparent

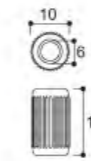

品名：双向连接螺母  
Name : Both-way connecting nut

**LJ043**

主要材质：尼龙  
表面处理：白色  
Material : Nylon  
Finish : White

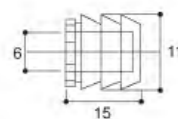

品名：双向预埋件  
Name : Two-Way Embedded Part

**LJ044**

主要材质：尼龙、聚乙烯  
表面处理：棕色、白色、透明  
Material : Nylon,  
Polyethylene  
Finish : Brown , White ,  
Transparent

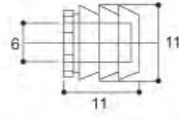

品名：高档红预埋  
Name : High-End Red Embedded

**LJ037**

主要材质：尼龙  
表面处理：棕色、白色、透明  
Material : Nylon  
Finish : Brown , White ,  
Transparent

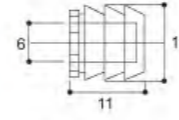

品名：高档白预埋  
Name : High-End White Embedded

**LJ038**

主要材质：尼龙  
表面处理：棕色、白色、透明  
Material : Nylon  
Finish : Brown , White ,  
Transparent

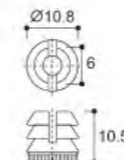

膨胀(Swell):  $\varnothing 10.8 \times 10.5 \text{mm}$

品名：10.5连体膨胀预埋件  
Name : 10.5 one-piece expansion  
embedded part

**LJ045**

主要材质：尼龙  
表面处理：白色  
Material : Nylon  
Finish : White

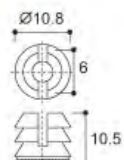

膨胀(Swell):  $\varnothing 10.8 \times 10.5 \text{mm}$

品名：10.5连体膨胀预埋件  
Name : 10.5 one-piece expansion  
embedded part

**LJ046**

主要材质：尼龙  
表面处理：白色、米黄色  
Material : Nylon  
Finish : White, Beige

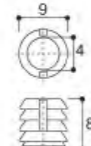

不膨胀(Nonexpansion):  $\varnothing 9 \times 8 \text{mm}$

品名：连接螺母(自攻/机丝)  
Name : Connecting nut(tapping screw)

**LJ039**

主要材质：尼龙  
表面处理：白色  
Material : Nylon  
Finish : White

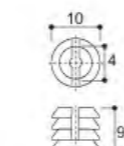

膨胀(Swell):  $\varnothing 9 \times 10 \text{mm}$

品名：连接螺母(机丝)  
Name : Connecting nut

**LJ040**

主要材质：尼龙  
表面处理：白色  
Material : Nylon  
Finish : White

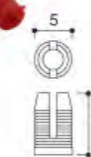

品名：连体排塞  
Name : One-piece row plug

**LJ047**

主要材质：ABS  
表面处理：白色、红色  
Material : ABS  
Finish : White, red

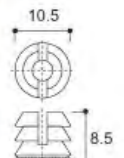

品名：8.5连体膨胀预埋件  
Name : 8.5 one-piece expansion  
embedded part

**LJ048**

主要材质：尼龙  
表面处理：白色、米黄色  
Material : Nylon  
Finish : White, Beige



品名：夹板螺母  
Name: Plywood Nut

**LJ049**

主要材质：铁  
表面处理：镀锌、镀镍  
Material: Iron  
Finish: Zinc, Nickel



品名：夹板螺母  
Name: Plywood Nut

**LJ050**

主要材质：铁  
表面处理：镀锌、镀镍  
Material: Iron  
Finish: Zinc, Nickel



品名：二合一连接件  
Name: 2-In-1 Connecting Piece

**LJ051**

主要材质：塑料、铁  
表面处理：透明、乳白  
Material: Plastic, Iron  
Finish: Transparent, milky white



品名：金属连接件  
Name: Metal connecting piece

**LJ052**

主要材质：铁  
表面处理：镀锌、镀镍  
Material: Iron  
Finish: Zinc, Nickel



品名：合金双脚件  
Name: Alloy double-leg piece

**LJ053**

主要材质：ABS+国标锌合金  
表面处理：白色、米黄色、黑色、灰色、棕色  
Material: ABS+GB Zinc alloy  
Finish: White, Beige, Black, Grey, Brown



品名：塑料双脚件  
Name: Plastic Two-Foot Unit

**LJ054**

主要材质：铁、塑料  
表面处理：白色、棕色  
Material: Iron, Plastic  
Finish: White, Brown



品名：单脚件  
Name: One-Foot Unit

**LJ055**

主要材质：铁、塑料  
表面处理：白色、棕色  
Material: Iron, Plastic  
Finish: White, Brown



品名：塑料偏心件  
Name: Plastic eccentric part

**LJ056**

主要材质：塑料  
表面处理：白、棕  
Material: Plastic  
Finish: White, Brown



品名：三合一层板件  
Name: 3-in-1 laminate piece

**LJ057**

主要材质：ABS+国标锌合金  
表面处理：白色、米黄色、黑色、灰色、棕色  
Material: ABS+GB Zinc alloy  
Finish: White, Beige, Black, Grey, Brown



品名：连接件  
Name: Connector

**LJ058**

主要材质：国标锌合金  
表面处理：镀镍  
Material: GB Zinc alloy  
Finish: Nickel



品名：组合连接件  
Name: Combination connecting piece

**LJ059**

主要材质：国标锌合金  
表面处理：光格、珍珠格、拉丝镍  
Material: GB Zinc alloy  
Finish: Chrome, Pearl chrome, Nickel satin



品名：组合连接件  
Name: Combination connecting piece

**LJ060**

主要材质：铁+国标锌合金  
表面处理：镀锌  
Material: Iron+GB Zinc alloy  
Finish: Zinc



品名：重型四合一  
Name: High duty 4-in-1

**LJ061**

主要材质：铁  
表面处理：镀锌  
Material: Iron  
Finish: Galvanize



品名：重型四合一  
Name: High duty 4-in-1

**LJ062**

主要材质：铁  
表面处理：镀锌  
Material: Iron  
Finish: Galvanize



品名：连接件  
Name: Connector

**LJ063**

主要材质：锌合金、铁  
表面处理：镀镍  
Materials: Zinc alloy, Iron  
Finish: Nickel



品名：连接件  
Name: Connector

**LJ064**

主要材质：锌合金、铁  
表面处理：镀镍  
Materials: Zinc alloy, Iron  
Finish: Nickel



品名：连接件  
Name: Connector

**LJ065**

主要材质：锌合金、铁  
表面处理：镀镍  
Materials: Zinc alloy, Iron  
Finish: Nickel



锌合金梯形螺母  
Zinc Alloy Trapezoidal Nut



LJ066 KIN

锌合金梯形螺母规格

品名	M	L	品名	M	L	品名	M	L
4x10有介	4	10	4x10无介	4	10	4x10有介刺母	4	10
5x10有介	5	10	5x10无介	5	10	5x10有介刺母	5	10
6x10有介	6	10	6x10无介	6	10	6x10有介刺母	6	10
6x13有介	6	13	6x13无介	6	13	4x10无介刺母	4	10
6x15有介	6	15	6x15无介	6	15	5x10无介刺母	5	10
6x18有介	6	18	6x18无介	6	18	6x10无介刺母	6	10
6x20有介	6	20	6x20无介	6	20			
6x25有介	6	25	6x25无介	6	25			
8x13有介	8	13	8x13无介	8	13			
8x15有介	8	15	8x15无介	8	15			
8x18有介	8	18	8x18无介	8	18			
8x20有介	8	20	8x20无介	8	20			
8x25有介	8	25	8x25无介	8	25	8x25平底	8	25
8x30有介	8	30	8x30无介	8	30	8x30平底	8	30
10x15有介	10	15	10x15无介	10	15			
10x20有介	10	20	10x20无介	10	20			
10x25有介	10	25	10x25无介	10	25			
10x30有介	10	30	10x30无介	10	30			

铁内外牙螺母  
Iron Insert Nut



LJ067 KIN

铁内外牙螺母规格

品名	M	L	品名	M	L	品名	M	L
6x8直通(内外牙)	6	8	6x10沉头(内外牙)	6	10	8x20盲孔(内外牙)	8	20
6x10直通(内外牙)	6	10	6x12沉头(内外牙)	6	12	8x25盲孔(内外牙)	8	25
6x12直通(内外牙)	6	12	6x13沉头(内外牙)	6	13	8x30盲孔(内外牙)	8	30
6x13直通(内外牙)	6	13	6x14沉头(内外牙)	6	14	8x15直通(内六角)	8	15
6x15直通(内外牙)	6	15	6x15沉头(内外牙)	6	15	8x18直通(内六角)	8	18
6x17直通(内外牙)	6	17	6x17沉头(内外牙)	6	17	8x20直通(内六角)	8	20
6x20直通(内外牙)	6	20	6x20沉头(内外牙)	6	20	8x25直通(内六角)	8	25
6x25直通(内外牙)	6	25	6x25沉头(内外牙)	6	25	8x30直通(内六角)	8	30
8x12直通(内外牙)	8	12	6x20沉头(内外牙)大介	6	20			
8x14直通(内外牙)	8	14	6x24沉头(内外牙)大介	6	24			
8x15直通(内外牙)	8	15	8x13沉头(内外牙)	8	13			
8x17直通(内外牙)	8	17	8x14沉头(内外牙)	8	14			
8x20直通(内外牙)	8	20	8x15沉头(内外牙)	8	15			
8x22直通(内外牙)	8	22	8x17沉头(内外牙)	8	17			
8x25直通(内外牙)	8	25	8x20沉头(内外牙)	8	20			
8x30直通(内外牙)	8	30	8x22沉头(内外牙)	8	22			
10x15直通(内外牙)	10	15	8x25沉头(内外牙)	8	25			
10x20直通(内外牙)	10	20	8x30沉头(内外牙)	8	30			
10x25直通(内外牙)	10	25	10x20沉头(内外牙)	10	20			
			10x25沉头(内外牙)	10	25			



品名：锤子螺母  
Name: Hammer nut  
**LJ068**

主要材质：铁  
表面处理：镀锌  
Material: Iron  
Finish: Zinc



品名：锤子螺母  
Name: Hammer nut  
**LJ069**

主要材质：铁  
表面处理：镀锌  
Material: Iron  
Finish: Zinc



品名：锤子螺母  
Name: Hammer nut  
**LJ070**

主要材质：铁  
表面处理：镀锌  
Material: Iron  
Finish: Zinc



品名：锤子螺母  
Name: Hammer nut  
**LJ071**

主要材质：国际锌合金  
表面处理：镀锌  
Material: GB Zinc alloy  
Finish: Zinc



品名：锤子螺母  
Name: Hammer nut  
**LJ072**

主要材质：国际锌合金  
表面处理：镀锌  
Material: GB Zinc alloy  
Finish: Zinc



品名：锤子螺母  
Name: Hammer nut  
**LJ073**

主要材质：国际锌合金  
表面处理：镀锌  
Material: GB Zinc alloy  
Finish: Zinc



品名：锤子螺母  
Name: Hammer nut  
**LJ074**

主要材质：国际锌合金  
表面处理：镀锌  
Material: GB Zinc alloy  
Finish: Zinc



品名：锤子螺母  
Name: Hammer nut  
**LJ075**

主要材质：国际锌合金  
表面处理：镀锌  
Material: GB Zinc alloy  
Finish: Zinc



品名：锤子螺母  
Name: Hammer nut  
**LJ076**

主要材质：塑料  
表面处理：白色、灰色  
Material: Plastic  
Finish: White, Grey



品名：锤子螺母  
Name: Hammer nut  
**LJ077**

主要材质：塑料  
表面处理：白色、灰色  
Material: Plastic  
Finish: White, Grey



品名：锤子螺母  
Name: Hammer nut  
**LJ078**

主要材质：塑料  
表面处理：白色、灰色  
Material: Plastic  
Finish: White, Grey



品名：蝶型螺母  
Name: Butterfly nut  
**LJ079**

主要材质：国际锌合金  
表面处理：镀锌  
Material: GB Zinc alloy  
Finish: Zinc



品名：大月形  
Name: Big selene  
**LJ080**

主要材质：ABS  
表面处理：白色、米黄色、黑色  
Material: GB Zinc alloy  
Finish: White, Cream, Black



品名：小月形  
Name: Small selene  
**LJ081**

主要材质：ABS  
表面处理：白色、米黄色、黑色  
Material: GB Zinc alloy  
Finish: White, Cream, Black

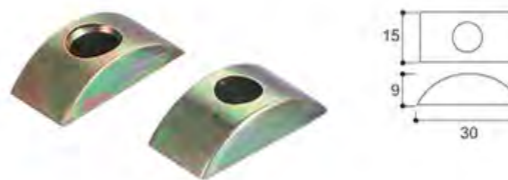

品名：月形垫  
Name: Crescent mat  
**LJ082**

主要材质：合金  
表面处理：镀锌  
Material: Alloy  
Finish: Zinc



品名：月形垫  
Name: Crescent mat  
**LJ083**

主要材质：合金  
表面处理：镀锌  
Material: Alloy  
Finish: Zinc



品名：圆形连接件  
Name: Connecting parts  
**LJ084**

主要材质：国际锌合金  
表面处理：镀锌  
Material: GB Zinc alloy  
Finish: Zinc



品名：半月形  
Name: Semilune  
**LJ085**

主要材质：国际锌合金  
表面处理：镀锌  
Material: GB Zinc alloy  
Finish: Zinc



品名：预埋件  
Name: Embedded parts  
**LJ086**

主要材质：国际锌合金  
表面处理：镀锌  
Material: GB Zinc alloy  
Finish: Zinc



品名：预埋件  
Name: Embedded parts  
**LJ087**

主要材质：国际锌合金  
表面处理：镀锌  
Material: GB Zinc alloy  
Finish: Zinc



品名：夹板螺母  
Name: Splint nut  
**LJ088**

主要材质：铁  
表面处理：镀锌  
Material: Iron  
Finish: Zinc



品名：夹板螺母  
Name: Splint nut  
**LJ089**

主要材质：铁  
表面处理：镀锌  
Material: Iron  
Finish: Zinc



品名：4爪螺母  
Name: 4 Claw nut  
**LJ090**

主要材质：铁  
表面处理：镀锌  
Material: Iron  
Finish: Zinc



品名：4爪螺母  
Name: 4 Claw nut  
**LJ091**

主要材质：铁  
表面处理：镀锌  
Material: Iron  
Finish: Zinc



品名：普通自攻丝  
Name: Common tapping screw  
**LJ092**

主要材质：铁  
表面处理：镀锌、镀镍  
Material: Iron  
Finish: Zinc, Nickel

Ø	L
M3	10-70mm
M3.5	10-70mm
M4	10-70mm

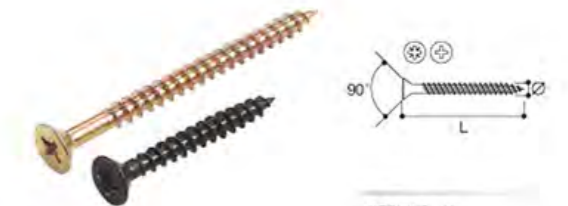

品名：加硬纤维自攻螺丝  
Name: Hardened fiber tapping screw  
**LJ093**

主要材质：铁  
表面处理：黑、白、彩、镍  
Material: Iron  
Finish: Black, White, Color, Nickel

Ø	L
M3.5	12-40mm
M4.0	12-55mm



品名：倒边十字自攻螺丝  
Name: Beveled tapping screw  
**LJ094**

主要材质：铁  
表面处理：白、彩、镍  
Material: Iron  
Finish: White, Color, Nickel

Ø	L
M5	25-80mm



品名：单牙干壁钉(快速牙)  
Name: Single-thread wall screw (fast thread)  
**LJ095**

主要材质：铁  
表面处理：黑、白、彩、镍  
Material: Iron  
Finish: Black, White, Color, Nickel

Ø	L
M4	12-40mm



品名：倒边十字机丝  
Name: Chamfered Phillips head screw  
**LJ096**

主要材质：铁  
表面处理：黑、白、彩、镍  
Material: Iron  
Finish: Black, White, Color, Nickel

Ø	L
M6	12-120mm
M8	12-120mm



品名：拉手螺丝  
Name: Handle screw  
**LJ097**

主要材质：铁  
表面处理：黑、白、彩、镍  
Material: Iron  
Finish: Black, White, Color, Nickel

Ø	L
M4	12-100mm



品名：木牙螺丝  
Name: Wood screw  
**LJ098**

主要材质：铁  
表面处理：黑、白、彩、镍  
Material: Iron  
Finish: Black, White, Color, Nickel

Ø	L
M5	38-70mm
M7	38-70mm



品名：双头牙(全牙)螺丝  
Name: Double-thread (full-thread) screw  
**LJ099**

主要材质：铁  
表面处理：镀锌、白锌  
Material: Iron  
Finish: Zinc Color/White zinc

Ø	L
M6	30-60mm
M8	40-100mm
M10	60-120mm



品名：打扁双头牙  
Name: Flat full-thread

**LJ100**

Ø	L
M6	30-60mm
M8	40-100mm
M10	60-120mm

主要材质：铁  
表面处理：镀锌、白锌  
Material: Iron  
Finish: Zinc Color/  
White zinc



品名：双尖螺丝  
Name: Double pointed screw

**LJ101**

Ø	L
M6	30-60mm
M8	40-100mm
M10	60-120mm

主要材质：铁  
表面处理：镀锌、白锌  
Material: Iron  
Finish: Zinc Color/  
White zinc

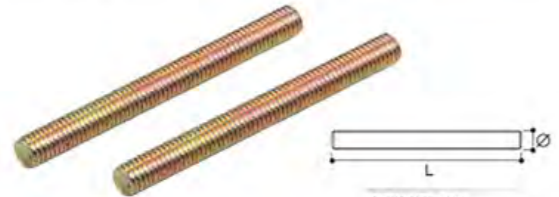

品名：全牙螺丝  
Name: Full-thread screw

**LJ102**

Ø	L
M6	20-120mm
M8	20-120mm
M12	20-120mm

主要材质：铁  
表面处理：镀锌、白锌  
Material: Iron  
Finish: Zinc Color/  
White zinc



品名：两头牙螺杆  
Name: Dual-end screw

**LJ103**

Ø	L
M6	20-120mm
M8	20-120mm
M12	20-120mm

主要材质：铁  
表面处理：镀锌、白锌  
Material: Iron  
Finish: Zinc Color/  
White zinc



品名：拉爆螺丝  
Name: Anchor bolt

**LJ104**

主要材质：铁+塑料  
表面处理：镀锌  
Material: Iron+Plastic  
Finish: Zinc



品名：拉爆螺丝  
Name: Anchor bolt

**LJ105**

主要材质：铁+塑料  
表面处理：镀锌  
Material: Iron+Plastic  
Finish: Zinc



品名：外六角扳手  
Name: Outside hexagon spanner

**LJ106**

主要材质：铁+塑料  
表面处理：镀锌  
Material: Iron+Plastic  
Finish: Zinc

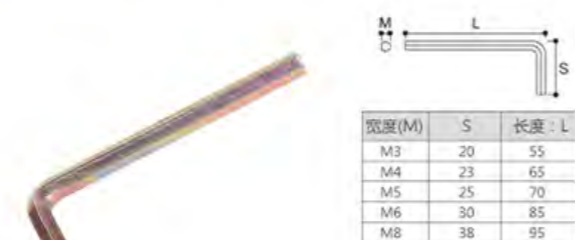

品名：L型六角匙  
Name: L-shaped Allen key

**LJ107**

主要材质：铁  
表面处理：黑、白、彩、镍  
Material: Iron  
Finish: Black/White/Color/  
/Nickel

宽度(M)	S	长度: L
M3	20	55
M4	23	65
M5	25	70
M6	30	85
M8	38	95
M10	48	120



品名：三合一盖  
Name: 3 in 1 cap

**LJ108**

主要材质：塑料  
表面处理：黑色、白色、棕色、米黄色  
Material: Plastic  
Finish: Black, White, Brown, Cream



品名：三合一盖  
Name: 3 in 1 cap

**LJ110**

主要材质：塑料  
表面处理：黑色、白色、棕色、米黄色  
Material: Plastic  
Finish: Black, White, Brown, Cream



品名：螺丝装饰盖  
Name: Screw cover cap

**LJ112**

主要材质：ABS  
表面处理：黑色、白色、棕色、米黄色  
Material: ABS  
Finish: Black, White, Brown, Cream



品名：装饰盖  
Name: Cover cap

**LJ114**

主要材质：塑料  
表面处理：黑色、白色、棕色、米黄色  
Material: Plastic  
Finish: Black, White, Brown, Cream



品名：装饰盖  
Name: Cover cap

**LJ116**

主要材质：塑料  
表面处理：黑色、白色、棕色、米黄色  
Material: Plastic  
Finish: Black, White, Brown, Cream



品名：三合一盖  
Name: 3 in 1 cap

**LJ109**

主要材质：塑料  
表面处理：黑色、白色、棕色、米黄色  
Material: Plastic  
Finish: Black, White, Brown, Cream



品名：三合一盖  
Name: 3 in 1 cap

**LJ111**

主要材质：ABS  
表面处理：黑色、白色、棕色、米黄色  
Material: ABS  
Finish: Black, White, Brown, Cream



品名：螺丝装饰盖  
Name: Screw cover cap

**LJ113**

主要材质：ABS  
表面处理：黑色、白色、棕色、米黄色  
Material: ABS  
Finish: Black, White, Brown, Cream



品名：5厘米孔塞  
Name: 5cm Hole Plug

**LJ115**

主要材质：ABS  
表面处理：黑色、白色、棕色、米黄色  
Material: ABS  
Finish: Black, White, Brown, Cream



品名：装饰盖  
Name: Cover cap

**LJ117**

主要材质：塑料  
表面处理：黑色、白色、棕色、米黄色  
Material: Plastic  
Finish: Black, White, Brown, Cream

HD-01	HD-02	HD-03	HD-04	HD-05	HD-06	HD-07
HD-08	HD-09	HD-10	JM-001	JM-002	JM-003	JM-004
JM-005	JM-006	JM-007	JM-008	JM-009	JM-010	JM-011
JM-012	JM-013	JM-014	JM-015	JM-016	JM-017	JM-018
JM-019	JM-020	JM-021	JM-022	JM-023	JM-024	JM-025
JM-026	JM-027	JM-028	JM-029	JM-030		

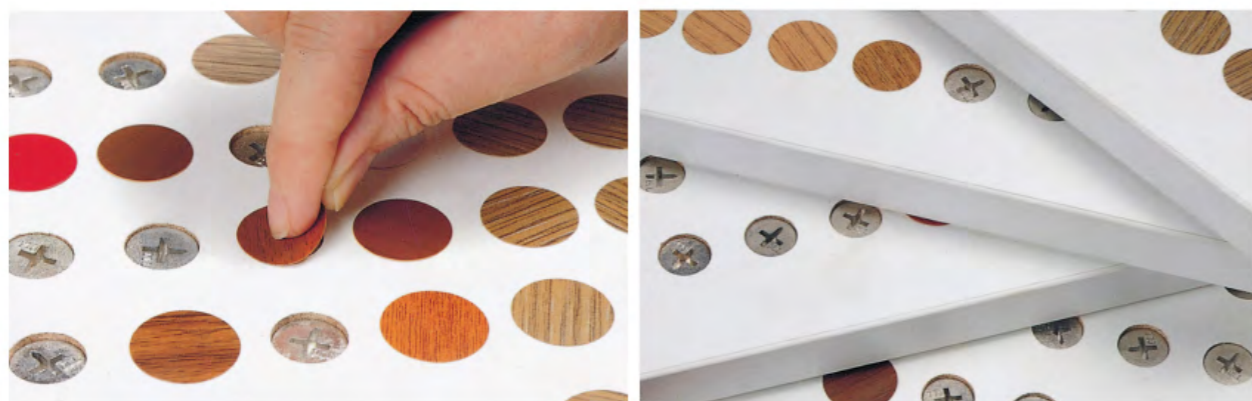





品名：三合一层板件  
Name : 3-in-1 laminate piece

**TG001**

主要材质：ABS+国标锌合金  
表面处理：白色、米黄色、  
黑色、灰色、棕色  
Material : ABS+GB Zinc alloy  
Finish : White, Beige,  
Black, Grey, Brown



品名：三合一层板件  
Name : 3-in-1 laminate piece

**TG002**

主要材质：ABS+国标锌合金  
表面处理：白色、米黄色、  
黑色、灰色、棕色  
Material : ABS+GB Zinc alloy  
Finish : White, Beige,  
Black, Grey, Brown



品名：二合一层板件  
Name : 2-in-1 laminate piece

**TG003**

主要材质：ABS+铁  
表面处理：白色、黑色、  
灰色、棕色  
Material : ABS+Iron  
Finish : White, Black,  
Grey, Brown



品名：三合一层板件  
Name : 3-in-1 laminate piece

**TG004**

主要材质：ABS+铁  
表面处理：白色、黑色、  
灰色、棕色  
Material : ABS+Iron  
Finish : White, Black,  
Grey, Brown



品名：三合一层板件  
Name : 3-in-1 laminate piece

**TG005**

主要材质：ABS+  
国标锌合金  
表面处理：镀镍  
Material : ABS+  
GB Zinc alloy  
Finish : Nickel



品名：三合一层板件  
Name : 3-in-1 laminate piece

**TG006**

主要材质：ABS+  
国标锌合金  
表面处理：镀镍  
Material : ABS+  
GB Zinc alloy  
Finish : Nickel



品名：三合一层板件  
Name : 3-in-1 laminate piece

**TG007**

主要材质：国标锌合金  
表面处理：镀镍  
Material : GB Zinc alloy  
Finish : Nickel



品名：三合一层板件  
Name : 3-in-1 laminate piece

**TG008**

主要材质：国标锌合金  
表面处理：镀镍  
Material : GB Zinc alloy  
Finish : Nickel



品名：三合一层板件  
Name : 3-in-1 laminate piece

**TG009**

主要材质：ABS+国标锌合金  
表面处理：白色、棕色、黑色  
Material : ABS+GB Zinc alloy  
Finish : White, Brown,  
Black



品名：三合一层板件  
Name : 3-in-1 laminate piece

**TG010**

主要材质：国标锌合金  
表面处理：镀镍  
Material : GB Zinc alloy  
Finish : Nickel



品名：层板托  
Name : Shelf support

**TG011**

主要材质：ABS+铁  
表面处理：灰色、白色  
Material : ABS+Iron  
Finish : Gray, white



品名：三合一层板件  
Name : 3-in-1 laminate piece

**TG012**

主要材质：ABS+  
国标锌合金  
表面处理：镀镍  
Material : ABS+  
GB Zinc alloy  
Finish : Nickel



品名：隐形层板托  
Name : Invisible shelf support

**TG013**

主要材质：铁  
表面处理：镀锌  
Material : Iron  
Finish : Zinc



品名：隐形层板托  
Name : Invisible shelf support

**TG014**

主要材质：铁  
表面处理：镀锌  
Material : Iron  
Finish : Zinc



品名：层板托  
Name : Shelf support

**TG015**

主要材质：ABS+铁  
表面处理：白色  
Material : ABS+Iron  
Finish : White



品名：层板托  
Name : Shelf support

**TG016**

主要材质：ABS+铁  
表面处理：白色  
Material : ABS+Iron  
Finish : White



品名：层板托  
Name: Shelf support  
**TG017**

主要材质：ABS+铁  
表面处理：透明、白色、棕色  
Material: ABS+Iron  
Finish: Transparent, White, Brown



品名：层板托  
Name: Shelf support  
**TG018**

主要材质：ABS+铁  
表面处理：透明、白色、棕色  
Material: ABS+Iron  
Finish: Transparent, White, Brown



品名：背板扣  
Name: Backboard Buckle  
**TG025**

主要材质：ABS  
表面处理：白色  
Material: ABS  
Finish: White



品名：背板扣  
Name: Backboard Buckle  
**TG026**

主要材质：ABS  
表面处理：白色、透明  
Material: ABS  
Finish: White, Transparent



品名：层板托  
Name: Shelf support  
**TG019**

主要材质：ABS  
表面处理：白色、透明  
Material: ABS  
Finish: White, Transparent



品名：层板托  
Name: Shelf support  
**TG020**

主要材质：ABS+铁  
表面处理：透明  
Material: ABS+Iron  
Finish: Transparent



品名：层板托  
Name: Shelf support  
**TG027**

主要材质：ABS  
表面处理：透明、白色、棕色  
Material: ABS  
Finish: Transparent, White, Brown



品名：层板托  
Name: Shelf support  
**TG028**

主要材质：ABS  
表面处理：黑色、白色、棕色、米黄色  
Material: ABS  
Finish: Black / White / Brown / Cream



品名：层板托  
Name: Shelf support  
**TG021**

主要材质：ABS  
表面处理：白色、透明  
Material: ABS  
Finish: White, Transparent



品名：层板托  
Name: Shelf support  
**TG022**

主要材质：ABS  
表面处理：白色、透明  
Material: ABS  
Finish: White, Transparent



品名：中轴  
Name: Mean axis  
**TG029**

材质：ABS  
表面处理：白色、米黄色  
Material: ABS  
Finish: White, Cream



品名：层板托  
Name: Shelf support  
**TG030**

主要材质：ABS  
表面处理：白色、透明  
Material: ABS  
Finish: White, Transparent



品名：层板托  
Name: Shelf support  
**TG023**

主要材质：ABS  
表面处理：白色、透明  
Material: ABS  
Finish: White, Transparent



品名：层板托  
Name: Shelf support  
**TG024**

主要材质：ABS  
表面处理：白色、透明  
Material: ABS  
Finish: White, Transparent



品名：层板托  
Name: Shelf support  
**TG031**

主要材质：ABS  
表面处理：白色、棕色、透明  
Material: ABS  
Finish: White, Brown, Transparent



品名：层板托  
Name: Shelf support  
**TG032**

主要材质：ABS  
表面处理：透明、白色、棕色  
Material: ABS  
Finish: Transparent, White, Brown

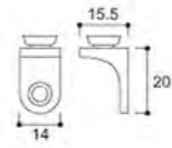

品名：层板托  
Name: Shelf support  
**TG033**

主要材质：国标锌合金  
表面处理：光络、拉丝镍  
Material: GB Zinc alloy  
Finish: Chrome, Nickel satin

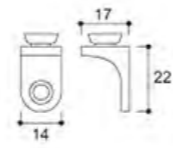

品名：层板托  
Name: Shelf support  
**TG034**

主要材质：国标锌合金  
表面处理：光络、拉丝镍  
Material: GB Zinc alloy  
Finish: Chrome, Nickel satin

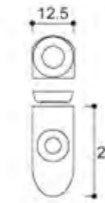

品名：层板托  
Name: Shelf support  
**TG041**

主要材质：国标锌合金  
表面处理：光络、拉丝镍  
Material: GB Zinc alloy  
Finish: Chrome, Nickel satin

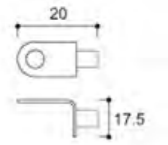

品名：层板托  
Name: Shelf support  
**TG042**

主要材质：铁  
表面处理：黑色  
Material: Iron  
Finish: Black

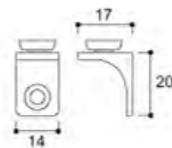

品名：层板托  
Name: Shelf support  
**TG035**

主要材质：国标锌合金  
表面处理：光络、拉丝镍  
Material: GB Zinc alloy  
Finish: Chrome, Nickel satin

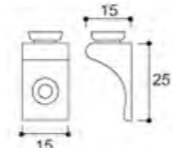

品名：层板托  
Name: Shelf support  
**TG036**

主要材质：国标锌合金  
表面处理：光络、拉丝镍  
Material: GB Zinc alloy  
Finish: Chrome, Nickel satin

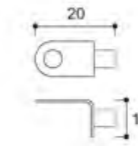

品名：层板托  
Name: Shelf support  
**TG043**

主要材质：铁  
表面处理：镍  
Material: Iron  
Finish: Nickel

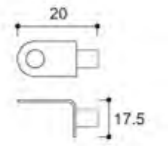

品名：层板托  
Name: Shelf support  
**TG044**

主要材质：铁  
表面处理：镍  
Material: Iron  
Finish: Nickel

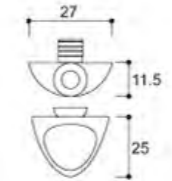

品名：层板托  
Name: Shelf support  
**TG037**

主要材质：国标锌合金  
表面处理：光络、拉丝镍  
Material: GB Zinc alloy  
Finish: Chrome, Nickel satin

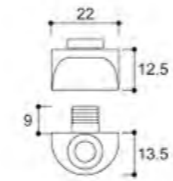

品名：层板托  
Name: Shelf support  
**TG038**

主要材质：国标锌合金  
表面处理：光络、拉丝镍  
Material: GB Zinc alloy  
Finish: Chrome, Nickel satin

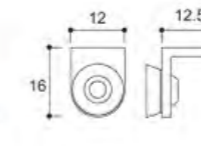

品名：层板托  
Name: Shelf support  
**TG045**

主要材质：国标锌合金  
表面处理：镀镍  
Material: GB Zinc alloy  
Finish: Nickel

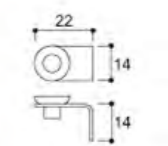

品名：大吸盘板托  
Name: Big sucker shelf support  
**TG046**

主要材质：铁  
表面处理：镀镍  
Material: Iron  
Finish: Nickel

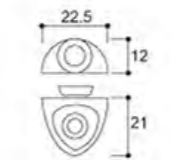

品名：层板托  
Name: Shelf support  
**TG039**

主要材质：国标锌合金  
表面处理：光络、拉丝镍  
Material: GB Zinc alloy  
Finish: Chrome, Nickel satin

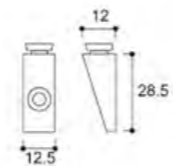

品名：层板托  
Name: Shelf support  
**TG040**

主要材质：国标锌合金  
表面处理：光络、拉丝镍  
Material: GB Zinc alloy  
Finish: Chrome, Nickel satin

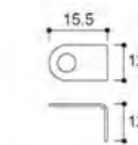

品名：中吸盘板托  
Name: Medium sucker shelf support  
**TG047**

主要材质：铁  
表面处理：镀镍  
Material: Iron  
Finish: Nickel

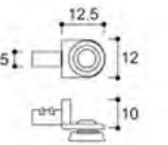

品名：膨胀板托  
Name: Expansion shelf support  
**TG048**

主要材质：国标锌合金  
表面处理：镀镍  
Material: GB Zinc alloy  
Finish: Nickel



品名：小吸盘板托  
Name: Small sucker shelf support  
**TG049**

主要材质：国标锌合金  
表面处理：镀镍  
Material: GB Zinc alloy  
Finish: Nickel



品名：大吸盘板托  
Name: Big sucker shelf support  
**TG050**

主要材质：国标锌合金  
表面处理：镀镍  
Material: GB Zinc alloy  
Finish: Nickel



品名：7字板托  
Name: 7-shaped shelf support  
**TG057**

主要材质：国标锌合金  
表面处理：镀镍  
Material: GB Zinc alloy  
Finish: Nickel



品名：缓冲板托  
Name: Buffering shelf support  
**TG058**

主要材质：国标锌合金  
表面处理：镀镍  
Material: GB Zinc alloy  
Finish: Nickel



品名：无牙大板托  
Name: Toothless big shelf support  
**TG051**

主要材质：国标锌合金  
表面处理：镀镍  
Material: GB Zinc alloy  
Finish: Nickel



品名：带脚板托  
Name: Shelf support with leg  
**TG052**

主要材质：国标锌合金  
表面处理：镀镍  
Material: GB Zinc alloy  
Finish: Nickel



品名：层板托  
Name: Shelf support  
**TG059**

主要材质：国标锌合金  
表面处理：镀镍  
Material: GB Zinc alloy  
Finish: Nickel



品名：层板托  
Name: Shelf support  
**TG060**

主要材质：国标锌合金  
表面处理：镀镍  
Material: GB Zinc alloy  
Finish: Nickel



品名：层板托  
Name: Shelf support  
**TG053**

主要材质：国标锌合金  
表面处理：光路、拉丝镍  
Material: GB Zinc alloy  
Finish: Chrome, Nickel satin



品名：层板托  
Name: Shelf support  
**TG054**

主要材质：国标锌合金  
表面处理：光路、拉丝镍  
Material: GB Zinc alloy  
Finish: Chrome, Nickel satin



品名：层板托  
Name: Shelf support  
**TG061**

主要材质：铁  
表面处理：镀镍  
Material: Iron  
Finish: Nickel



品名：层板托  
Name: Shelf support  
**TG062**

主要材质：铁  
表面处理：镀镍  
Material: Iron  
Finish: Nickel



品名：双脚板托  
Name: Double-leg shelf support  
**TG055**

主要材质：国标锌合金  
表面处理：镀镍  
Material: GB Zinc alloy  
Finish: Nickel



品名：定位板托  
Name: Fixed position shelf support  
**TG056**

主要材质：国标锌合金  
表面处理：镀镍  
Material: GB Zinc alloy  
Finish: Nickel



品名：层板托  
Name: Shelf support  
**TG063**

主要材质：铁  
表面处理：镍  
Material: Iron  
Finish: Nickel



品名：层板托  
Name: Shelf support  
**TG064**

主要材质：铁  
表面处理：镍  
Material: Iron  
Finish: Nickel



品名：层板托  
Name: Shelf support  
**TG065**

主要材质：铁  
表面处理：镍  
Material: Iron  
Finish: Nickel



品名：8mm层板托  
Name: 8mm Shelf support  
**TG066**

主要材质：铁  
表面处理：镍  
Material: Iron  
Finish: Nickel



品名：8x21胶圈板托  
Name: 8x21 Rubber gasket shelf support  
**TG067**

主要材质：铁  
表面处理：镍  
Material: Iron  
Finish: Nickel



品名：9x17胶圈板托  
Name: 9x17 Rubber gasket shelf support  
**TG068**

规格 (Size):  
17, 20, 23, 25  
主要材质：铜  
表面处理：镍  
Material: Brass  
Finish: Nickel



品名：6mm中轴  
Name: 6-mm middle axle  
**TG069**

主要材质：铁  
表面处理：镍  
Material: Iron  
Finish: Nickel



品名：5mm中轴  
Name: 5-mm middle axle  
**TG070**

主要材质：铁  
表面处理：镍  
Material: Iron  
Finish: Nickel



品名：二级层板托  
Name: Second level shelf supports  
**TG071**

主要材质：铁  
表面处理：镍  
Material: Iron  
Finish: Nickel



品名：5cm中轴(带套)  
Name: 5 cm axle (with sleeve)  
**TG072**

主要材质：铁+塑料  
表面处理：镍  
Material: Iron+Plastic  
Finish: Nickel



品名：玻璃夹  
Name: Glass clip  
**TG073**

主要材质：国标锌合金  
表面处理：光铬、珍珠铬、拉丝镍  
Material: GB Zinc alloy  
Finish: Chrome, Pearl chrome, Nickel satin

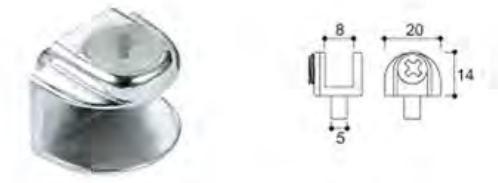

品名：玻璃夹  
Name: Glass clip  
**TG074**

主要材质：国标锌合金  
表面处理：光铬、珍珠铬、拉丝镍  
Material: GB Zinc alloy  
Finish: Chrome, Pearl chrome, Nickel satin



品名：玻璃夹  
Name: Glass clip  
**TG075**

主要材质：国标锌合金  
表面处理：光铬、珍珠铬、拉丝镍  
Material: GB Zinc alloy  
Finish: Chrome, Pearl chrome, Nickel satin



品名：玻璃夹  
Name: Glass clip  
**TG076**

主要材质：国标锌合金  
表面处理：光铬、珍珠铬、拉丝镍  
Material: GB Zinc alloy  
Finish: Chrome, Pearl chrome, Nickel satin



品名：玻璃夹  
Name: Glass clip  
**TG077**

主要材质：国标锌合金  
表面处理：光铬、珍珠铬、拉丝镍  
Material: GB Zinc alloy  
Finish: Chrome, Pearl chrome, Nickel satin



品名：玻璃夹  
Name: Glass clip  
**TG078**

主要材质：国标锌合金  
表面处理：镍  
Material: GB Zinc alloy  
Finish: Nickel



品名：玻璃夹  
Name: Glass clip  
**TG079**

主要材质：国标锌合金  
表面处理：光铬、珍珠铬、拉丝镍  
Material: GB Zinc alloy  
Finish: Chrome, Pearl chrome, Nickel satin



品名：膨胀玻璃夹  
Name: Expansion glass clip  
**TG080**

主要材质：国标锌合金  
表面处理：光铬、珍珠铬  
Material: GB Zinc alloy  
Finish: Chrome, Pearl nickel

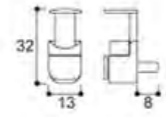

品名：玻璃夹  
Name: Glass clip

**TG081** MING JIN

主要材质：国标锌合金  
表面处理：光格、珍珠格、拉丝镍  
Material: GB Zinc alloy  
Finish: Chrome, Pearl chrome, Nickel satin

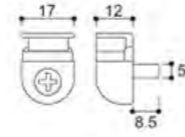

品名：玻璃夹  
Name: Glass clip

**TG082**

主要材质：国标锌合金  
表面处理：光格、珍珠格、拉丝镍  
Material: GB Zinc alloy  
Finish: Chrome, Pearl chrome, Nickel satin

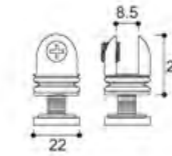

品名：半边玻璃夹  
Name: semi-side glass clip

**TG089**

主要材质：国标锌合金  
表面处理：光格、珍珠格、拉丝镍  
Material: GB Zinc alloy  
Finish: Chrome, Pearl chrome, Nickel satin

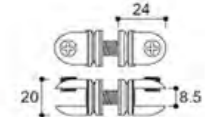

品名：双边玻璃夹  
Name: Dual-size glass clip

**TG090**

主要材质：国标锌合金  
表面处理：光格、珍珠格、拉丝镍  
Material: GB Zinc alloy  
Finish: Chrome, Pearl chrome, Nickel satin

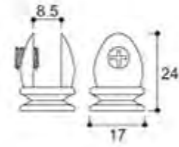

品名：单边玻璃夹  
Name: Single-side glass clip

**TG083**

主要材质：国标锌合金  
表面处理：光格、珍珠格、拉丝镍  
Material: GB Zinc alloy  
Finish: Chrome, Pearl chrome, Nickel satin

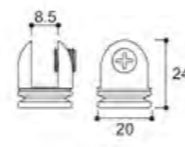

品名：单边玻璃夹  
Name: Single-side glass clip

**TG084**

主要材质：国标锌合金  
表面处理：光格、珍珠格、拉丝镍  
Material: GB Zinc alloy  
Finish: Chrome, Pearl chrome, Nickel satin

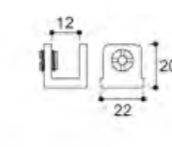

品名：圆柱玻璃夹  
Name: Cylinder glass clip

**TG091**

主要材质：国标锌合金  
表面处理：光格、珍珠格、拉丝镍  
Material: GB Zinc alloy  
Finish: Chrome, Pearl chrome, Nickel satin

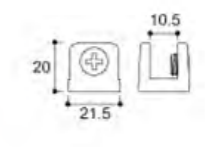

品名：圆柱玻璃夹  
Name: Cylinder glass clip

**TG092**

主要材质：国标锌合金  
表面处理：光格、珍珠格、拉丝镍  
Material: GB Zinc alloy  
Finish: Chrome, Pearl chrome, Nickel satin

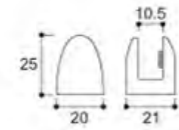

品名：单头玻璃夹  
Name: Single-head glass clip

**TG085**

主要材质：国标锌合金  
表面处理：光格、珍珠格、拉丝镍  
Material: GB Zinc alloy  
Finish: Chrome, Pearl chrome, Nickel satin

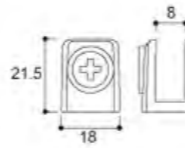

品名：玻璃夹  
Name: Glass clip

**TG086**

主要材质：国标锌合金  
表面处理：光格、珍珠格、拉丝镍  
Material: GB Zinc alloy  
Finish: Chrome, Pearl chrome, Nickel satin

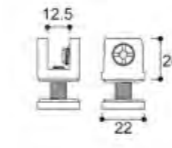

品名：单边玻璃夹  
Name: Single-side glass clip

**TG093**

主要材质：国标锌合金  
表面处理：光格、珍珠格、拉丝镍  
Material: GB Zinc alloy  
Finish: Chrome, Pearl chrome, Nickel satin

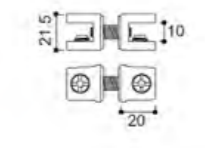

品名：双边玻璃夹  
Name: Dual-size glass clip

**TG094**

主要材质：国标锌合金  
表面处理：光格、珍珠格、拉丝镍  
Material: GB Zinc alloy  
Finish: Chrome, Pearl chrome, Nickel satin

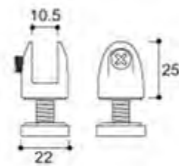

品名：单边玻璃夹  
Name: Single-side glass clip

**TG087**

主要材质：国标锌合金  
表面处理：光格、珍珠格、拉丝镍  
Material: GB Zinc alloy  
Finish: Chrome, Pearl chrome, Nickel satin

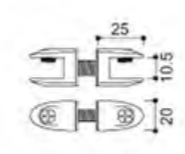

品名：双边玻璃夹  
Name: Dual-size glass clip

**TG088**

主要材质：国标锌合金  
表面处理：光格、珍珠格、拉丝镍  
Material: GB Zinc alloy  
Finish: Chrome, Pearl chrome, Nickel satin

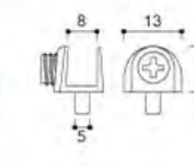

品名：玻璃夹  
Name: Glass clip

**TG095**

主要材质：国标锌合金  
表面处理：光格、珍珠格、拉丝镍  
Material: GB Zinc alloy  
Finish: Chrome, Pearl chrome, Nickel satin

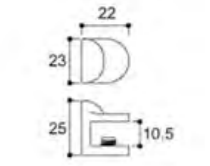

品名：玻璃夹  
Name: Glass clip

**TG096**

主要材质：国标锌合金  
表面处理：光格、珍珠格、拉丝镍  
Material: GB Zinc alloy  
Finish: Chrome, Pearl chrome, Nickel satin

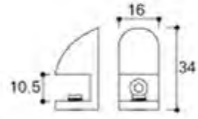

品名：玻璃夹  
Name: Glass clip

**TG097**

主要材质：国标锌合金  
表面处理：光铬、珍珠铬、拉丝镍  
Material: GB Zinc alloy  
Finish: Chrome, Pearl chrome, Nickel satin

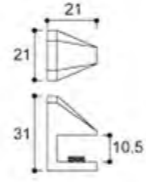

品名：玻璃夹  
Name: Glass clip

**TG098**

主要材质：国标锌合金  
表面处理：光铬、珍珠铬、拉丝镍  
Material: GB Zinc alloy  
Finish: Chrome, Pearl chrome, Nickel satin

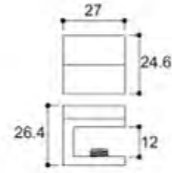

品名：玻璃夹  
Name: Glass clip

**TG099**

主要材质：国标锌合金  
表面处理：光铬、珍珠铬、拉丝镍  
Material: GB Zinc alloy  
Finish: Chrome, Pearl chrome, Nickel satin

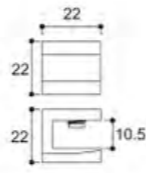

品名：玻璃夹  
Name: Glass clip

**TG100**

主要材质：国标锌合金  
表面处理：光铬、珍珠铬、拉丝镍  
Material: GB Zinc alloy  
Finish: Chrome, Pearl chrome, Nickel satin

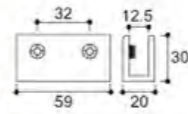

品名：长方形玻璃夹  
Name: Rectangle Glass clip

**TG101**

主要材质：国标锌合金  
表面处理：光铬、珍珠铬、拉丝镍  
Material: GB Zinc alloy  
Finish: Chrome, Pearl chrome, Nickel satin

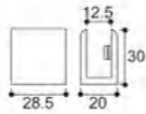

品名：方形玻璃夹  
Name: Rectangle Glass clip

**TG102**

主要材质：国标锌合金  
表面处理：光铬、珍珠铬、拉丝镍  
Material: GB Zinc alloy  
Finish: Chrome, Pearl chrome, Nickel satin

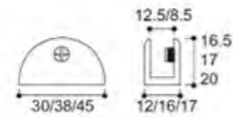

品名：半圆玻璃夹  
Name: Semicircular glass clip

**TG103**

主要材质：国标锌合金  
表面处理：光铬、珍珠铬、拉丝镍  
Material: GB Zinc alloy  
Finish: Chrome, Pearl chrome, Nickel satin

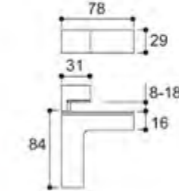

品名：F玻璃夹  
Name: F Glass clip

**TG104**

主要材质：国标锌合金  
表面处理：光铬、珍珠铬、拉丝镍  
Material: GB Zinc alloy  
Finish: Chrome, Pearl chrome, Nickel satin

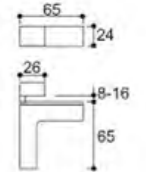

品名：F玻璃夹  
Name: F Glass clip

**TG105**

主要材质：国标锌合金  
表面处理：光铬、珍珠铬、拉丝镍  
Material: GB Zinc alloy  
Finish: Chrome, Pearl chrome, Nickel satin

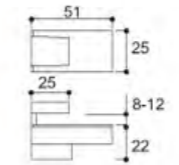

品名：玻璃夹  
Name: Glass clip

**TG106**

主要材质：国标锌合金  
表面处理：光铬、珍珠铬、拉丝镍  
Material: GB Zinc alloy  
Finish: Chrome, Pearl chrome, Nickel satin

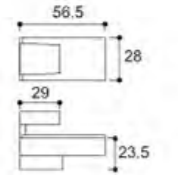

品名：玻璃夹  
Name: Glass clip

**TG107**

主要材质：国标锌合金  
表面处理：光铬、珍珠铬、拉丝镍  
Material: GB Zinc alloy  
Finish: Chrome, Pearl chrome, Nickel satin

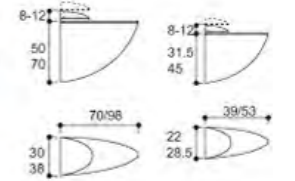

品名：鱼嘴夹  
Name: Fish-mouth clamp

**TG108**

主要材质：国标锌合金  
表面处理：光铬、珍珠铬、拉丝镍  
Material: GB Zinc alloy  
Finish: Chrome, Pearl chrome, Nickel satin

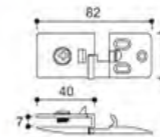

品名：玻璃合页  
Name: Glass hinge

**TG109**

主要材质：国标锌合金  
表面处理：光铬、珍珠铬、拉丝镍  
Material: GB Zinc alloy  
Finish: Chrome, Pearl chrome, Nickel satin

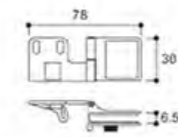

品名：玻璃门铰  
Name: Glass door hinge

**TG110**

主要材质：国标锌合金  
表面处理：光铬、珍珠铬、拉丝镍  
Material: GB Zinc alloy  
Finish: Chrome, Pearl chrome, Nickel satin

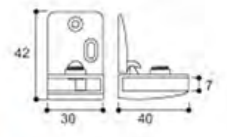

品名：玻璃合页  
Name: Glass hinge

**TG111**

主要材质：国标锌合金  
表面处理：光铬、珍珠铬、拉丝镍  
Material: GB Zinc alloy  
Finish: Chrome, Pearl chrome, Nickel satin



品名：屏风夹  
Name: Partition clamp  
**TG112**

主要材质：铝合金  
表面处理：沙白、沙银  
Material: Aluminum  
Finish: Sand white,  
Sand silver

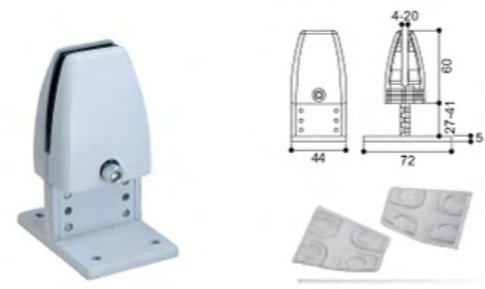

品名：屏风夹  
Name: Partition clamp  
**TG113**

主要材质：铝合金  
表面处理：沙白、沙银  
Material: Aluminum  
Finish: Sand white,  
Sand silver



品名：屏风夹  
Name: Partition clamp  
**TG114**

主要材质：铝合金  
表面处理：沙白、沙银  
Material: Aluminum  
Finish: Sand white,  
Sand silver

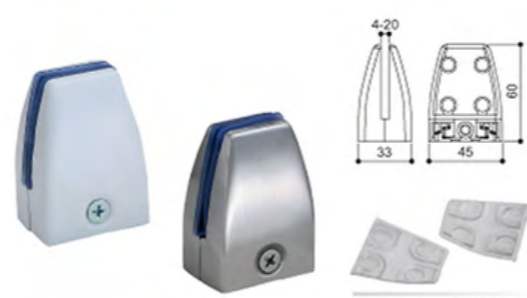

品名：屏风夹  
Name: Partition clamp  
**TG115**

主要材质：不锈钢  
表面处理：沙白、沙银  
Material: Stainless steel  
Finish: Sand white,  
Sand silver



品名：屏风夹  
Name: Partition clamp  
**TG116**

主要材质：锌合金、铝合金  
表面处理：沙白、沙银  
Material: Zinc alloy, Aluminum  
Finish: Sand white,  
Sand silver

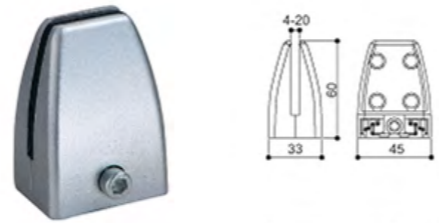

品名：屏风夹  
Name: Partition clamp  
**TG117**

主要材质：锌合金、铝合金  
表面处理：沙白、沙银  
Material: Zinc alloy, Aluminum  
Finish: Sand white,  
Sand silver

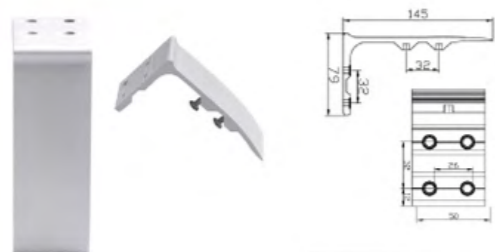

品名：屏风夹  
Name: Partition clamp  
**TG118**

主要材质：锌合金、铝合金  
表面处理：沙白、沙银  
Material: Zinc alloy, Aluminum  
Finish: Sand white,  
Sand silver



品名：屏风夹  
Name: Partition clamp  
**TG119**

主要材质：锌合金、铝合金  
表面处理：沙白、沙银  
Material: Zinc alloy, Aluminum  
Finish: Sand white,  
Sand silver





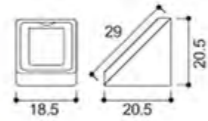

品名：塑料角码  
Name: Plastic connector

**PG001**

主要材质：ABS  
表面处理：白色、黑色、灰色、棕色  
Material: ABS  
Finish: White, Black, Grey, Brown

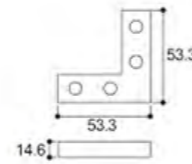

品名：7字角码  
Name: 7-Bracket

**PG002**

主要材质：ABS  
表面处理：黑色、白色、棕色、米黄色  
Material: ABS  
Finish: Black, White, Brown, Cream

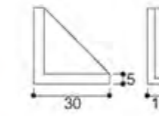

品名：角码  
Name: Bracket

**PG007**

主要材质：ABS  
表面处理：白色、灰色  
Material: ABS  
Finish: White, Grey

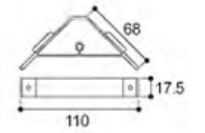

品名：连接件  
Name: Connector

**PG008**

主要材质：ABS  
表面处理：透明、白色  
Material: ABS  
Finish: Transparent, White

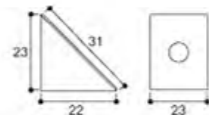

品名：塑料角码  
Name: Plastic connector

**PG003**

主要材质：ABS  
表面处理：白色、黑色、灰色、棕色  
Material: ABS  
Finish: White, Black, Grey, Brown

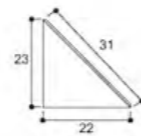

品名：塑料角码  
Name: Plastic connector

**PG004**

主要材质：ABS  
表面处理：白色、黑色、灰色、棕色  
Material: ABS  
Finish: White, Black, Grey, Brown

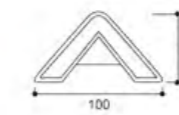

品名：连接件  
Name: Connecting piece

**PG009**

主要材质：塑料  
表面处理：白色、棕色、红色  
Material: Plastic  
Finish: White / Brown / Red

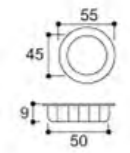

品名：装饰扣  
Name: Decorate button

**PG010**

主要材质：ABS  
表面处理：白色  
Material: ABS  
Finish: White

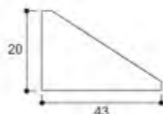
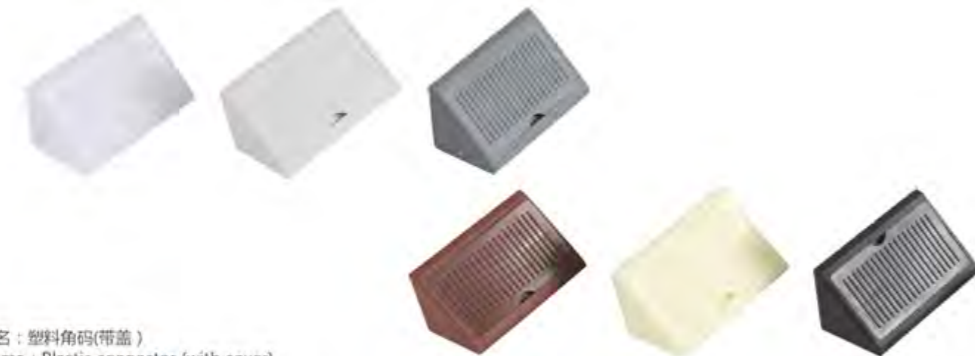

品名：塑料角码(带盖)  
Name: Plastic connector (with cover)

**PG005**

主要材质：ABS  
表面处理：白色、黑色、灰色、棕色  
Material: ABS  
Finish: White, Black, Grey, Brown

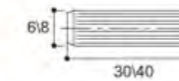

品名：木棒(直纹、斜纹)  
Name: Wood

**PG011**

材质：木  
表面处理：原木  
Material: Wood  
Finish: Wood

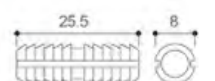

品名：井板肖  
Name: Connecting pin

**PG012**

材质：尼龙、聚乙烯  
表面处理：棕色、白色、透明  
Material: Nylon, Polyethylene  
Finish: Brown, White, Transparent

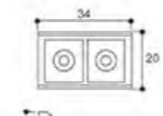

品名：塑料角码  
Name: Plastic connector

**PG006**

主要材质：ABS  
表面处理：白色、黑色、灰色、棕色  
Material: ABS  
Finish: White, Black, Grey, Brown

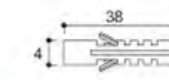

品名：膨胀钉  
Name: Expansion pin

**PG013**

主要材质：尼龙  
表面处理：白色、灰色  
Material: Nylon  
Finish: White, Grey

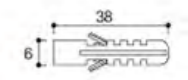

品名：膨胀胶塞  
Name: Expansion plastic plugs

**PG014**

主要材质：尼龙  
表面处理：白色、灰色  
Material: Nylon  
Finish: White, Grey

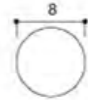

主要材质: 塑料  
表面处理: 白色、灰色、棕色、透明  
Material: Plastic  
Finish: White, Grey, Brown, Transparent

品名: 自粘防撞粒  
Name: Proof fitting

**PG015**

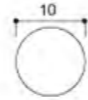

主要材质: 塑料  
表面处理: 白色、灰色、棕色、透明  
Material: Plastic  
Finish: White, Grey, Brown, Transparent

品名: 自粘防撞粒  
Name: Proof fitting

**PG016**



主要材质: 软克力  
表面处理: 黑色、白色、棕色、透明  
Material: Soft plastic  
Finish: Black, White, Brown, Transparent

品名: 防撞软垫  
Name: Anti-collision mat

**PG017**



主要材质: 软克力  
表面处理: 透明  
Material: Soft plastic  
Finish: Transparent

品名: 防尘垫  
Name: Floor mat

**PG018**



主要材质: 软克力  
表面处理: 透明  
Material: Soft plastic  
Finish: Transparent

品名: 软地垫  
Name: Soft floor mat

**PG023**



主要材质: 软克力  
表面处理: 透明  
Material: Soft plastic  
Finish: Transparent

品名: 玻璃吸盘  
Name: Glass sucker

**PG024**



主要材质: 软克力  
表面处理: 透明  
Material: Soft plastic  
Finish: Transparent

品名: 介钱  
Name: Washer

**PG025**



主要材质: 软克力  
表面处理: 透明  
Material: Soft plastic  
Finish: Transparent

品名: 软地垫  
Name: Soft floor mat

**PG026**



主要材质: 塑料  
表面处理: 白、灰、棕  
Material: Plastic  
Finish: White, Grey, Brown

品名: 3厘角钮  
Name: 3mm Corner button

**PG027**



主要材质: 塑料  
表面处理: 白、灰、棕  
Material: Plastic  
Finish: White, Grey, Brown

品名: 5厘角钮  
Name: 5mm Corner button

**PG028**

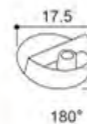

主要材质: 塑料  
表面处理: 白、灰、棕  
Material: Plastic  
Finish: White, Grey, Brown

品名: 3厘角钮  
Name: 3mm Corner button

**PG029**

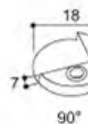

主要材质: 塑料  
表面处理: 白、灰、棕  
Material: Plastic  
Finish: White, Grey, Brown

品名: 5厘角钮  
Name: 5mm Corner button

**PG030**

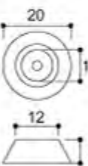

主要材质: 软克力  
表面处理: 透明  
Material: Soft plastic  
Finish: Transparent

品名: 20软脚垫  
Name: 20 Mild floor mat

**PG019**

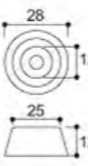

主要材质: 软克力  
表面处理: 黑色、透明  
Material: Soft plastic  
Finish: Black, Transparent

品名: 28软脚垫  
Name: 28 Mild floor mat

**PG020**



主要材质: 软克力  
表面处理: 白色、黑色、透明  
Material: Soft plastic  
Finish: White, Black, Transparent

品名: 18软脚垫  
Name: 18 Mild floor mat

**PG021**



主要材质: 软克力  
表面处理: 黑色、透明  
Material: Soft plastic  
Finish: Black, Transparent

品名: 18加高透明垫  
Name: 18 highTransparent pad

**PG022**

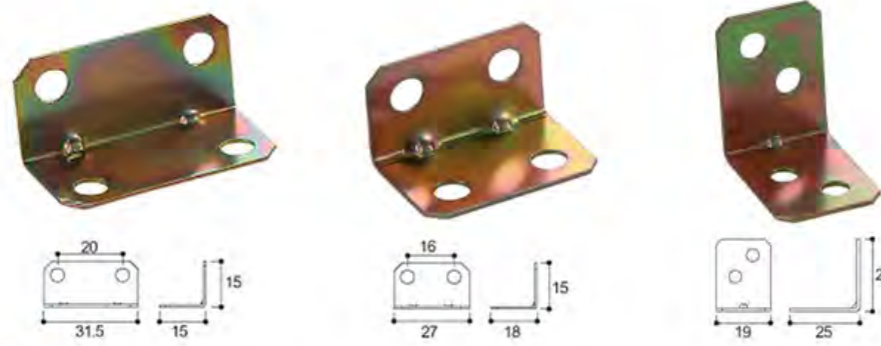

品名：角码  
Name：Angle piece

**PG031**

主要材质：铁  
表面处理：镀锌、彩  
Material：Iron  
Finish：Zinc, Color



品名：角码  
Name：Angle piece

**PG038**

主要材质：铁  
表面处理：喷白漆  
Material：Iron  
Finish：White paint



品名：角码  
Name：Angle piece

**PG039**

主要材质：铁  
表面处理：喷白漆  
Material：Iron  
Finish：White paint



品名：角码  
Name：Angle piece

**PG032**

主要材质：不锈钢  
表面处理：镀镍  
Material：Stainless steel  
Finish：Nickel

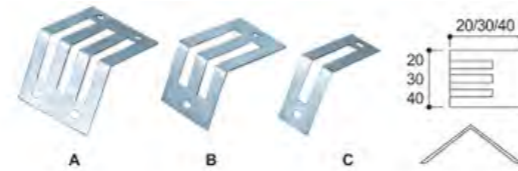

品名：角码  
Name：Angle piece

**PG033**

材质：铁  
表面处理：镀锌  
Material：Iron  
Finish：Zinc



品名：角码  
Name：Angle piece

**PG040**

主要材质：铁  
表面处理：镀锌  
Material：Iron  
Finish：Zinc

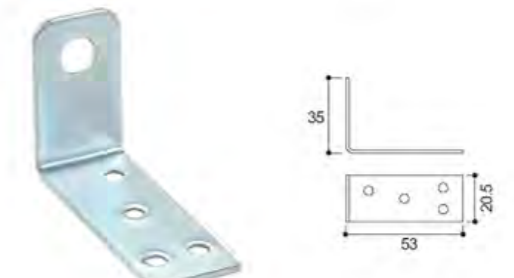

品名：角码  
Name：Angle piece

**PG041**

主要材质：铁  
表面处理：镀锌  
Material：Iron  
Finish：Zinc

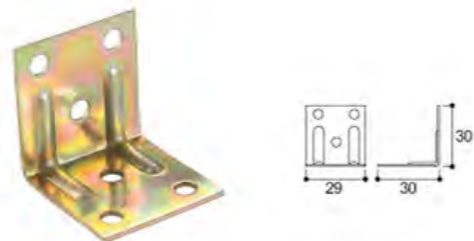

品名：角码  
Name：Angle piece

**PG034**

主要材质：铁  
表面处理：镀锌  
Material：Iron  
Finish：Zinc

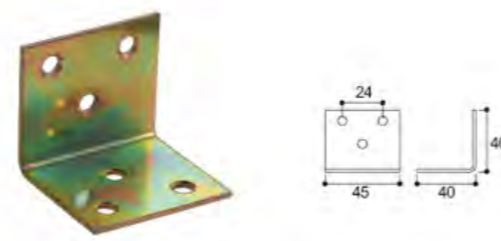

品名：角码  
Name：Angle piece

**PG035**

主要材质：铁  
表面处理：镀锌、彩  
Material：Iron  
Finish：Zinc, Color



品名：连接扣  
Name：Connection buckle

**PG042**

主要材质：铁  
表面处理：镀锌、彩  
Material：Iron  
Finish：Zinc, Color



品名：连接角码  
Name：Connecting bracket

**PG043**

主要材质：铁  
表面处理：镀锌、彩  
Material：Iron  
Finish：Zinc, Color



品名：角码  
Name：Angle piece

**PG036**

主要材质：ABS+铁  
表面处理：白色、黑色、灰色、棕色  
Material：ABS+Iron  
Finish：White, Black, Grey, Brown

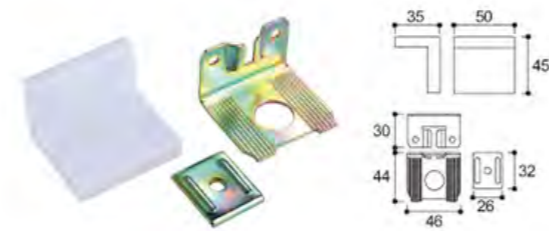

品名：角码  
Name：Angle piece

**PG037**

主要材质：塑料+铁  
表面处理：白色、灰色  
Material：Plastic+Iron  
Finish：White, Grey

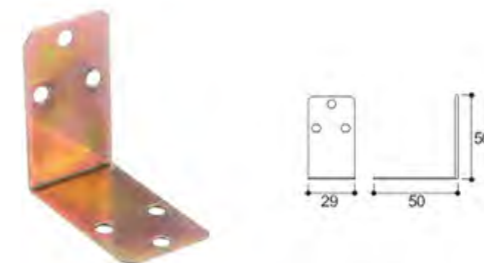

品名：连接角码  
Name：Connecting bracket

**PG044**

主要材质：铁  
表面处理：镀锌  
Material：Iron  
Finish：Zinc



品名：连接角码  
Name：Connecting bracket

**PG045**

主要材质：铁  
表面处理：镀锌、彩  
Material：Iron  
Finish：Zinc, Color



品名：2寸挂角  
Name: 2" Angle pieces  
**PG046**

主要材质：铁  
表面处理：镀锌、古铜  
Material: Iron  
Finish: Zinc, Bronze



品名：连接角码  
Name: Connecting bracket  
**PG047**

主要材质：国标锌合金  
表面处理：古铜、亮光、珍珠铬  
Material: Iron, Light  
Finish: Bronze, Light, Pearl chrome



品名：压片  
Name: Tableting  
**PG054**

主要材质：铁  
表面处理：镀锌、镍  
Material: Iron  
Finish: Zinc, Nickel



品名：压片  
Name: Tableting  
**PG055**

主要材质：铁  
表面处理：镀锌、镍  
Material: Iron  
Finish: Zinc, Nickel



品名：连接角码  
Name: Connecting bracket  
**PG048**

主要材质：铁  
表面处理：镀锌  
Material: Iron  
Finish: Zinc



品名：连接角码  
Name: Connecting bracket  
**PG049**

主要材质：铁  
表面处理：镀锌  
Material: Iron  
Finish: Zinc



品名：7字锁扣  
Name: 7-shaped lock catch  
**PG056**

主要材质：铁  
表面处理：镀锌、镍  
Material: Iron  
Finish: Zinc, Nickel



品名：锁扣片  
Name: Lock buckle  
**PG057**

主要材质：铁  
表面处理：镀锌、镍  
Material: Iron  
Finish: Zinc, Nickel



品名：连接片  
Name: Connecting pieces  
**PG050**

主要材质：铁  
表面处理：镀锌、镍  
Material: Iron  
Finish: Zinc, Nickel



品名：连接片  
Name: Connecting pieces  
**PG051**

主要材质：铁  
表面处理：镀锌、镍  
Material: Iron  
Finish: Zinc, Nickel



品名：吊片  
Name: Suspension pieces  
**PG058**

主要材质：铁  
表面处理：镀锌、彩  
Material: Iron  
Finish: Zinc, Color



品名：吊片  
Name: Suspension pieces  
**PG059**

主要材质：铁  
表面处理：镀锌、彩  
Material: Iron  
Finish: Zinc, Color



品名：办公台吊码  
Name: Office desk hanger  
**PG052**

主要材质：铁  
表面处理：喷白漆  
Material: Iron  
Finish: White paint



品名：挂件  
Name: Pendant  
**PG053**

主要材质：铁  
表面处理：喷白漆  
Material: Iron  
Finish: White paint



品名：铁片码  
Name: Iron pieces  
**PG060**

主要材质：铁  
表面处理：镀锌、彩  
Material: Iron  
Finish: Zinc, Color



品名：铁片  
Name: Iron pieces  
**PG061**

主要材质：铁  
表面处理：镀锌、彩  
Material: Iron  
Finish: Zinc, Color

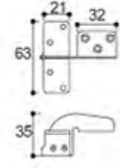

品名：台铰  
Name: Dining-table hinge

**PG062**

主要材质：铁  
表面处理：镀锌、彩  
Material: Iron  
Finish: Zinc, Color

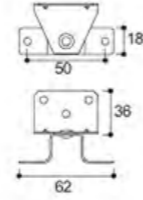

品名：四方角码  
Name: Square indices

**PG063**

主要材质：铁  
表面处理：镀锌、彩  
Material: Iron  
Finish: Zinc, Color

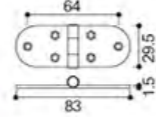

品名：铁翻铰  
Name: Turning hinge

**PG064**

主要材质：铁  
表面处理：镀锌  
Material: Iron  
Finish: Zinc

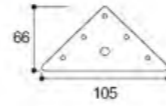

品名：大三角铁片  
Name: Big L-iron

**PG065**

主要材质：铁  
表面处理：镀锌、彩  
Material: Iron  
Finish: Zinc, Color

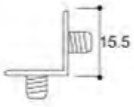

品名：多功能角码  
Name: Flexo indices

**PG066**

主要材质：铁  
表面处理：镀锌、彩  
Material: Iron  
Finish: Zinc, Color



品名：镜后紧固片  
Name: Mirror-back fastening piece

**PG067**

主要材质：铁  
表面处理：镀锌、黑色  
Material: Iron  
Finish: Zinc, Black

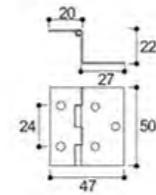

品名：曲铰  
Name: Bent hinge

**PG068**

主要材质：铁  
表面处理：镀锌、彩  
Material: Iron  
Finish: Zinc, Color

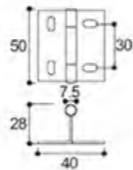
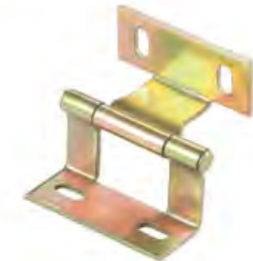

品名：屏风铰  
Name: Screen hinge

**PG069**

主要材质：铁  
表面处理：镀锌、彩  
Material: Iron  
Finish: Zinc, Color

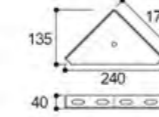

品名：床角撑  
Name: Bed corner support

**PG070**

主要材质：铁  
表面处理：黑漆、白漆  
Material: Iron  
Finish: Black Paint/ White Paint

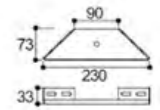

品名：床角撑  
Name: Bed corner support

**PG071**

主要材质：铁  
表面处理：黑漆、白漆  
Material: Iron  
Finish: Black Paint/ White Paint

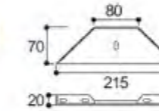

品名：床角撑  
Name: Bed corner support

**PG072**

主要材质：铁  
表面处理：镀锌、镍  
Material: Iron  
Finish: Zinc, Nickel

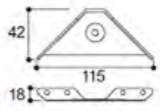

品名：床角撑  
Name: Bed corner support

**PG073**

主要材质：铁  
表面处理：镀锌、镍  
Material: Iron  
Finish: Zinc, Nickel

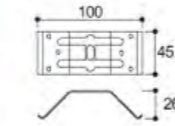

品名：塞角  
Name: Block

**PG074**

主要材质：铁  
表面处理：镀锌、镍  
Material: Iron  
Finish: Zinc, Nickel

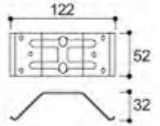

品名：塞角  
Name: Block

**PG075**

主要材质：铁  
表面处理：镀锌、镍  
Material: Iron  
Finish: Zinc, Nickel

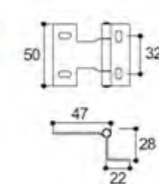

品名：屏风铰  
Name: Screen hinge

**PG076**

主要材质：铁  
表面处理：镀锌、彩  
Material: Iron  
Finish: Zinc, Color

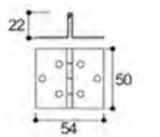

品名：曲铰  
Name: Bent hinge

**PG077**

主要材质：铁  
表面处理：镀锌、彩  
Material: Iron  
Finish: Zinc, Color

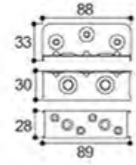

品名：螺丝床铰  
Name: Screw bed  
**PG078**

主要材质：铁  
表面处理：镀锌、彩  
Material: Iron  
Finish: Zinc, Color

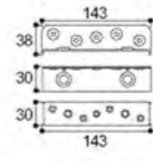

品名：螺丝床铰  
Name: Screw bed  
**PG079**

主要材质：铁  
表面处理：镀锌、彩  
Material: Iron  
Finish: Zinc, Color

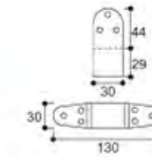

品名：弧形床仔铰  
Name: Arc bed hinge  
**PG086**

主要材质：铁  
表面处理：镀锌、彩  
Material: Iron  
Finish: Zinc, Color

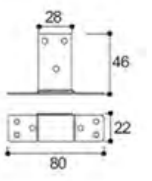
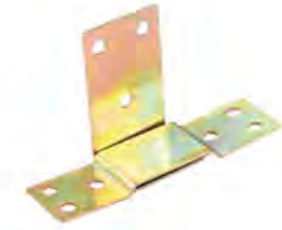

品名：床仔铰  
Name: Bed hinges  
**PG087**

主要材质：铁  
表面处理：镀锌、彩  
Material: Iron  
Finish: Zinc, Color

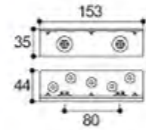

品名：螺丝床铰  
Name: Screw bed  
**PG080**

主要材质：铁  
表面处理：镀锌、彩  
Material: Iron  
Finish: Zinc, Color

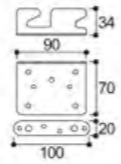

品名：床铰  
Name: Bed hangers  
**PG081**

主要材质：铁  
表面处理：镀锌、彩  
Material: Iron  
Finish: Zinc, Color

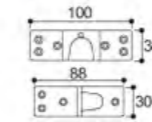

品名：床仔铰  
Name: Bed hinges  
**PG088**

主要材质：铁  
表面处理：镀锌、彩  
Material: Iron  
Finish: Zinc, Color

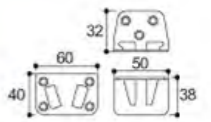

品名：挂钩片  
Name: Hook  
**PG089**

主要材质：铁  
表面处理：镀锌、彩  
Material: Iron  
Finish: Zinc, Color

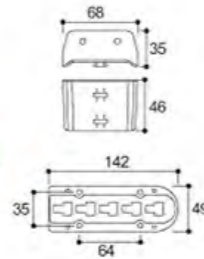

品名：升降床铰  
Name: Elevation bed hinge  
**PG082**

主要材质：铁  
表面处理：镀锌、彩  
Material: Iron  
Finish: Zinc, Color

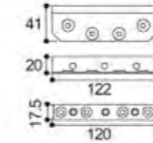

品名：5寸美式床铰  
Name: 5" English-style bed hinge  
**PG083**

主要材质：铁  
表面处理：镀锌、彩  
Material: Iron  
Finish: Zinc, Color

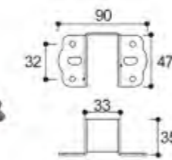

品名：床铰  
Name: Bed hinge  
**PG090**

主要材质：铁  
表面处理：镀锌、彩  
Material: Iron  
Finish: Zinc, Color

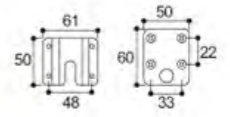

品名：连接挂片  
Name: Connecting pieces  
**PG091**

主要材质：铁  
表面处理：镀锌、彩  
Material: Iron  
Finish: Zinc, Color

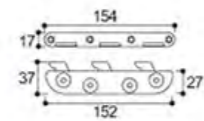

品名：床挂件  
Name: Bed hangers  
**PG084**

主要材质：铁  
表面处理：镀锌、彩  
Material: Iron  
Finish: Zinc, Color

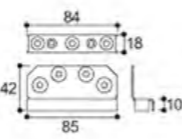

品名：螺丝床铰  
Name: Screw bed  
**PG085**

主要材质：铁  
表面处理：镀锌、彩  
Material: Iron  
Finish: Zinc, Color

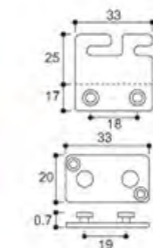

品名：儿童床挂件  
Name: Child's bed hanger  
**PG092**

主要材质：铁  
表面处理：镀锌、彩  
Material: Iron  
Finish: Zinc, Color

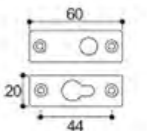

品名：挂挂片  
Name: Hanging pieces  
**PG093**

主要材质：铁  
表面处理：镀锌、彩  
Material: Iron  
Finish: Zinc, Color



品名：十字铰  
Name: Cross hinge  
**PG094**

主要材质：国标锌合金+铁  
表面处理：镀铬、镀金、镍银  
Material: GB Zinc alloy + Iron  
Finish: Chrome, Gold, Nickel



品名：十字铰  
Name: Cross hinge  
**PG095**

主要材质：国标锌合金  
表面处理：仿金  
Material: GB Zinc alloy  
Finish: Imitation gold



品名：十字铰  
Name: Cross hinge  
**PG096**

主要材质：国标锌合金  
表面处理：仿金  
Material: GB Zinc alloy  
Finish: Imitation gold



品名：暗藏铰  
Name: Concealed secret hinge  
**PG097**

主要材质：铁+塑料  
表面处理：棕色  
Material: Iron+Plastic  
Finish: Brown



品名：餐台铜套  
Name: Dining-table copper bush  
**PG098**

主要材质：铜  
表面处理：原色  
Material: Brass  
Finish: Primary color



品名：餐台铜套  
Name: Dining-table copper bush  
**PG099**

主要材质：铜  
表面处理：原色  
Material: Brass  
Finish: Primary color



品名：台面铰  
Name: Table-board hinge  
**PG100**

主要材质：国标锌合金  
表面处理：镀镍、青古铜  
Material: GB Zinc alloy  
Finish: Nickel, Antique copper



品名：翻板铰  
Name: Turning hinge  
**PG101**

主要材质：国标锌合金  
表面处理：金色、银色  
Material: GB Zinc alloy  
Finish: Gold, Silver



品名：转盘  
Name: Turntable  
**PG102**

主要材质：铁  
表面处理：白色、黑色  
Material: Iron  
Finish: White, Black



品名：转盘  
Name: Turntable  
**PG103**

主要材质：铁  
表面处理：白色、黑色  
Material: Iron  
Finish: White, Black



品名：转盘  
Name: Turntable  
**PG104**

主要材质：铁  
表面处理：白色、黑色  
Material: Iron  
Finish: White, Black



品名：转盘  
Name: Turntable  
**PG105**

主要材质：铁  
表面处理：白色、黑色  
Material: Iron  
Finish: White, Black



品名：转盘  
Name: Turntable  
**PG106**

主要材质：铁  
表面处理：白色、黑色  
Material: Iron  
Finish: White, Black



品名：转盘  
Name: Turntable  
**PG107**

主要材质：铁  
表面处理：白色、黑色  
Material: Iron  
Finish: White, Black



品名：转盘  
Name: Turntable  
**PG108**

主要材质：铝合金  
表面处理：银色、黑色  
Material: Aluminium alloy  
Finish: Silver



品名：转盘  
Name: Turntable  
**PG109**

主要材质：塑料  
表面处理：黑色  
Material: Plastic  
Finish: Black



品名：广告螺丝  
Name: Advertising screw

**PG110**

材质：铁  
表面处理：拉丝、亮光  
Material: Iron  
Finish: Drawbench, High gloss

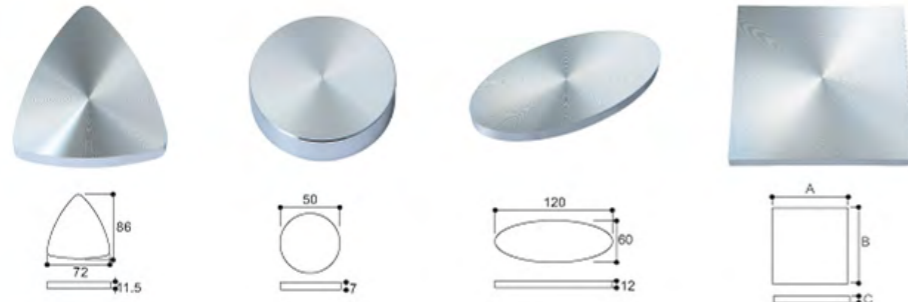

品名：铝饼  
Name: Aluminum piece

**PG111**

(AxB): 100x100  
90x90  
80x80  
70x70  
60x60  
(C): 9.5  
螺丝位: M6/M8/M10  
主要材质：铝  
表面处理：氧化  
Material: Aluminum  
Finish: Oxidation



品名：大葫芦杯  
Name: Big calabash cup

**PG112**

主要材质：国际锌合金  
表面处理：光铬  
Material: GB Zinc alloy  
Finish: Chrome



品名：小葫芦杯  
Name: Small calabash cup

**PG113**

主要材质：国际锌合金  
表面处理：光铬  
Material: GB Zinc alloy  
Finish: Chrome



品名：二合一脚  
Name: Two-in-one leg

**PG114**

主要材质：国际锌合金  
表面处理：光铬  
Material: GB Zinc alloy  
Finish: Chrome



品名：葫芦(全通/半通)  
Name: Calabash(all-pass / semi-latus rectum)

**PG115**

规格(Size): M4 / M6  
主要材质：国际锌合金  
表面处理：金色、银色  
Material: GB Zinc alloy  
Finish: Gold, Silver







品名：趟门轮  
Name: Sliding door wheel  
**YG001**

主要材质：国标锌合金+铜  
表面处理：镀铬  
Material: GB Zinc alloy  
+Brass  
Finish: Chrome



品名：趟门轮  
Name: Sliding door wheel  
**YG002**

主要材质：国标锌合金+铜  
表面处理：镀铬  
Material: GB Zinc alloy  
+Brass  
Finish: Chrome



品名：移门轮  
Name: Sliding door wheel  
**YG010**

主要材质：铁+尼龙  
表面处理：镀铬  
Material: Iron+Nylon  
Finish: Chrome



品名：移门轮  
Name: Sliding door wheel  
**YG003**

主要材质：铁+尼龙  
表面处理：黑色+白色  
Material: Iron+Nylon  
Finish: Black+White



品名：趟门轮  
Name: Sliding door wheel  
**YG004**

主要材质：不锈钢+塑料  
表面处理：拉丝  
Material: Stainless steel  
+Plastic  
Finish: Stain



品名：移门轮  
Name: Sliding door wheel  
**YG009**

主要材质：铁+尼龙  
表面处理：黑色+白色  
Material: Iron+Nylon  
Finish: Black+White



品名：移门轮  
Name: Sliding door wheel  
**YG011**

主要材质：铁+尼龙  
表面处理：黑色+白色  
Material: Iron+Nylon  
Finish: Black+White



品名：移门轮  
Name: Sliding door wheel  
**YG012**

主要材质：铁+尼龙  
表面处理：黑色+白色  
Material: Iron+Nylon  
Finish: Black+White



品名：柜门顶珠  
Name: Cabinet door pearl  
**YG005**

主要材质：塑料+铁  
表面处理：黑色+白色  
Material: Plastic+Iron  
Finish: Black+White

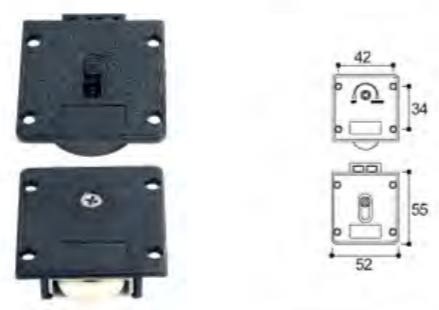

品名：柜门顶珠  
Name: Cabinet door pearl  
**YG006**

主要材质：塑料+铁  
表面处理：黑色+白色  
Material: Plastic+Iron  
Finish: Black+White



品名：移门轮  
Name: Sliding door wheel  
**YG013**

材质：铁  
表面处理：黑色  
Material: Iron  
Finish: Black



品名：移门轮  
Name: Sliding door wheel  
**YG014**

材质：铁  
表面处理：黑色  
Material: Iron  
Finish: Black



品名：顶珠  
Name: Pearl  
**YG007**

主要材质：塑料+铁  
表面处理：咖啡色  
Material: Plastic+Iron  
Finish: Coffee



品名：红顶珠  
Name: Red pearl  
**YG008**

主要材质：塑料+铁  
表面处理：棕色  
Material: Plastic+Iron  
Finish: Brown



品名：移门轮  
Name: Sliding door wheel  
**YG015**

材质：铁  
表面处理：黑色  
Material: Iron  
Finish: Black



品名：移门轮  
Name: Sliding door wheel  
**YG016**

材质：铁  
表面处理：镀锌  
Material: Iron  
Finish: Zinc

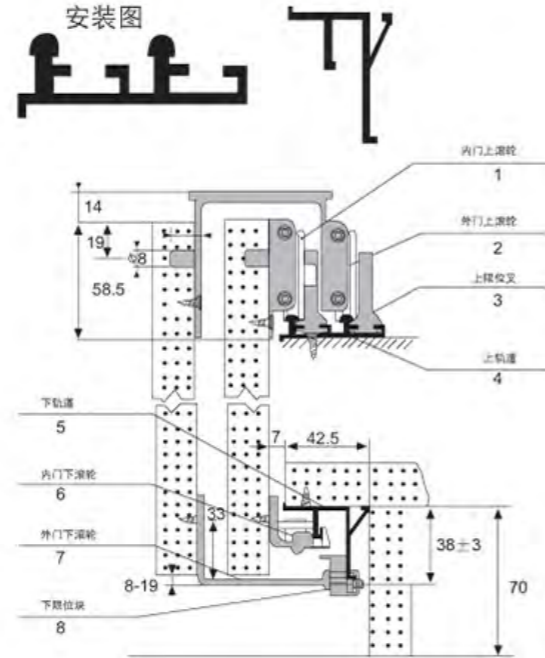

品名：重型移门轮  
Name: Heavy-duty door Wheel

材质：铁  
表面处理：黑色  
Material: Iron  
Finish: Black

**YG017** MING XIN



品名：移门轨  
Name: Sliding door track

**YG018**

材质：铝合金  
Material: Aluminum  
拉丝 哑光 砂光 亮光

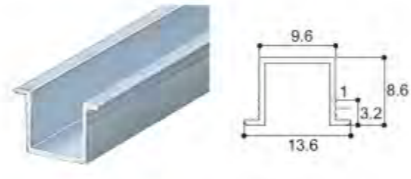

品名：移门轨  
Name: Sliding door track

**YG019**

材质：铝合金  
Material: Aluminum  
拉丝 哑光 砂光 亮光



品名：移门轨  
Name: Sliding door track

**YG020**

材质：铝合金  
Material: Aluminum  
拉丝 哑光 砂光 亮光

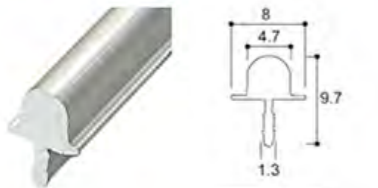

品名：移门轨  
Name: Sliding door track

**YG021**

材质：铝合金  
Material: Aluminum  
拉丝 哑光 砂光 亮光

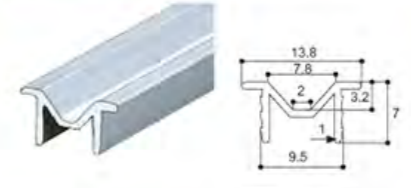

品名：移门轨  
Name: Sliding door track

**YG022**

材质：铝合金  
Material: Aluminum  
拉丝 哑光 砂光 亮光



品名：移门轨  
Name: Sliding door track

**YG023**

材质：铝合金  
Material: Aluminum  
拉丝 哑光 砂光 亮光



**YG024**



**YG025**



**YG026**



**YG027**



**YG028**



品名：衣管托  
Name: Wardrobe rail support

**YG029**

主要材质：国标锌合金  
表面处理：镀镍、镀铬  
Material: GB zinc alloy  
Finish: Nickel, Chrome

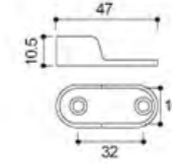

品名：衣管托  
Name: Wardrobe rail support

**YG030**

主要材质：国标锌合金  
表面处理：镀镍、镀铬  
Material: GB zinc alloy  
Finish: Nickel, Chrome

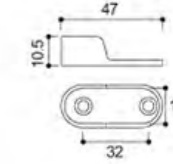

品名：衣管托  
Name: Wardrobe rail support

**YG031**

主要材质：国标锌合金  
表面处理：镀镍、镀铬  
Material: GB zinc alloy  
Finish: Nickel, Chrome

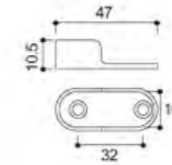

品名：衣管托  
Name: Wardrobe rail support

**YG032**

主要材质：国标锌合金  
表面处理：镀镍、镀铬  
Material: GB zinc alloy  
Finish: Nickel, Chrome

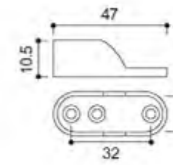

品名：衣管托  
Name: Wardrobe rail support

**YG033**

主要材质：国标锌合金  
表面处理：镀镍、镀铬  
Material: GB zinc alloy  
Finish: Nickel, Chrome

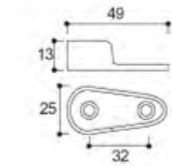

品名：衣管托  
Name: Wardrobe rail support

**YG034**

主要材质：国标锌合金  
表面处理：镀镍、镀铬  
Material: GB zinc alloy  
Finish: Nickel, Chrome

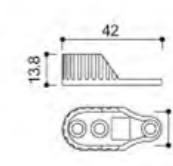

品名：衣管托  
Name: Wardrobe rail support

**YG035**

主要材质：国标锌合金  
表面处理：镀镍、镀铬  
Material: GB zinc alloy  
Finish: Nickel, Chrome

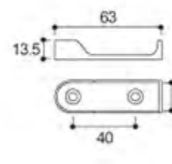

品名：衣管托  
Name: Wardrobe rail support

**YG036**

主要材质：国标锌合金  
表面处理：镀镍、镀铬  
Material: GB zinc alloy  
Finish: Nickel, Chrome

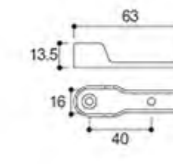

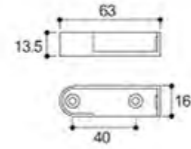

品名：衣管托  
Name: Wardrobe rail support  
**YG037**

主要材质：国标锌合金  
表面处理：香槟  
Material: GB zinc alloy  
Finish: Champagne

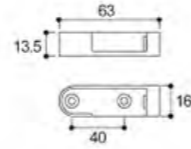

品名：衣管托  
Name: Wardrobe rail support  
**YG038**

主要材质：国标锌合金  
表面处理：青古  
Material: GB zinc alloy  
Finish: Antique brass

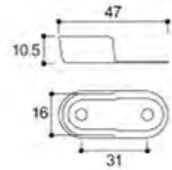

品名：衣管托  
Name: Wardrobe rail support  
**YG039**

主要材质：铁  
表面处理：镀镍  
Material: Iron  
Finish: Nickel

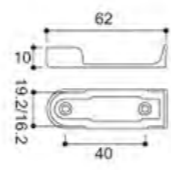

品名：衣管托  
Name: Wardrobe rail support  
**YG040**

主要材质：铁  
表面处理：镀镍  
Material: Iron  
Finish: Nickel

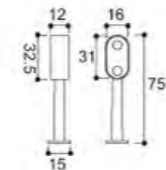

品名：倒吊衣托(半通)  
Name: Suspension alloy pipes(half-pass)  
**YG041**

主要材质：国标锌合金  
表面处理：光络、拉丝镍  
Material: GB zinc alloy  
Finish: Chrome, Nickel satin

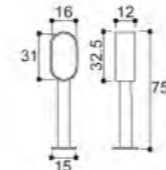

品名：倒吊衣托(全通)  
Name: Suspension alloy pipes(full-pass)  
**YG042**

主要材质：国标锌合金  
表面处理：光络、拉丝镍  
Material: GB zinc alloy  
Finish: Chrome, Nickel satin

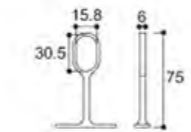

品名：倒吊衣托(全通)  
Name: Suspension alloy pipes(full-pass)  
**YG043**

主要材质：国标锌合金  
表面处理：光络、拉丝镍  
Material: GB zinc alloy  
Finish: Chrome, Nickel satin

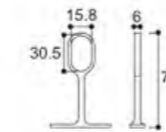

品名：倒吊衣托(全通)  
Name: Suspension alloy pipes(full-pass)  
**YG044**

主要材质：国标锌合金  
表面处理：光络、拉丝镍  
Material: GB zinc alloy  
Finish: Chrome, Nickel satin

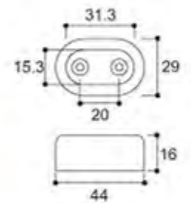

品名：扁管衣通座  
Name: Flat wardrobe tube seat  
**YG045**

主要材质：国标锌合金  
表面处理：光络、珍珠金  
Material: GB zinc alloy  
Finish: Chrome, Pearl gold

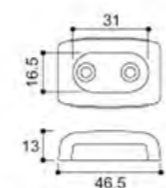

品名：扁管衣通座  
Name: Flat wardrobe tube seat  
**YG046**

主要材质：ABS  
表面处理：白、灰、红、黑  
Material: ABS  
Finish: White, grey, red, black

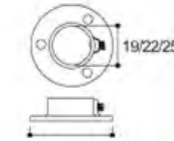

品名：法兰座  
Name: Flanged base  
**YG047**

主要材质：国标锌合金  
表面处理：镀镍、镀铬  
Material: GB zinc alloy  
Finish: Nickel, Chrome

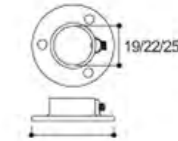

品名：法兰座  
Name: Flanged base  
**YG048**

主要材质：国标锌合金  
表面处理：镀镍、镀铬  
Material: GB zinc alloy  
Finish: Nickel, Chrome

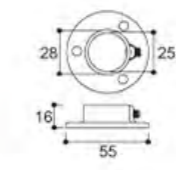

品名：法兰座  
Name: Flanged base  
**YG049**

主要材质：铁  
表面处理：镀镍  
Material: Iron  
Finish: Nickel

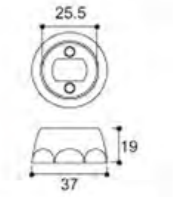

品名：球形法兰  
Name: Spherical flange  
**YG050**

主要材质：国标锌合金  
表面处理：光络、拉丝镍  
Material: GB zinc alloy  
Finish: Chrome, Nickel satin

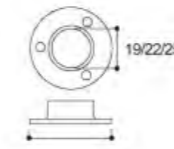

品名：法兰座  
Name: Flanged base  
**YG051**

主要材质：铁  
表面处理：镀镍  
Material: Iron  
Finish: Nickel

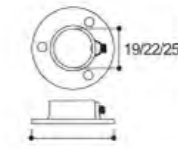

品名：法兰座  
Name: Flanged base  
**YG052**

主要材质：铁  
表面处理：镀镍  
Material: Iron  
Finish: Nickel

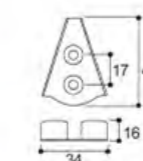

品名：V托  
Name: V support  
**YG053**

主要材质：铁  
表面处理：镀锌、彩  
Material: Iron  
Finish: Zinc, Color

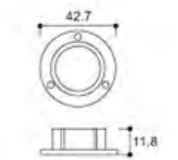

品名：塑料法兰座  
Name: Plastic Flanged base  
**YG054**

主要材质：塑料  
表面处理：黑、白、棕、黄  
Material: Plastic  
Finish: Black / White / Brown / Yellow

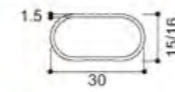
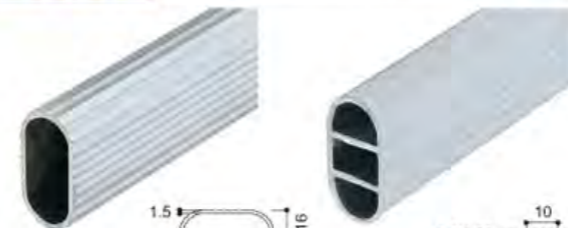

品名：扁管  
Name: Flat tube  
**YG055**

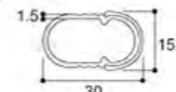
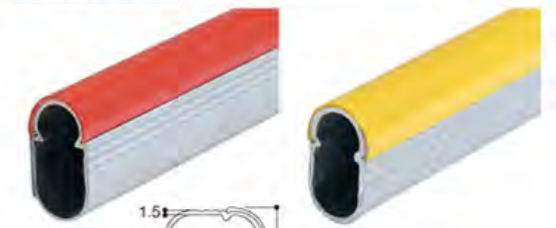
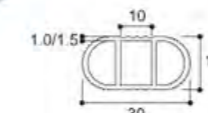

主要材质：铝  
表面处理：银色、金色  
Material: Aluminum  
Finish: Silver, gold



品名：衣柜推拉镜轨道  
Name: Wardrobe sliding-mirror track

**YG056**

规格：350mm/400mm/450mm  
Size: 350mm/400mm/450mm

材质：冷轧钢板  
表面处理：黑色  
Material: Cold-rolled steel  
Finish: Black

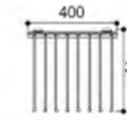
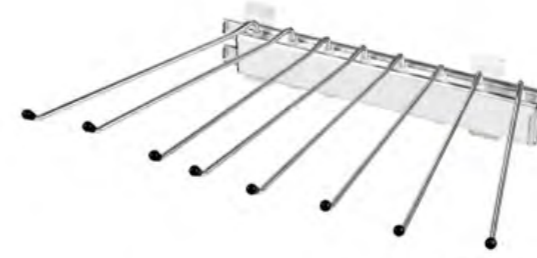

品名：活动西裤架、毛巾架  
Name: Pulls the clothes rack, Towel rack

**YG058**

主要材质：冷轧钢+ABS  
表面处理：镀镍  
Material: Cold-rolled steel+ABS  
Finish: Nickel plated

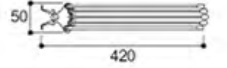

品名：活动西裤架  
Name: Pulls the clothes rack

**YG059**

主要材质：冷轧钢+ABS  
表面处理：镀镍  
Material: Cold-rolled steel+ABS  
Finish: Nickel plated



品名：旋转圆/角直角定位推拉镜  
Name: Rotary circle/angle right angle positioning sliding mirror

**YG057**

规格WxDxH(mm)	标准配置	铝材表面	备注
1200x350	27mm 定位镜轨	哑光 亮光/白橡木 红胡桃/香樟木 拉丝香槟/拉丝橡木红 拉丝铁灰	镜片贴膜
1100x350	35mm 定位镜轨		圆角
1000x350	27mm 定位镜轨	哑光	可选镜片贴膜
1200x350	27mm 定位镜轨		直角
1100x350	27mm 定位镜轨		

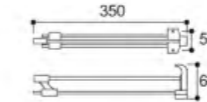

品名：伸缩衣架  
Name: Telescopic clothes rack

**YG060**

规格(Size): 12" / 14" / 16"  
主要材质：冷轧钢+ABS  
表面处理：镀镍  
Material: Cold-rolled steel+ABS  
Finish: Nickel plated

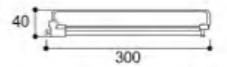

品名：伸缩衣架  
Name: Telescopic clothes rack

**YG061**

规格(Size): 12" / 14" / 16"  
主要材质：冷轧钢+ABS  
表面处理：镀镍  
Material: Cold-rolled steel+ABS  
Finish: Nickel plated



品名：可拉式领带架  
Name: Telescopic clothes rack

**YG062**

主要材质：冷轧钢+ABS  
表面处理：镀镍  
Material: Cold-rolled steel+ABS  
Finish: Nickel plated



品名：阻尼裤架  
Name: Damping frame pants

**YG063**

主要材质：铝+ABS  
表面处理：白色、黑色  
Material: Aluminum+ABS  
Finish: White, Black

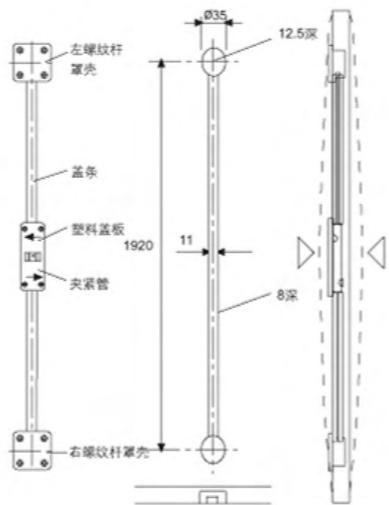
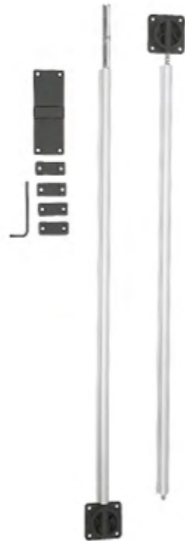
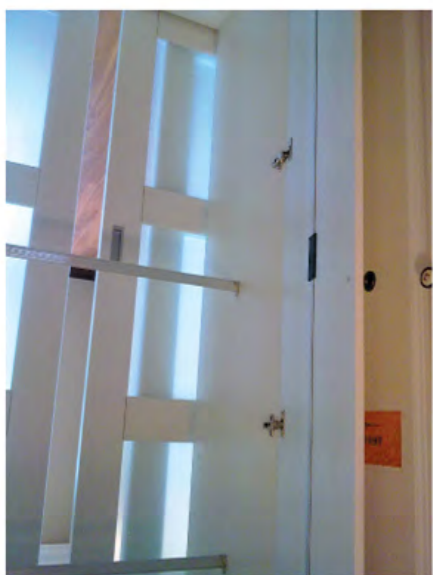

品名：衣柜矫正器  
Name: Wardrobe straightener

YG064

主要材质：铁、塑料、铝合金  
表面处理：镀锌、镀铬  
Material: Iron, Plastic, Aluminum  
Finish: Nickel, Chrome



品名：侧翻床铰  
Name: Side-tilting bed hinge

YG065

主要材质：铁  
表面处理：白色  
Material: Iron  
Finish: White



品名：正翻床铰  
Name: Front-tilting bed hinge

YG066

主要材质：铁  
表面处理：白色  
Material: Iron  
Finish: White

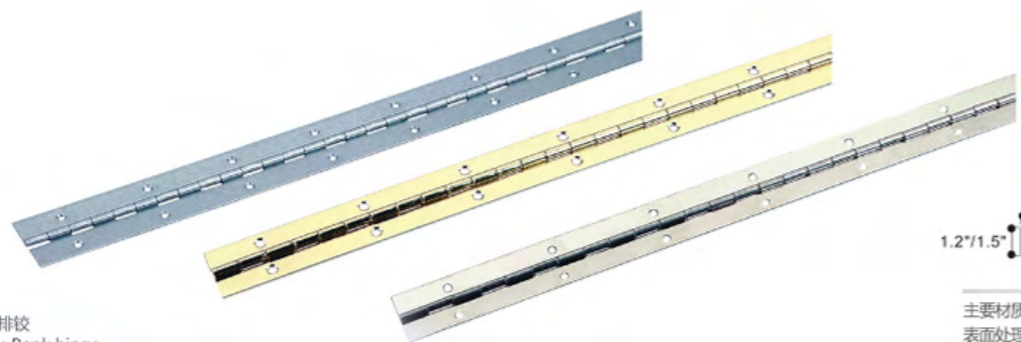

品名：排铰  
Name: Rank hinge

YG067



主要材质：不锈钢  
表面处理：金色、原色  
Material: Stainless steel  
Finish: Gold, Primary color





品名：隐藏吊码  
Name: Concealed cabinet hanger

**CG001**

主要材质：铁  
表面处理：镀锌  
Material: Iron  
Finish: Zinc

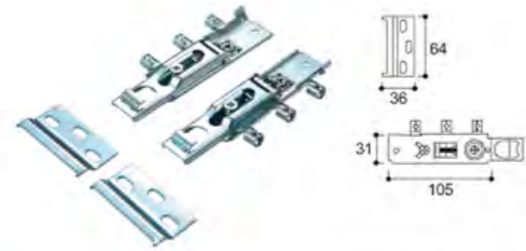

品名：隐藏吊码  
Name: Concealed cabinet hanger

**CG002**

主要材质：铁  
表面处理：镀锌  
Material: Iron  
Finish: Zinc



品名：橱柜吊码  
Name: Cabinet hanger

**CG003**

主要材质：铁  
表面处理：镀锌  
Material: Iron  
Finish: Zinc

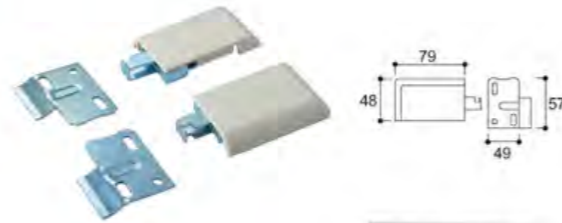

品名：橱柜吊码  
Name: Cabinet hanger

**CG004**

主要材质：ABS+铁+  
国际锌合金  
表面处理：白色、灰色  
Material: ABS+Iron  
+GB Zinc alloy  
Finish: White, gray



品名：橱柜吊码  
Name: Cabinet hanger

**CG005**

主要材质：铁  
表面处理：镀锌、喷白漆  
Material: Iron  
Finish: Zinc, White paint



品名：橱柜吊码  
Name: Cabinet hanger

**CG006**

主要材质：ABS+铁  
表面处理：白色、米黄色  
Material: ABS+Iron  
Finish: White, Ivory

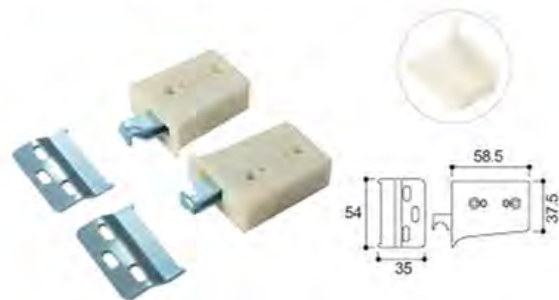

品名：橱柜吊码  
Name: Cabinet hanger

**CG007**

主要材质：ABS+铁  
表面处理：白色、米黄色  
Material: ABS+Iron  
Finish: White, Ivory



品名：橱柜吊码  
Name: Cabinet hanger

**CG008**

主要材质：ABS+铁  
表面处理：白色、米黄色  
Material: ABS+Iron  
Finish: White, Ivory



品名：缓冲器  
Name: Buffer

**CG009**

材质：塑料  
表面处理：白、灰  
Material: Plastic  
Finish: White, Grey



品名：缓冲器  
Name: Buffer

**CG010**

材质：塑料  
表面处理：白、灰  
Material: Plastic  
Finish: White, Grey



品名：缓冲器  
Name: Buffer

**CG011**

材质：塑料  
表面处理：白、灰  
Material: Plastic  
Finish: White, Grey



品名：缓冲器  
Name: Buffer

**CG012**

材质：塑料  
表面处理：白、灰  
Material: Plastic  
Finish: White, Grey



品名：反弹器(带磁)  
Name: Rebounder (with magnet)

**CG013**

材质：塑料  
表面处理：白、灰  
Material: Plastic  
Finish: White, Grey



品名：反弹器(带磁)  
Name: Rebounder (with magnet)

**CG014**

材质：塑料  
表面处理：白、灰  
Material: Plastic  
Finish: White, Grey



品名：缓冲器  
Name: Buffer

**CG015**

材质：塑料  
表面处理：白、灰  
Material: Plastic  
Finish: White, Grey



品名：反弹器(不带磁)  
Name: Rebounder (without magnet)

**CG016**

材质：塑料  
表面处理：白、灰  
Material: Plastic  
Finish: White, Grey

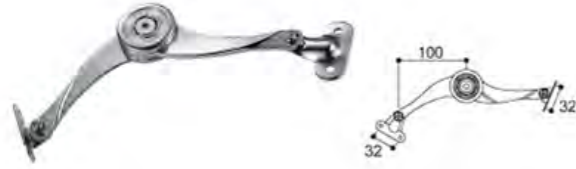

品名：任意停支撑  
Name: Lid stay

**CG017**

主要材质：国标锌合金  
表面处理：镀镍、镀铬  
Material: GB Zinc alloy  
Finish: Nickel plated, Chrome plated



品名：任意停支撑  
Name: Lid stay

**CG018**

主要材质：国标锌合金  
表面处理：镀镍、镀铬  
Material: GB Zinc alloy  
Finish: Nickel plated, Chrome plated



品名：多功能机械支撑杆  
Name: Lid stay

**CG025**

主要材质：国标锌合金+铁  
表面处理：镀镍  
Material: GB Zinc alloy+Iron  
Finish: Nickel plated



品名：多功能机械支撑杆  
Name: Lid stay

**CG026**

主要材质：国标锌合金+铁  
表面处理：镀镍  
Material: GB Zinc alloy+Iron  
Finish: Nickel plated

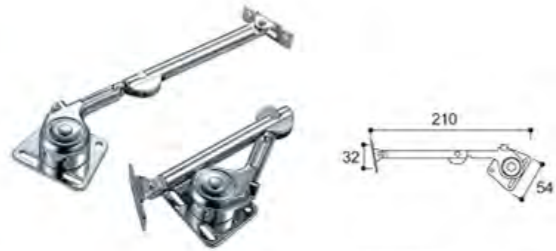

品名：液压支撑器  
Name: Hydraulic stay

**CG019**

主要材质：国标锌合金、铁  
表面处理：镀镍、镀铬  
Material: GB Zinc alloy, Iron  
Finish: Nickel plated, Chrome plated



品名：任意停支撑  
Name: Lid stay

**CG020**

主要材质：国标锌合金  
表面处理：镀镍、镀铬  
Material: GB Zinc alloy  
Finish: Nickel plated, Chrome plated



品名：多功能机械支撑杆  
Name: Lid stay

**CG027**

主要材质：ABS+铁  
表面处理：镀镍  
Material: ABS+Iron  
Finish: Nickel plated



品名：多功能机械支撑杆  
Name: Lid stay

**CG028**

主要材质：铁  
表面处理：镀镍  
Material: Iron  
Finish: Nickel plated



品名：任意停支撑  
Name: Lid stay

**CG021**

主要材质：国标锌合金  
表面处理：镀镍、镀铬  
Material: GB Zinc alloy  
Finish: Nickel plated, Chrome plated



品名：9寸折合铰  
Name: 9" folding hinge

**CG022**

主要材质：冷轧钢  
表面处理：镀镍  
Material: Cold-rolled steel  
Finish: Nickel plated



品名：4寸二折拉杆  
Name: 4" 2-fold pull rod

**CG029**

主要材质：冷轧钢  
表面处理：镀镍  
Material: Cold-rolled steel  
Finish: Nickel plated



品名：6寸二折拉杆  
Name: 6" 2-fold pull rod

**CG030**

主要材质：冷轧钢  
表面处理：镀镍  
Material: Cold-rolled steel  
Finish: Nickel plated



品名：液压支撑器  
Name: Hydraulic stay

**CG023**

主要材质：国标锌合金  
表面处理：镀镍、镀铬  
Material: GB Zinc alloy  
Finish: Nickel plated, Chrome plated



品名：超重型任意停  
Name: Ultra-heavy random stop

**CG024**

主要材质：国标锌合金  
表面处理：光面、拉丝镍  
Material: GB Zinc alloy  
Finish: Chrome, Nickel satin



品名：多功能机械支撑杆  
Name: Lid stay

**CG031**

主要材质：铁  
表面处理：镀镍  
Material: Iron  
Finish: Nickel plated



品名：多功能机械支撑杆  
Name: Lid stay

**CG032**

主要材质：铁+ABS  
表面处理：镀镍  
Material: Iron+ABS  
Finish: Nickel plated



品名: 多功能机械支撑杆  
Name: Lid stay  
**CG033**

主要材质: 铁+ABS  
表面处理: 镀镍  
Material: Iron+ABS  
Finish: Nickel plated



品名: 多功能机械支撑杆  
Name: Lid stay  
**CG034**

主要材质: 冷轧钢  
表面处理: 镀镍  
Material: Cold-rolled steel  
Finish: Nickel plated



品名: 多功能机械支撑杆  
Name: Lid stay  
**CG035**

主要材质: 铁+ABS  
表面处理: 镀镍  
Material: Iron+ABS  
Finish: Nickel plated



品名: 多功能机械支撑杆  
Name: Lid stay  
**CG036**

主要材质: 铁  
表面处理: 镀镍  
Material: Iron  
Finish: Nickel plated



品名: 气压支撑器  
Name: Gas spring  
**CG037**

主要材质: ABS+铁  
表面处理: 镀镍、镀铬  
Material: ABS+Iron  
Finish: Nickel plated, Chrome plated



品名: 气压支撑器  
Name: Gas spring  
**CG038**

主要材质: ABS+铁  
表面处理: 镀镍、镀铬  
Material: ABS+Iron  
Finish: Nickel plated, Chrome plated



品名: 气压支撑器  
Name: Gas spring  
**CG039**

主要材质: ABS+铁  
表面处理: 镀镍、镀铬  
Material: ABS+Iron  
Finish: Nickel plated, Chrome plated



品名: 气压支撑器  
Name: Gas spring  
**CG040**

主要材质: ABS+铁  
表面处理: 镀镍、镀铬  
Material: ABS+Iron  
Finish: Nickel plated, Chrome plated



Item No.:	Inside width	Resistance	Max.front weight
XY8012A	600-800mm	300N	9.0kg
XY8012B	800-1000mm	350N	11.0kg

品名: 斜上移门支撑  
Name: Flap vertical lifting  
**CG041**

主要材质: 国标锌合金  
表面处理: 沙银/镀铬  
Material: GB Zinc alloy  
Finish: Sand silver / Chrome



品名: 门铰  
Name: Door hinge  
**CG043**

材质: 铁  
表面处理: 镀镍、镀铬  
Material: Iron  
Finish: Nickel, Chrome



品名: 任意停支撑  
Name: Lid stay  
**CG042**

主要材质: 国标锌合金  
表面处理: 镀镍、镀铬  
Material: GB Zinc alloy  
Finish: Nickel plated, Chrome plated

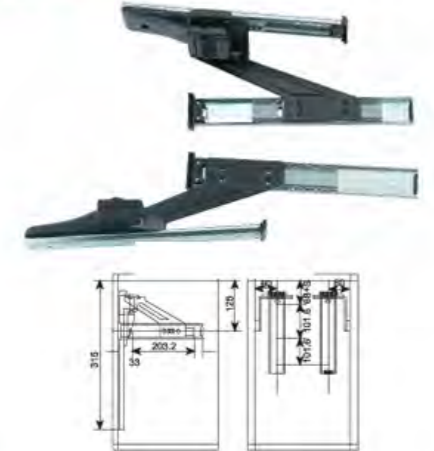

品名: 气压上移门铰 (普通型)  
Name: Pneumatic up-moving door hinge (Common-type)  
**CG044**

材质: 铁  
表面处理: 喷涂  
Material: Iron  
Finish: Spray-coated



品名: 开关门缓冲斜上移  
Name: Opening/closing buffering pneumatic flap vertical lifting  
**CG045**

材质: 铁  
表面处理: 喷涂  
Material: Iron  
Finish: Spray-coated



品名: 气动门铰  
Name: Pneumatic door hinge  
**CG046**

材质: 铁  
表面处理: 镀镍、镀铬  
Material: Iron  
Finish: Nickel, Chrome





品名：折叠上掀自动弹簧支架  
Name : Folding upwardly raises  
**CG047**

主要材质：冷轧钢  
表面处理：喷白色  
Material : Cold-rolled steel  
Finish : White paint



品名：折叠上掀支架  
Name : Folding upwardly raises  
**CG048**

主要材质：冷轧钢  
表面处理：喷白色  
Material : Cold-rolled steel  
Finish : White paint



品名：折叠上掀支架  
Name : Folding upwardly raises  
**CG049**

主要材质：冷轧钢  
表面处理：喷白色  
Material : Cold-rolled steel  
Finish : White paint



品名：折叠上掀自动弹簧支架  
Name : Folding upwardly raises  
**CG050**

主要材质：冷轧钢  
表面处理：喷白色  
Material : Cold-rolled steel  
Finish : White paint



品名：折叠上掀支架  
Name : Folding upwardly raises  
**CG051**

主要材质：冷轧钢  
表面处理：喷白色  
Material : Cold-rolled steel  
Finish : White paint



品名：折叠上掀自动弹簧支架  
Name : Folding upwardly raises  
**CG052**

主要材质：冷轧钢  
表面处理：喷白色  
Material : Cold-rolled steel  
Finish : White paint



品名：外侧双门碰  
Name : Outside double door stopper  
**CG053**

主要材质：ABS+铁  
表面处理：黑色、棕色  
Material : ABS+Iron  
Finish : Black, Brown



品名：外侧单门碰  
Name : Outside single door stopper  
**CG054**

主要材质：ABS+铁  
表面处理：黑色、棕色  
Material : ABS+Iron  
Finish : Black, Brown



品名：双门吸  
Name : Door stopper-double  
**CG055**

主要材质：塑料+铁  
表面处理：黑色、棕色  
Material : Plastic+Iron  
Finish : Black, Brown



品名：单门吸  
Name : Door stopper-single  
**CG056**

主要材质：塑料+铁  
表面处理：黑色、棕色  
Material : Plastic+Iron  
Finish : Black, Brown



品名：柜吸  
Name : Cabinet door catch  
**CG057**

主要材质：塑料+铁  
表面处理：黑色、棕色  
Material : Plastic+Iron  
Finish : Black, Brown



品名：柜吸  
Name : Cabinet door catch  
**CG058**

主要材质：塑料+铁  
表面处理：黑色、棕色  
Material : Plastic+Iron  
Finish : Black, Brown



品名：柜吸  
Name : Cabinet door catch  
**CG059**

主要材质：塑料+铁  
表面处理：白色、棕色  
Material : Plastic+Iron  
Finish : Black, Brown



品名：柜吸  
Name : Cabinet door catch  
**CG060**

主要材质：塑料+铁  
表面处理：白色、棕色  
Material : Plastic+Iron  
Finish : Black, Brown

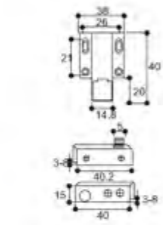

品名：单门磁碰  
Name: Single door stopper  
**CG061**

主要材质：铁+塑料  
表面处理：白色、黑色  
Material: Iron+Plastic  
Finish: White, Black

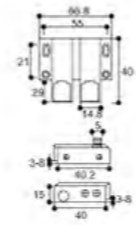

品名：双门磁碰  
Name: Double door stopper  
**CG062**

主要材质：铁+塑料  
表面处理：白色、黑色  
Material: Iron+Plastic  
Finish: White, Black

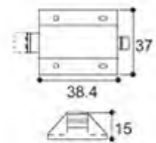

品名：单门磁碰  
Name: Single door stopper  
**CG063**

主要材质：铁+塑料  
表面处理：白色、黑色  
Material: Iron+Plastic  
Finish: White, Black

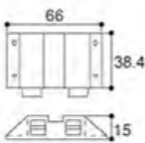

品名：双门磁碰  
Name: Double door stopper  
**CG064**

主要材质：铁+塑料  
表面处理：白色、黑色  
Material: Iron+Plastic  
Finish: White, Black

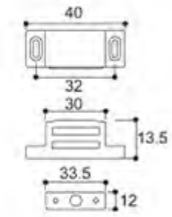

品名：柜吸  
Name: Cabinet door catch  
**CG065**

主要材质：铁  
表面处理：镀镍  
Material: Iron  
Finish: Nickel plated

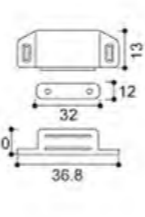

品名：柜吸  
Name: Cabinet door catch  
**CG066**

主要材质：铁  
表面处理：镀镍  
Material: Iron  
Finish: Nickel plated

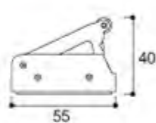

品名：反弹器  
Name: Push open system  
**CG067**

主要材质：铁  
表面处理：镀镍  
Material: Iron  
Finish: Nickel plated

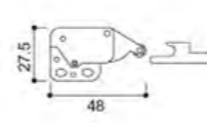

品名：反弹器  
Name: Push open system  
**CG068**

主要材质：铁+ABS  
表面处理：镀镍  
Material: Iron+ABS  
Finish: Nickel plated

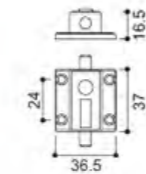

品名：弹簧插销  
Name: Spring cotter  
**CG069**

主要材质：塑料  
表面处理：黑色、棕色  
Material: Plastic  
Finish: Black, Brown

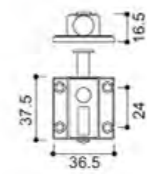

品名：弹簧插销  
Name: Spring cotter  
**CG070**

主要材质：塑料  
表面处理：黑色、棕色  
Material: Plastic  
Finish: Black, Brown

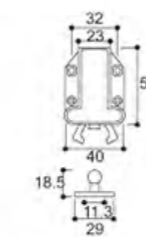

品名：甲虫器  
Name: Beetle  
**CG071**

主要材质：ABS  
表面处理：咖啡色、白色  
Material: ABS  
Finish: Coffee, White

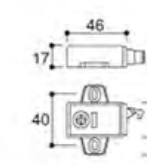

品名：塑料挂码件  
Name: Plastic piece  
**CG072**

主要材质：ABS  
表面处理：咖啡色、白色  
Material: ABS  
Finish: Coffee, White

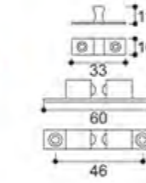

品名：磁球  
Name: Ball catch  
**CG073**

主要材质：铜  
表面处理：原色  
Material: Brass  
Finish: Primary color

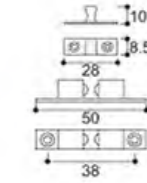

品名：磁球  
Name: Ball catch  
**CG074**

主要材质：铜  
表面处理：亮光  
Material: Copper  
Finish: Light

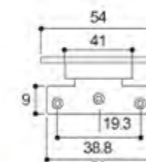

品名：合页  
Name: Hinge  
**CG075**

主要材质：ABS  
表面处理：黑色、棕色  
Material: ABS  
Finish: Black, Brown

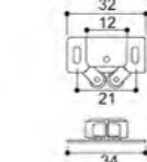

品名：磁球  
Name: Ball catch  
**CG076**

主要材质：铁  
表面处理：古铜、镀锌  
Material: Iron  
Finish: Bronze, Zinc



品名：透气孔  
Name : Ventilator

**CG077**

主要材质：不锈钢  
表面处理：拉丝  
Material : Stainless steel  
Finish : Satin



品名：透气孔  
Name : Ventilator

**CG078**

主要材质：不锈钢  
表面处理：拉丝  
Material : Stainless steel  
Finish : Satin



品名：透气孔  
Name : Ventilator

**CG079**

主要材质：不锈钢  
表面处理：白漆  
Material : Stainless steel  
Finish : White plated



品名：透气孔  
Name : Ventilator

**CG080**

主要材质：ABS  
表面处理：白色、灰色、米黄色  
Material : ABS  
Finish : White, Grey, Cream



品名：透气孔  
Name : Ventilator

**CG081**

主要材质：ABS  
表面处理：白色、灰色、米黄色  
Material : ABS  
Finish : White, Grey, Cream



品名：透气孔  
Name : Ventilator

**CG082**

主要材质：ABS  
表面处理：白色、灰色、米黄色  
Material : ABS  
Finish : White, Grey, Cream



品名：透气孔  
Name : Ventilator

**CG083**

主要材质：ABS  
表面处理：白色、灰色、米黄色  
Material : ABS  
Finish : White, Grey, Cream



品名：透气孔  
Name : Ventilator

**CG084**

主要材质：ABS  
表面处理：白色、银色、棕色、米黄色  
Material : ABS  
Finish : White, Silver, Brown, Cream



品名：透气孔  
Name : Ventilator

**CG085**

主要材质：ABS  
表面处理：白色、棕色、米黄色  
Material : ABS  
Finish : White, Brown, Cream



品名：透气孔  
Name : Ventilator

**CG086**

主要材质：ABS  
表面处理：白色、棕色、米黄色  
Material : ABS  
Finish : White, Brown, Cream



品名：透气孔  
Name : Ventilator

**CG087**

主要材质：铝  
表面处理：银色  
Material : Aluminium  
Finish : Silver

Grid Size	A	B	C	D
150	A	9	50	
200	A	9	50	
300	A	9	50	



品名：透气孔  
Name : Ventilator

**CG088**

主要材质：铝  
表面处理：银色  
Material : Aluminium  
Finish : Silver

Grid Size	A	B	C	D
150	A	15	60	
200	A	15	60	
250	A	15	60	
300	A	15	60	



品名：透气孔  
Name : Ventilator

**CG089**

主要材质：铝  
表面处理：银色  
Material : Aluminium  
Finish : Silver

Grid Size	A	B	C	D
150	A	15	80	
200	A	15	80	
225	A	15	80	
250	A	15	80	
300	A	15	80	



品名：透气孔  
Name : Ventilator

**CG090**

主要材质：塑料  
表面处理：银色  
Material : Plastic  
Finish : Silver



品名：透气孔  
Name : Ventilator

**CG091**

主要材质：ABS  
表面处理：银色  
Material : ABS  
Finish : Silver



品名：不带胶铝箔  
Name: Aluminum foil without adhesive

**CG092**

主要材质：铝  
表面处理：银色  
Material: Aluminum  
Finish: Silver



品名：带胶防水铝箔  
Name: Waterproof aluminum foil with adhesive

**CG093**

主要材质：铝  
表面处理：银色  
Material: Aluminum  
Finish: Silver



银方格



品名：地脚线  
Name: Cabinet washboard

**CG094**

主要材质：PVC  
Material: PVC  
尺寸：80/100/120/150mm  
Size: 80/100/120/150mm



品名：地脚线  
Name: Cabinet washboard

**CG095**

主要材质：铝+塑料  
表面处理：银色  
Material: Aluminum + plastics  
Finish: White



品名：U形下水道封边  
Name: U-shaped sewer edge banding

**CG096**

主要材质：ABS  
表面处理：白色  
Material: ABS  
Finish: White



品名：流水孔  
Name: Flow hole

**CG097**

主要材质：ABS  
表面处理：白色  
Material: ABS  
Finish: White



品名：下水口  
Name: Drain

**CG098**

主要材质：ABS  
表面处理：白色、棕色、灰色  
Material: ABS  
Finish: White, Brown, Grey



品名：下水口  
Name: Drain

**CG099**

主要材质：ABS  
表面处理：白色、棕色、灰色  
Material: ABS  
Finish: White, Brown, Grey



**CG100**

材质：不锈钢  
Material: Stainless steel

A	B	C	D	A	B	C	D	表面处理 Finished
100	64	32	11.5	350	224	32	11.5	拉丝(Satin)
150	96	32	11.5	400	256	32	11.5	
200	128	32	11.5	450	288	32	11.5	
250	160	32	11.5	500	320	32	11.5	
300	192	32	11.5					



**CG101**

材质：镁铝合金  
Material: Magnesium-aluminum alloy

A	B	C	D	A	B	C	D	表面处理 Finished
103	96	28	15	167	160	28	15	哑光(Dull-polished)
135	128	28	15	199	192	28	15	



**CG102**

材质：镁铝合金  
Material: Magnesium-aluminum alloy

A	B	C	D	A	B	C	D	表面处理 Finished	
100	64	30	10	250	160	30	10	哑光(Dull-polished)	
150	96	30	10	300	192	30	10		亮光(Gloss) 拉丝(Satin)
200	128	30	10						



**CG103**

材质：镁铝合金  
Material: Magnesium-aluminum alloy

A	B	C	D	A	B	C	D	表面处理 Finished	
60	32	18	13	180	160	18	13	哑光(Dull-polished)	
90	64	18	13	210	192	18	13		亮光(Gloss) 拉丝(Satin)
120	96	18	13	240	224	18	13		
150	128	18	13						



**CG104**

材质：镁铝合金  
Material: Magnesium-aluminum alloy

A	B	C	D	A	B	C	D	表面处理 Finished		
40	32	10	8.5	200	160	10	8.5	哑光(Dull-polished)		
80	64	10	8.5	240	192	10	8.5		亮光(Gloss) 拉丝(Satin)	
110	96	10	8.5	280	224	10	8.5			木纹(Wood)
150	128	10	8.5							



**CG105**

材质：镁铝合金  
Material: Magnesium-aluminum alloy

A	B	C	D	A	B	C	D	表面处理 Finished		
40	32	16	11	200	160	16	11	哑光(Dull-polished)		
80	64	16	11	240	192	16	11		亮光(Gloss) 拉丝(Satin)	
110	96	16	11	280	224	16	11			木纹(Wood)
150	128	16	11							



**CG106**

材质：锌合金+铝合金  
Material: Zinc alloy + Aluminum alloy

A	B	C	D	A	B	C	D	表面处理 Finished
77	64	16	43	141	128	16	43	哑光(Dull-polished)
109	96	16	43					



**CG107**

材质：镁铝合金  
Material: Magnesium-aluminum alloy

A	B	C	D	A	B	C	D	表面处理 Finished
46	32	18	47	110	96	18	47	哑光(Dull-polished)
78	64	18	47	142	128	18	47	

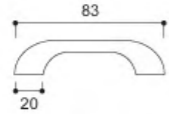

品名：拉手  
Name: Handle

**CG108**

主要材质：塑料  
表面处理：白色、黑色  
Material: Plastic  
Finish: White, Black

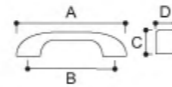

**CG109**

材质：塑料  
Material: Plastic

A	B	C	D	A	B	C	D	表面处理 Finished
	64				128			白色(White)
	96							黑色(Black) 黄色(Yellow)

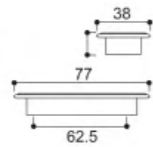

品名：拉手  
Name: Handle

**CG110**

主要材质：塑料  
表面处理：白色、黄色、黑色  
Material: Plastic  
Finish: White, Yellow, Black

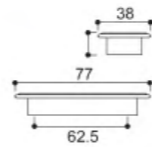

品名：拉手  
Name: Handle

**CG111**

主要材质：塑料  
表面处理：白色、黄色、黑色  
Material: Plastic  
Finish: White, Yellow, Black

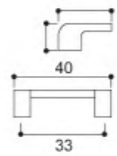

品名：拉手  
Name: Handle

**CG112**

主要材质：塑料  
表面处理：白色、黄色、黑色  
Material: Plastic  
Finish: White, Yellow, Black

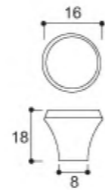

品名：拉手  
Name: Handle

**CG113**

主要材质：塑料  
表面处理：白色、黄色、黑色  
Material: Plastic  
Finish: White, Yellow, Black

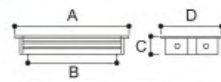

材质：锌合金+铝合金  
Material: Zinc alloy+ Aluminum alloy

**CG114**

A	B	C	D	A	B	C	D	表面处理 Finished
78	64	13	39	141	128	13	39	哑光(Dull-polished)
110	96	13	39					亮光(Gloss) 拉丝(Satin)

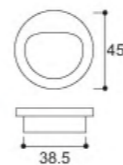

品名：拉手  
Name: Handle

**CG115**

主要材质：塑料  
表面处理：白色、黑色  
Material: Plastic  
Finish: White, Black

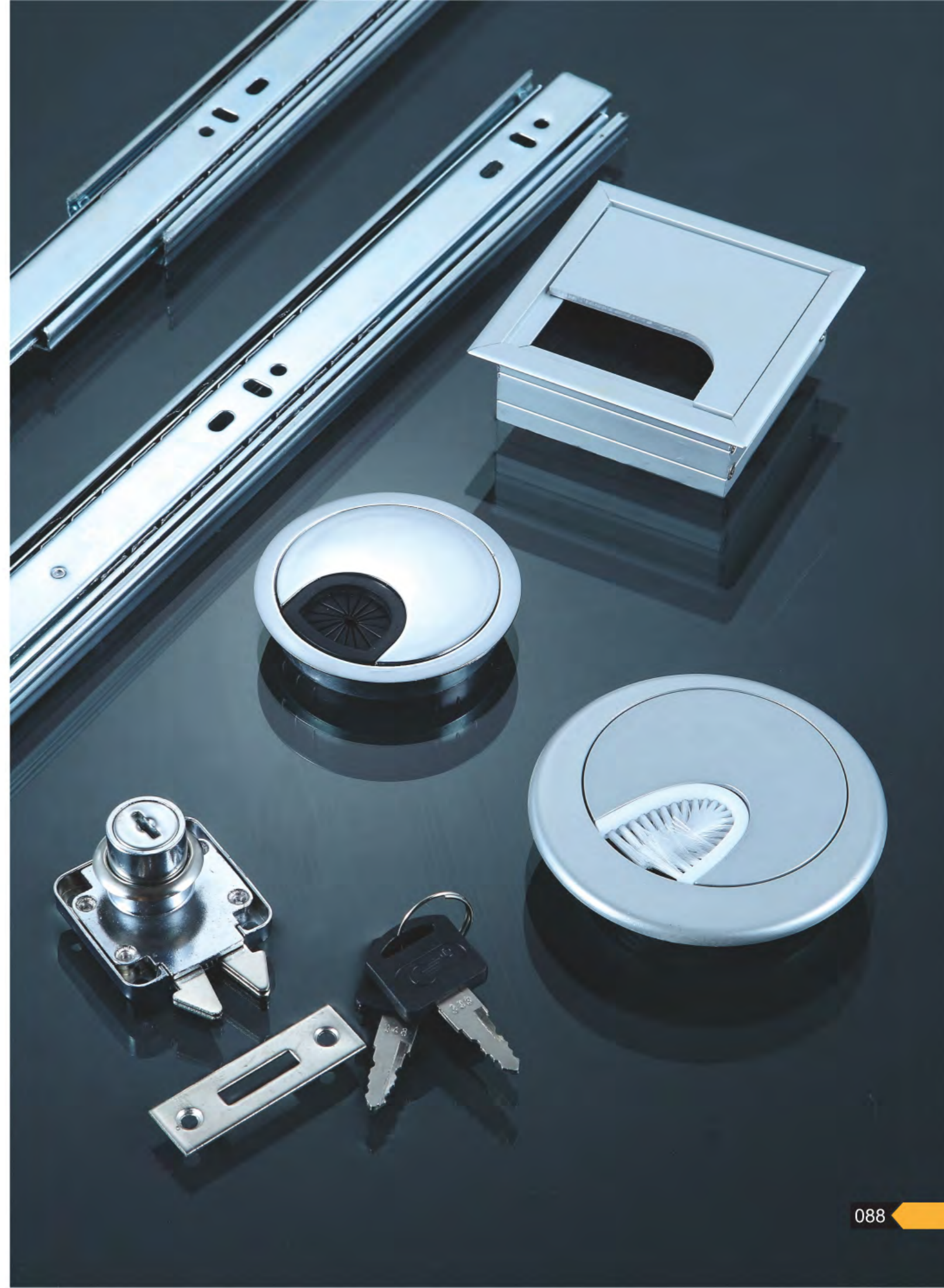



品名：正面三联锁  
Name: Front tri-lock

**S288**

材质：锌合金  
表面处理：镀铬、镀黑、镀金  
规格(Size)：D16mmxL20mm  
D19mmxL20mm  
Material: Zinc alloy  
Finish: Chrome, Black, Gold



品名：侧面三联锁  
Name: Side tri-lock

**S108**

材质：锌合金  
表面处理：镀铬、镀黑、镀金  
规格(Size)：D16mmxL20mm  
D19mmxL20mm  
Material: Zinc alloy  
Finish: Chrome, Black, Gold



品名：抽屉锁  
Name: Drawer lock

**S101**

材质：铁  
表面处理：镀铬、镀黑、镀金  
Material: Iron  
Finish: Chrome, Black, Gold



品名：自弹锁  
Name: Self-spring lock

**S338**

材质：锌合金  
表面处理：镀铬、镀黑、镀金  
规格(Size)：D19mmxL16mm  
D19mmxL20mm  
D19mmxL25mm  
D19mmxL30mm



品名：双钩锁  
Name: Double-hook lock

**S202**

材质：锌合金  
表面处理：镀铬、镀黑、镀金  
规格(Size)：D19mmxL22mm  
D19mmxL26mm  
D19mmxL32mm



品名：抽屉锁  
Name: Drawer lock

**S239**

材质：锌合金  
表面处理：镀铬、镀黑、镀金  
规格(Size)：D22mmxL22mm  
Material: Zinc alloy  
Finish: Chrome, Black, Gold  
Size: D22mmxL22mm



品名：顶锁  
Name: Top lock

**S105**

材质：锌合金  
表面处理：镀铬、镀黑、镀金  
规格(Size)：D19mmxL22mm  
Material: Zinc alloy  
Finish: Chrome, Black, Gold



品名：顶锁  
Name: Top lock

**S105B**

材质：锌合金  
表面处理：镀铬、镀黑、镀金  
规格(Size)：D19mmxL22mm  
Material: Zinc alloy  
Finish: Chrome, Black, Gold



品名：玻璃锁(双门)  
Name: Glass lock (double-door)

**S409**

材质：锌合金  
表面处理：镀铬、镀黑、镀金  
规格(Size)：D19mmxL20mm  
Material: Zinc alloy  
Finish: Chrome, Black, Gold



品名：玻璃锁(单门)  
Name: Glass lock (Single-door)

**S407**

材质：锌合金  
表面处理：镀铬、镀黑、镀金  
规格(Size)：D19mmxL20mm  
Material: Zinc alloy  
Finish: Chrome, Black, Gold



品名：玻璃锁(单门)  
Name: Glass lock (Single-door)

**S408**

材质：锌合金  
表面处理：镀铬、镀黑、镀金  
规格(Size)：D22mmxL20mm  
Material: Zinc alloy  
Finish: Chrome, Black, Gold



品名：摇摆双门柜门锁  
Name: Swing double-door cabinet door

**S238**

材质：锌合金  
表面处理：镀铬、镀黑、镀金  
Material: Zinc alloy  
Finish: Chrome, Black, Gold



品名：钩锁  
Name: Hook lock

**S103**

材质：锌合金  
表面处理：镀铬、镀黑、镀金  
Material: Zinc alloy  
Finish: Chrome, Black, Gold



品名：玻璃门滑动门锁  
Name: Glass door sliding door lock

**S235**

材质：锌合金  
表面处理：镀铬、镀黑、镀金  
Material: Zinc alloy  
Finish: Chrome, Black, Gold



品名：抽屉锁  
Name: Drawer lock

**S138A**

材质：锌合金  
表面处理：镀铬、镀黑、镀金  
规格(Size)：D19mmxL16mm  
D19mmxL20mm  
D19mmxL25mm  
D19mmxL30mm



品名：抽屉锁  
Name: Drawer lock

**S136A**

材质：锌合金、铁  
表面处理：镀铬、镀黑、镀金  
规格(Size)：D16mmxL20mm  
Material: Zinc alloy, Iron  
Finish: Chrome, Black, Gold



品名：抽屉锁  
Name: Drawer lock

**S138B**

材质：锌合金  
表面处理：镀铬、镀黑、镀金  
规格(Size)：D19mmxL16mm  
D19mmxL20mm  
D19mmxL25mm  
D19mmxL30mm



品名：天地锁  
Name: Lock

**S236**

材质：锌合金  
表面处理：镀铬、镀黑、镀金  
Material: Zinc alloy  
Finish: Chrome, Black, Gold



品名：长齿玻璃锁  
Name: Long-tooth glass lock

**S403**

材质：锌合金  
表面处理：镀铬、镀黑、镀金  
Material: Zinc alloy  
Finish: Chrome, Black, Gold



品名：长齿玻璃锁  
Name: Long-tooth glass lock

**S403B**

材质：锌合金  
表面处理：镀铬、镀黑、镀金  
Material: Zinc alloy  
Finish: Chrome, Black, Gold

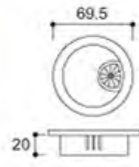

亮光

品名：穿线盒  
Name: Threading box

**BG001**

主要材质：塑料  
Material: Plastic



金色



沙银



黑色

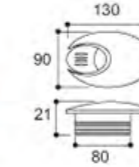

品名：舌形线盒  
Name: Ligulate wire box

**BG007**

主要材质：国际锌合金  
表面处理：光铬、拉丝镍、珍珠铬、红古铜  
Material: GB Zinc alloy  
Finish: Chrome, Satin nickel, Pearl chrome, Red bronze

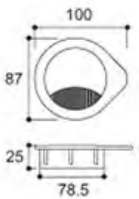

品名：80带毛线盒  
Name: 80 Zonal seta wire box

**BG008**

主要材质：ABS  
表面处理：银灰色、黑色  
Material: ABS  
Finish: Silver gray, Black

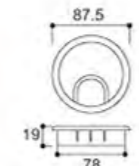

亮光

品名：穿线盒  
Name: Threading box

**BG002**

主要材质：国际锌合金  
Material: GB Zinc alloy



沙银



拉丝



古铜

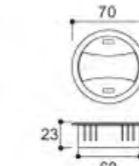

品名：线盒  
Name: Wire box

**BG009**

主要材质：ABS  
表面处理：灰色、黑色  
Material: ABS  
Finish: Gray, Black

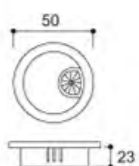

品名：线盒  
Name: Wire box

**BG010**

主要材质：ABS  
表面处理：灰色、黑色  
Material: ABS  
Finish: Gray, Black

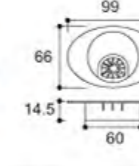

品名：线盒(胶条、毛条)  
Name: Wire box(Rubber strip/Fur strip)

**BG003**

主要材质：国际锌合金  
表面处理：光铬、拉丝镍、珍珠铬、红古铜  
Material: GB Zinc alloy  
Finish: Chrome, Satin nickel, Pearl chrome, Red bronze

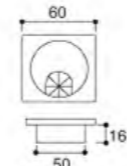

品名：穿线盒  
Name: Threading box

**BG004**

主要材质：ABS  
表面处理：银灰色、黑色  
Material: ABS  
Finish: Silver gray, Black

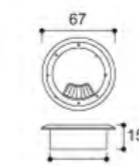

品名：塑料带点线盒  
Name: Plastic junction box with dots

**BG011**

主要材质：ABS  
表面处理：灰色、黑色  
Material: ABS  
Finish: Gray, Black

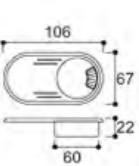

品名：4线线盒  
Name: 4-line junction box

**BG012**

主要材质：ABS  
表面处理：灰色、黑色  
Material: ABS  
Finish: Gray, Black

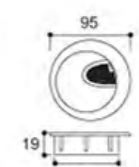

品名：80带毛线盒  
Name: 80 Zonal seta wire box

**BG005**

主要材质：ABS  
表面处理：银灰色、黑色  
Material: ABS  
Finish: Silver gray, Black

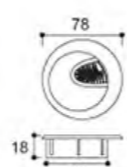

品名：60带毛线盒  
Name: 60 Zonal seta wire box

**BG006**

主要材质：ABS  
表面处理：银灰色、黑色  
Material: ABS  
Finish: Silver gray, Black

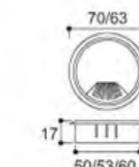

品名：塑料圆形线盒  
Name: Plastic roundness wire box

**BG013**

主要材质：ABS  
表面处理：灰色、黑色  
Material: ABS  
Finish: Gray, Black

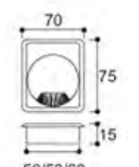

品名：塑料方形线盒  
Name: Plastic square wire box

**BG014**

主要材质：ABS  
表面处理：灰色、黑色  
Material: ABS  
Finish: Gray, Black



品名：35线盒  
Name : 35 Wire box  
**BG015**

主要材质：ABS  
表面处理：灰色、黑色  
Material : ABS  
Finish : Gray, Black



品名：35线盒  
Name : 35 Wire box  
**BG016**

主要材质：国标锌合金  
表面处理：光铬、拉丝镍、珍珠铬、红古铜  
Material : GB Zinc alloy  
Finish : Chrome, Satin nickel, Pearl chrome, Red bronze



品名：25线盒孔  
Name : 25 Junction box hole  
**BG017**

主要材质：锌合金  
表面处理：光铬  
Material : Zinc alloy  
Finish : Chrome



品名：无底线盒  
Name : Bottomless line box  
**BG018**

主要材质：ABS  
表面处理：灰色、黑色  
Material : ABS  
Finish : Gray, Black



品名：铝材线盒  
Name : Aluminum wire box  
**BG019**

主要材质：铝合金  
表面处理：银灰色、黑色  
Material : Aluminium alloy  
Finish : Silver gray, Black



品名：电脑穿线条  
Name : Computer line strip  
**BG020**

主要材质：ABS  
表面处理：沙银、白色、黑色  
Material : ABS  
Finish : Sand silver, White, Black



品名：鞋架  
Name : Shoes racks  
**BG021**

主要材质：铁  
表面处理：白色、黑色  
Material : Iron  
Finish : White, Black



品名：鞋架  
Name : Shoes racks  
**BG022**

主要材质：铁  
表面处理：白色、黑色  
Material : Iron  
Finish : White, Black



品名：鞋架  
Name : Shoes racks  
**BG023**

主要材质：ABS  
表面处理：黄色  
Material : ABS  
Finish : Yellow



品名：鞋架  
Name : Shoes racks  
**BG024**

主要材质：ABS  
表面处理：白色、黑色  
Material : ABS  
Finish : White, Black



品名：鞋柜架  
Name : Shoes rack  
**BG025**

主要材质：ABS  
表面处理：黑色  
Material : ABS  
Finish : Grey



品名：鞋柜架  
Name : Shoes rack  
**BG026**

主要材质：ABS  
表面处理：黑色  
Material : ABS  
Finish : Grey



品名：键盘架  
Name : Keyboard rack  
**BG027**

主要材质：ABS  
表面处理：白色、黑色  
Material : ABS  
Finish : White, Black



品名：键盘架  
Name : Keyboard rack  
**BG028**

主要材质：ABS  
表面处理：白色、黑色  
Material : ABS  
Finish : White, Black



品名：电脑主机架  
Name : Computer head unit rack  
**BG029**

主要材质：塑料  
表面处理：白色、黑色  
Material : Plastic  
Finish : White, Black



品名：电脑主机架  
Name : Computer head unit rack  
**BG030**

主要材质：塑料  
表面处理：白色、黑色  
Material : Plastic  
Finish : White, Black



主要材质：铁  
表面处理：镀锌、彩锌、黑锌  
规格(Size)：12寸-18寸  
Material：Iron  
Finish: Blue zinc-plated, Color zinc-plated,  
Black zinc-plated



品名：2710二节轨  
Name：Two-section track

**BG031**

主要材质：铁  
表面处理：镀锌、彩锌、黑锌  
规格(Size)：10寸-20寸  
Material：Iron  
Finish: Blue zinc-plated, Color zinc-plated,  
Black zinc-plated



品名：3510三节轨  
Name：Three-section track

**BG032**

主要材质：铁  
表面处理：镀锌、彩锌、黑锌  
规格(Size)：10寸-20寸  
Material：Iron  
Finish: Blue zinc-plated, Color zinc-plated,  
Black zinc-plated



品名：4510三节轨  
Name：Three-section track

**BG033**

主要材质：铁  
表面处理：镀锌、彩锌、黑锌  
规格(Size)：10寸-20寸  
Material：Iron  
Finish: Blue zinc-plated, Color zinc-plated,  
Black zinc-plated



品名：4510三折式缓冲道轨  
Name：3-section buffering track

**BG034**

主要材质：铁  
表面处理：镀锌、彩锌、黑锌  
规格(Size)：12寸-22寸  
Material：Iron  
Finish: Blue zinc-plated, Color zinc-plated,  
Black zinc-plated



品名：4510自弹三折轨  
Name：3-section track

**BG035**

主要材质：冷轧钢板  
表面处理：镀锌  
规格(Size)：宽=35  
Material：Cold-rolled steel  
Finish：Zinc-plated



品名：2710键盘轨  
Name：Keyboard rail

**BG036**

主要材质：冷轧钢板  
表面处理：镀锌  
规格(Size)：宽=35  
Material：Cold-rolled steel  
Finish：Zinc-plated



品名：3510键盘轨  
Name：Keyboard rail

**BG037**

主要材质：铁  
表面处理：镀锌  
规格(Size)：10寸-22寸  
Material：Iron  
Finish：Zinc-plated



品名：隐藏式二节道轨-自滑  
Name：Concealed 2-section  
guide rail-buffer

**BG038**

主要材质：铁  
表面处理：镀锌  
规格(Size)：10寸-22寸  
Material：Iron  
Finish：Zinc-plated



品名：隐藏式二节道轨-缓冲  
Name：Concealed 2-section guide  
rail-buffer

**BG039**

主要材质：铁  
表面处理：镀锌  
规格(Size)：10寸-22寸  
Material：Iron  
Finish：Zinc-plated



品名：隐藏式二节道轨-弹压  
Name：Concealed 2-section  
guide rail-spring

**BG040**

表面处理: 电镀, 蓝锌, 电泳黑, 黑锌, 五彩  
长度: 150-406mm  
高度: 17±0.1mm  
组装高度: 9.8±0.2mm  
承重: 每一套承10kg  
安装方式: 侧面安装  
使用范围: 木制抽屉



品名: 二节走珠滑轨  
Name: 2-section ball rail

**BG041**

材料: 冷轧钢板  
规格: 285mm-490mm  
表面处理: 镀蓝锌, 彩锌, 黑锌  
Size: 285mm-490mm  
Material: Cold-rolled steel  
Finish: Blue zinc-plated, Color zinc-plated, Black zinc-plated



品名: 2710二节钢轨(托底)  
Name: 2-section steel rail (bottoming)

**BG042**

安装示意图  
Installation illustrator

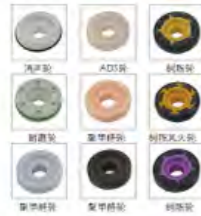

材质: 铁 Material: Iron  
表面处理: 镀铬 Finish: Chr  
厚度: 1.2mm Thickness: 1.2mm



品名: 托底道轨  
Description: Sound semml-automawer draawer slide

**BG043**



**BG044**

品名: 抽屉侧板轨  
Description: Metal box draawer slide



**BG045**

材质: 铁 Material: Iron  
表面处理: 镀铬 Finish: Chrome plated  
厚度: 1.0mm Thickness: 1.0mm

**产品描述**

- 开启角度: 100°
  - 铰杯高度: 11.3毫米
  - 铰杯直径: 35毫米
  - 面板尺寸(K): 3-7毫米
  - 铰杯两孔距离: 48毫米
  - 门可选用板厚度: 1.4-20毫米
  - 铰杯类型
- Open degree: 100°
  - Height of hinge cup: 11.3mm
  - Diameter of hinge cup: 35mm
  - Distance from edge of door to the cup (K): 3-7mm
  - Distance of two hole center: 48mm
  - Recommended door thickness: 1.4-20mm
  - Hinge cup types

杯厚度可选范围

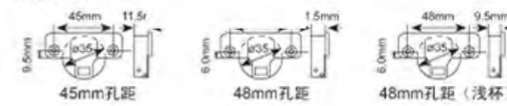

材料: 冷轧钢板  
表面处理: 镀铬  
Material: Cold-rolled steel  
Finish: Nickel



直臂 Full Overlay

**BG046**

D: 叠位计算值表 Overlay calculations

D	3	4	5	6	7	
H	0	16	17	18	19	20
	2	14	15	16	17	18



直臂 Full Overlay

**BG049**

D: 叠位计算值表 Overlay calculations

D	3	4	5	6	7	
H	0	16	17	18	19	20
	2	14	15	16	17	18



中曲 Half Overlay

**BG047**

D: 叠位计算值表 Overlay calculations

D	3	4	5	6	7	
H	0	7	8	9	10	11
	2	5	6	7	8	9



中曲 Half Overlay

**BG050**

D: 叠位计算值表 Overlay calculations

D	3	4	5	6	7	
H	0	7	8	9	10	11
	2	5	6	7	8	9



大曲 Inserted

**BG048**

D: 叠位计算值表 Overlay calculations

D	3	4	5	6	7	
H	2	-2.5	-1.5	-0.5	0.5	1.5



大曲 Inserted

**BG051**

D: 叠位计算值表 Overlay calculations

D	3	4	5	6	7	
H	2	-2.5	-1.5	-0.5	0.5	1.5

产品描述

- 开启角度:165度
  - 铰杯高度:11.3毫米
  - 铰杯直径:35毫米
  - 面板尺寸(K):3-7毫米
  - 铰杯两孔距离:48毫米
  - 门可选用板厚度:14-20毫米
  - 铰杯类型:铁/锌合金
- Open degree:165°
  - Height of hinge cup:11.3mm
  - Diameter of hinge cup:35mm
  - Distance from edge of door to the cup (K):3-7mm
  - Distance of two hole center:48mm
  - Recommended door thickness:14-20mm
  - Hinge cup types: Iron/zinc alloy

杯厚度可选范围

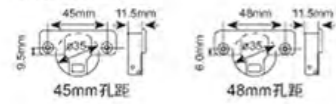

主要材质:冷轧钢板  
表面处理:镍镀  
Material: Cold-rolled steel  
Finish: Nickel

产品描述

- 开启角度:105度
- 适用铝框宽度:19-23毫米
- 铰杯类型
- Opening angle:105°
- Alumium framee thickness:19-23mm
- Hinge cup types

杯厚度可选范围

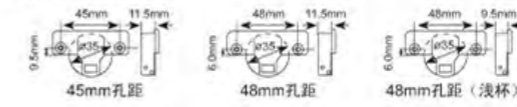

产品描述

- 开启角度:95度
- 铰杯直径:26mm
- 门板C距离:4-6毫米
- 适用玻璃厚度:4-6毫米
- Opening angle:95°
- Diameter of hinge cup:26mm
- Door(C)dimension:4-6mm
- Glass thickness:4-6mm

装饰盖 Decorative Cover



直臂 Full Overlay

**BG052**

D: 高位计算值表 Overlay calculations

D	3	4	5	6	7	
H	0	16	17	18	19	20
	2	14	15	16	17	18

直臂 Full Overlay

**BG055**

D: 高位计算值表 Overlay calculations

D	3	4	5	6	7	
H	0	16	17	18	19	20

直臂 Full Overlay

**BG058**

D: 高位计算值表 Overlay calculations

D	3	4	5	6	7	
H	0	18	19	20	21	22
	2	16	17	18	19	20

直臂 Full Overlay

**BG061**

D: 高位计算值表 Overlay calculations

D	3	4	5	6	7	
H	0	18	19	20	21	22
	2	18	17	18	19	20
	4	14	15	16	17	18

中曲 Half Overlay

**BG053**

D: 高位计算值表 Overlay calculations

D	3	4	5	6	7	
H	0	7	8	9	10	11
	2	5	6	7	8	9

中曲 Half Overlay

**BG056**

D: 高位计算值表 Overlay calculations

D	3	4	5	6	7	
H	0	7	8	9	10	11

中曲 Half Overlay

**BG059**

D: 高位计算值表 Overlay calculations

D	3	4	5	6	7	
H	0	8	9	10	11	12

中曲 Half Overlay

**BG062**

D: 高位计算值表 Overlay calculations

D	3	4	5	6	7	
H	0	9	10	11	12	13
	2	7	8	9	10	11
	4	5	6	7	8	9

大曲 Inserted

**BG054**

D: 高位计算值表 Overlay calculations

D	3	4	5	6	7	
H	0	1	0	-1	-2	-3
	2	-2.5	-1.5	-0.5	0.5	1.5

大曲 Inserted

**BG057**

D: 高位计算值表 Overlay calculations

D	3	4	5	6	7	
H	2	-2.5	-1.5	-0.5	0.5	1.5

大曲 Inserted

**BG060**

D: 高位计算值表 Overlay calculations

D	3	4	5	6	7	
H	0	0	1	2	3	4
	2	-2	-3	0	1	2

大曲 Inserted

**BG063**

D: 高位计算值表 Overlay calculations

D	3	4	5	6	7	
H	0	0	-1	-2	-3	-4
	2	1	0	-1	-2	
	4	3	2	1	0	



品名：脚钉  
Name: Nails

**DG001**

主要材质：塑料+铁  
表面处理：白色、黑色、棕色  
Material: Plastic+Iron  
Finish: White, Black, Brown



品名：脚钉  
Name: Nails

**DG002**

主要材质：塑料+铁  
表面处理：白色、黑色、棕色  
Material: Plastic+Iron  
Finish: White, Black, Brown



品名：防滑脚钉  
Name: Anti-skidding nails

**DG003**

主要材质：塑料+铁  
表面处理：白色、黑色、棕色  
Material: Plastic+Iron  
Finish: White, Black, Brown



品名：脚钉  
Name: Nails

**DG004**

主要材质：塑料+铁  
表面处理：白色、黑色、棕色  
Material: Plastic+Iron  
Finish: White, Black, Brown



品名：脚钉  
Name: Nails

**DG005**

主要材质：塑料+铁  
表面处理：白色、黑色、棕色  
Material: Plastic+Iron  
Finish: White, Black, Brown



品名：脚钉  
Name: Nails

**DG006**

主要材质：塑料+铁  
表面处理：白色、黑色、棕色  
Material: Plastic+Iron  
Finish: White, Black, Brown



品名：脚钉  
Name: Nails

**DG007**

主要材质：塑料+铁  
表面处理：白色、黑色、棕色  
Material: Plastic+Iron  
Finish: White, Black, Brown



品名：脚钉  
Name: Nails

**DG008**

主要材质：塑料+铁  
表面处理：白色、黑色、棕色  
Material: Plastic+Iron  
Finish: White, Black, Brown



品名：脚钉  
Name: Nails

**DG009**

主要材质：塑料+铁  
表面处理：白色、黑色、棕色  
Material: Plastic+Iron  
Finish: White, Black, Brown



品名：脚钉  
Name: Nails

**DG010**

主要材质：塑料+铁  
表面处理：白色、黑色、棕色  
Material: Plastic+Iron  
Finish: White, Black, Brown



品名：脚钉(带毛)  
Name: Nails(zonal seta)

**DG017**

主要材质：塑料+铁  
表面处理：白色、黑色、棕色  
Material: Plastic+Iron  
Finish: White, Black, Brown



品名：脚钉(带毛)  
Name: Nails(zonal seta)

**DG018**

主要材质：塑料+铁  
表面处理：白色、黑色、棕色  
Material: Plastic+Iron  
Finish: White, Black, Brown



品名：脚钉  
Name: Nails

**DG011**

主要材质：塑料+铁  
表面处理：白色、黑色、棕色  
Material: Plastic+Iron  
Finish: White, Black, Brown



品名：脚钉  
Name: Nails

**DG012**

主要材质：塑料+铁  
表面处理：白色、黑色、棕色  
Material: Plastic+Iron  
Finish: White, Black, Brown



品名：脚钉  
Name: Nails

**DG019**

主要材质：塑料+铁  
表面处理：白色、黑色、棕色  
Material: Plastic+Iron  
Finish: White, Black, Brown



品名：脚钉  
Name: Nails

**DG020**

主要材质：塑料+铁  
表面处理：白色、黑色、棕色  
Material: Plastic+Iron  
Finish: White, Black, Brown

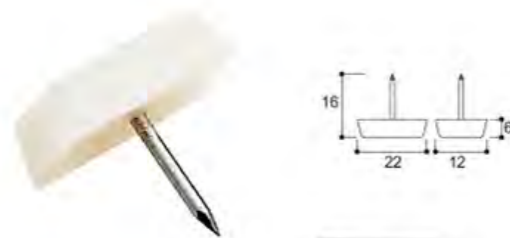

品名：单边脚钉  
Name: Unilateral nails

**DG013**

主要材质：塑料+铁  
表面处理：白色、黑色、透明  
Material: Plastic+Iron  
Finish: White, Black, Transparent

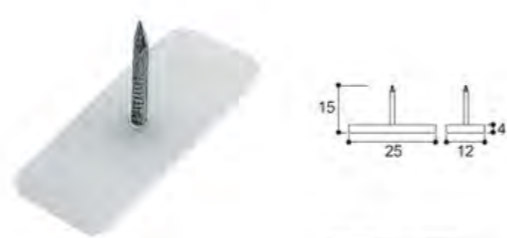

品名：单边脚钉  
Name: Unilateral nails

**DG014**

主要材质：塑料+铁  
表面处理：白色、黑色、透明  
Material: Plastic+Iron  
Finish: White, Black, Transparent



品名：防滑脚钉  
Name: Anti-skidding nails

**DG021**

主要材质：塑料+铁  
表面处理：白色、黑色、透明  
Material: Plastic+Iron  
Finish: White, Black, Transparent



品名：脚钉  
Name: Furniture glide

**DG022**

主要材质：塑料+铁  
表面处理：黑色  
Material: Plastic+Iron  
Finish: Black



品名：脚钉(带毛)  
Name: Nails(zonal seta)

**DG015**

主要材质：塑料+铁  
表面处理：白色、黑色、棕色  
Material: Plastic+Iron  
Finish: White, Black, Brown



品名：脚钉(带毛)  
Name: Nails(zonal seta)

**DG016**

主要材质：塑料+铁  
表面处理：白色、黑色、棕色  
Material: Plastic+Iron  
Finish: White, Black, Brown



品名：脚钉  
Name: Nails

**DG023**

主要材质：塑料+铁  
表面处理：白色、黑色、棕色  
Material: Plastic+Iron  
Finish: White, Black, Brown



品名：双边脚钉  
Name: Bilateral nails

**DG024**

主要材质：塑料+铁  
表面处理：白色、黑色、透明  
Material: Plastic+Iron  
Finish: White, Black, Transparent

品名：长脚垫  
Name : New long pad

**DG025**

主要材质：尼龙  
表面处理：白色、棕色、黑色、灰色  
Material : Plastic  
Finish : White, Brown Black, Grey

品名：长脚垫  
Name : New long pad

**DG026**

主要材质：尼龙  
表面处理：白色、棕色、黑色、灰色  
Material : Plastic  
Finish : White, Brown Black, Grey

品名：长脚垫  
Name : New long pad

**DG027**

主要材质：尼龙  
表面处理：白色、棕色、黑色  
Material : Plastic  
Finish : White, Brown Black

品名：长脚垫  
Name : New long pad

**DG028**

主要材质：尼龙  
表面处理：白色、棕色、黑色、灰色  
Material : Plastic  
Finish : White, Brown Black, Grey

品名：长脚垫  
Name : New long pad

**DG029**

主要材质：尼龙  
表面处理：白色、棕色、黑色、灰色  
Material : Plastic  
Finish : White, Brown Black, Grey

品名：长脚垫  
Name : New long pad

**DG030**

主要材质：尼龙  
表面处理：白色、棕色、黑色、灰色  
Material : Plastic  
Finish : White, Brown Black, Grey

品名：鸭嘴可调脚垫  
Name : Adjustable foot pad

**DG031**

主要材质：塑料  
表面处理：灰色、黑色、黄色  
Material : Plastic  
Finish : Grey, Black, Yellow

品名：鸭嘴可调脚垫  
Name : Adjustable foot pad

**DG032**

主要材质：塑料  
表面处理：白色、黑色、黄色  
Material : Plastic  
Finish : White, Black, Yellow

品名：可调脚垫  
Name : Adjustable foot pad

**DG033**

主要材质：塑料  
表面处理：灰色、黑色、棕色  
Material : Plastic  
Finish : Grey, Black, Brown

品名：可调脚垫  
Name : Adjustable foot pad

**DG034**

主要材质：塑料  
表面处理：灰色、黑色、棕色  
Material : Plastic  
Finish : Grey, Black, Brown

品名：活动可调脚  
Name : Removable type adjustable leg

**DG035**

主要材质：锌合金+塑料  
表面处理：光铬  
Material : Zinc alloy+Plastic  
Finish : Pearl chrome

品名：活动可调脚  
Name : Removable type adjustable leg

**DG036**

主要材质：锌合金+塑料  
表面处理：光铬  
Material : Zinc alloy+Plastic  
Finish : Pearl chrome

品名：固定可调脚  
Name : Stationary type adjustable leg

**DG037**

主要材质：国标锌合金+塑料  
表面处理：光铬  
Material : GB Zinc alloy+Iron+Plastic  
Finish : Pearl chrome

品名：活动可调脚  
Name : Removable type adjustable leg

**DG038**

主要材质：铁+塑料  
表面处理：光铬  
Material : Iron+Plastic  
Finish : Pearl chrome

品名：活动可调脚  
Name : Removable type adjustable leg

**DG039**

主要材质：国标锌合金+塑料  
表面处理：光铬  
Material : GB Zinc alloy+Iron+Plastic  
Finish : Pearl chrome

品名：活动可调脚  
Name : Removable type adjustable leg

**DG040**

主要材质：铁+塑料  
表面处理：光铬  
Material : Iron+Plastic  
Finish : Pearl chrome

品名：活动可调脚  
Name : Removable type adjustable leg

**DG041**

主要材质：铁+塑料  
表面处理：光铬  
Material : Iron+Plastic  
Finish : Pearl chrome

品名：固定可调脚  
Name : Stationary type adjustable leg

**DG042**

主要材质：铁+塑料  
表面处理：光铬  
Material : Iron+Plastic  
Finish : Pearl chrome

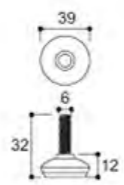

品名：活动可调脚  
Name: Exercise adjustable leg  
**DG043**

主要材质：铁+塑料  
表面处理：光铬  
Material: Iron+Plastic  
Finish: Pearl chrome

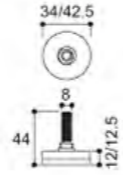

品名：可调脚  
Name: Adjustable leg  
**DG044**

主要材质：国标锌合金+铁+塑料  
表面处理：银色+白色  
Material: GB Zinc alloy+Iron+Plastic  
Finish: Silver+White

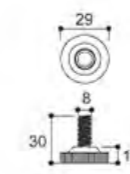

品名：可调脚  
Name: Adjustable leg  
**DG053**

主要材质：塑料+铁  
表面处理：白色  
Material: Plastic+Iron  
Finish: White

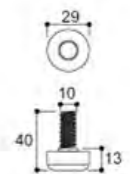

品名：可调脚  
Name: Adjustable leg  
**DG054**

主要材质：塑料+铁  
表面处理：白色+黑色  
Material: Plastic+Iron  
Finish: White+Black

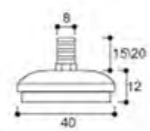

品名：活动可调脚  
Name: Removable type adjustable leg  
**DG045**

主要材质：锌合金+塑料  
表面处理：光铬  
Material: Zinc alloy+Plastic  
Finish: Pearl chrome

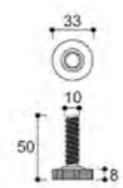

品名：可调脚  
Name: Adjustable leg  
**DG046**

主要材质：塑料+铁  
表面处理：黑色  
Material: Plastic+Iron  
Finish: Black

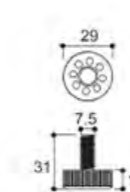

品名：可调脚  
Name: Adjustable leg  
**DG055**

主要材质：塑料+铁  
表面处理：白色  
Material: Plastic+Iron  
Finish: White

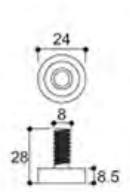

品名：可调脚  
Name: Adjustable leg  
**DG056**

主要材质：塑料+铁  
表面处理：白色  
Material: Plastic+Iron  
Finish: White

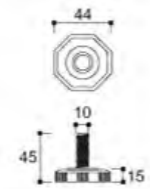

品名：可调脚  
Name: Adjustable leg  
**DG047**

主要材质：塑料+铁  
表面处理：黑色  
Material: Plastic+Iron  
Finish: Black

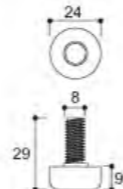

品名：可调脚  
Name: Adjustable leg  
**DG048**

主要材质：塑料+铁  
表面处理：黑色  
Material: Plastic+Iron  
Finish: Black

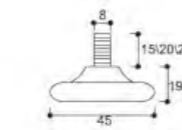

品名：活动可调脚  
Name: Removable type adjustable leg  
**DG057**

主要材质：塑料+铁  
表面处理：黑色  
Material: Plastic+Iron  
Finish: Black

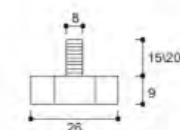

品名：活动可调脚  
Name: Removable type adjustable leg  
**DG058**

主要材质：塑料+铁  
表面处理：黑色  
Material: Plastic+Iron  
Finish: Black

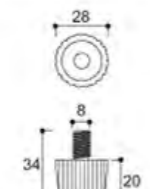

品名：可调脚  
Name: Adjustable leg  
**DG049**

主要材质：塑料+铁  
表面处理：黑色  
Material: Plastic+Iron  
Finish: Black

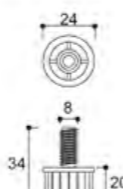

品名：可调脚  
Name: Adjustable leg  
**DG050**

主要材质：塑料+铁  
表面处理：黑色  
Material: Plastic+Iron  
Finish: Black

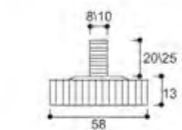

品名：活动可调脚  
Name: Removable type adjustable leg  
**DG059**

主要材质：塑料+铁  
表面处理：黑色  
Material: Plastic+Iron  
Finish: Black

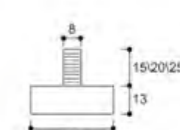

品名：活动可调脚  
Name: Removable type adjustable leg  
**DG060**

主要材质：塑料+铁  
表面处理：黑色+白色  
Material: Plastic+Iron  
Finish: Black+white

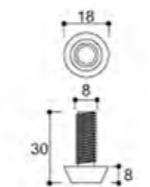

品名：可调脚  
Name: Adjustable leg  
**DG051**

主要材质：塑料+铁  
表面处理：黑色  
Material: Plastic+Iron  
Finish: Black

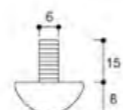

品名：活动可调脚  
Name: Removable type adjustable leg  
**DG052**

主要材质：塑料+铁  
表面处理：黑色  
Material: Plastic+Iron  
Finish: Black

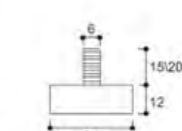

品名：活动可调脚  
Name: Removable type adjustable leg  
**DG061**

主要材质：塑料+铁  
表面处理：黑色  
Material: Plastic+Iron  
Finish: Black

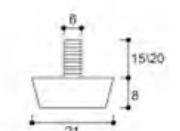

品名：活动可调脚  
Name: Removable type adjustable leg  
**DG062**

主要材质：塑料+铁  
表面处理：黑色  
Material: Plastic+Iron  
Finish: Black



主要材质: 尼龙+铁  
表面处理: 白色、黑色、灰色、蓝色  
Material: Nylon+Iron  
Finish: White / Black / Grey / Blue

DG063

规格 Size					
1.25"	30mm	33mm	35mm	35mm	35mm
1.5"	40mm	38mm	38mm	57mm	57mm
2"	50mm	45.5mm	47mm	66mm	66mm



主要材质: 尼龙+铁  
表面处理: 白色、黑色、灰色、蓝色  
Material: Nylon+Iron  
Finish: White / Black / Grey / Blue

DG064

规格 Size					
1.25"	30mm	33mm	35mm	35mm	35mm
1.5"	40mm	38mm	38mm	57mm	57mm
2"	50mm	45.5mm	47mm	66mm	66mm



主要材质: 尼龙+铁  
表面处理: 白色、黑色、灰色、蓝色  
Material: Nylon+Iron  
Finish: White / Black / Grey / Blue

DG069

规格 Size				
1.5"	40mm	38mm	38mm	57mm
2"	50mm	45.5mm	47mm	66mm



主要材质: 锌合金+尼龙+铁  
表面处理: 光铬+黑色  
Material: Zinc alloy+Nylon+Iron  
Finish: Chrome+Black

DG070

规格 Size				
1.5"	40mm	38mm	38mm	57mm
2"	50mm	45.5mm	47mm	66mm



主要材质: 尼龙+铁  
表面处理: 白色、黑色、灰色、蓝色  
Material: Nylon+Iron  
Finish: White / Black / Grey / Blue

DG065

规格 Size					
1.25"	30mm	33mm	35mm	35mm	35mm
1.5"	40mm	38mm	38mm	57mm	57mm
2"	50mm	45.5mm	47mm	66mm	66mm



主要材质: 尼龙+铁  
表面处理: 白色、黑色、灰色、蓝色  
Material: Nylon+Iron  
Finish: White / Black / Grey / Blue

DG066

规格 Size					
1.25"	30mm	33mm	35mm	35mm	35mm
1.5"	40mm	38mm	38mm	57mm	57mm
2"	50mm	45.5mm	47mm	66mm	66mm



主要材质: 锌合金+尼龙+铁  
表面处理: 光铬+黑色  
Material: Zinc alloy+Nylon+Iron  
Finish: Chrome+Black

DG071

规格 Size				
1.5"	40mm	38mm	38mm	57mm
2"	50mm	45.5mm	47mm	66mm

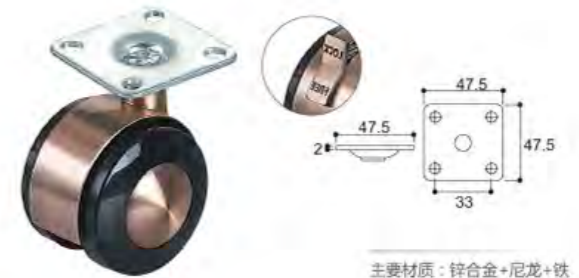

主要材质: 锌合金+尼龙+铁  
表面处理: 光铬+古铜  
Material: Zinc alloy+Nylon+Iron  
Finish: Chrome+Brass

DG072

规格 Size				
1.5"	40mm	38mm	38mm	57mm
2"	50mm	45.5mm	47mm	66mm

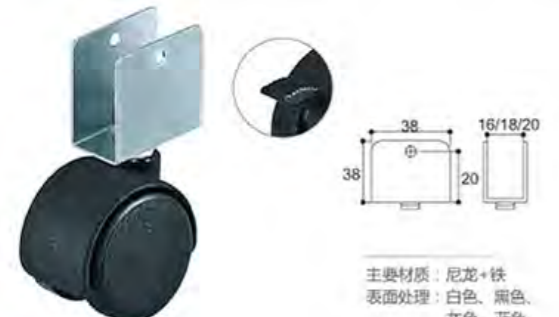

主要材质: 尼龙+铁  
表面处理: 白色、黑色、灰色、蓝色  
Material: Nylon+Iron  
Finish: White / Black / Grey / Blue

DG067

规格 Size					
1.25"	30mm	33mm	35mm	35mm	35mm
1.5"	40mm	38mm	38mm	57mm	57mm
2"	50mm	45.5mm	47mm	66mm	66mm



主要材质: 尼龙+铁  
表面处理: 白色、黑色、灰色、蓝色  
Material: Nylon+Iron  
Finish: White / Black / Grey / Blue

DG068

规格 Size					
1.25"	30mm	33mm	35mm	35mm	35mm
1.5"	40mm	38mm	38mm	57mm	57mm
2"	50mm	45.5mm	47mm	66mm	66mm



主要材质: 尼龙+铁  
表面处理: 白色、黑色、灰色、蓝色  
Material: Nylon+Iron  
Finish: White / Black / Grey / Blue

DG073

规格 Size				
2.5"	60mm	44mm	50mm	82mm



主要材质: 尼龙+铁  
表面处理: 白色、黑色、灰色、蓝色  
Material: Nylon+Iron  
Finish: White / Black / Grey / Blue

DG074

规格 Size				
2.5"	60mm	44mm	50mm	82mm



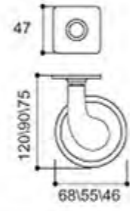

主要材质: 尼龙+锌合金+铁  
表面处理: 白色、灰色、黄色、红色、蓝色  
Material: Nylon+Zinc alloy+Iron  
Finish: White, Grey, Yellow, Red, Blue

品名: 万向轮(有刹/无刹)  
Name: Universal wheel  
**DG075**



品名: 床轮  
Name: Bed wheel  
**DG076**

主要材质: ABS+铁  
表面处理: 白色  
Material: ABS+Iron  
Finish: White



品名: 工业轮(有刹/无刹)  
Name: Industrial caster (With Brake/without brake)  
**DG077**

主要材质: 尼龙+铁  
表面处理: 白色  
Material: Nylon+Iron  
Finish: White



品名: 工业轮  
Name: Industrial caster  
**DG078**

主要材质: 尼龙+铁  
表面处理: 白色、黑色、灰色、蓝色  
Material: Nylon+Iron  
Finish: White, Black, Grey, Blue

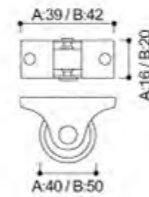

品名: 工业轮(有刹/无刹)  
Name: Industrial caster (With Brake/without brake)  
**DG079**

主要材质: 尼龙+铁  
表面处理: 白色  
Material: Nylon+Iron  
Finish: White

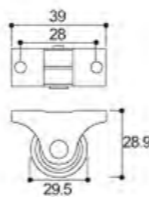
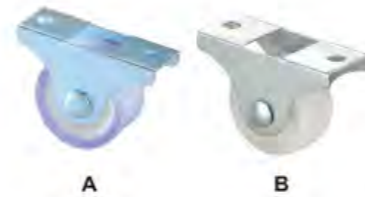

品名: 工业轮  
Name: Industrial caster  
**DG080**

主要材质: 尼龙+铁  
表面处理: 白色  
Material: Nylon+Iron  
Finish: White



主要材质: 塑料  
表面处理: 光银、银灰色  
Material: Plastic  
Finish: Polishing silver, Silver gray

品名: 床包角  
Name: Bed angle  
**DG081**



主要材质: 国标锌合金  
表面处理: 光银、银灰色  
Material: GB Zinc alloy  
Finish: Polishing silver, Silver gray

品名: 床包角  
Name: Bed angle  
**DG082**

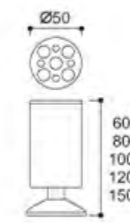

品名: 柜脚  
Name: Cabinet leg  
**DG083**

主要材质: 铝合金  
表面处理: 光格、沙银、喷沙  
Material: Aluminum  
Finish: Chrome/Matt Nickel/Sand-sprayed

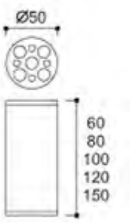

品名: 柜脚  
Name: Cabinet leg  
**DG084**

主要材质: 铝合金  
表面处理: 光格、沙银、喷沙  
Material: Aluminum  
Finish: Chrome/Matt Nickel/Sand-sprayed

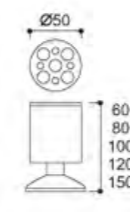

品名: 柜脚  
Name: Cabinet leg  
**DG085**

主要材质: 铝合金  
表面处理: 沙银  
Material: Aluminum  
Finish: Sand Spray

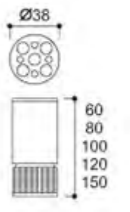

品名: 柜脚  
Name: Cabinet leg  
**DG086**

主要材质: 铝合金  
表面处理: 沙银  
Material: Aluminum  
Finish: Sand Spray

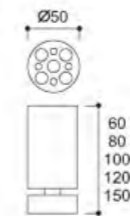

品名: 柜脚  
Name: Cabinet leg  
**DG087**

主要材质: 塑料  
表面处理: 沙银  
Material: Plastic  
Finish: Sand Spray

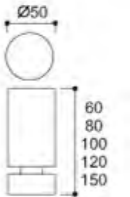

品名: 柜脚  
Name: Cabinet leg  
**DG088**

主要材质: 锌合金  
表面处理: 光格、沙银、喷沙  
Material: Zinc alloy  
Finish: Chrome/Matt Nickel/Sand-sprayed

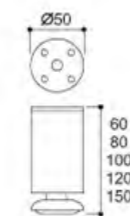

品名: 柜脚  
Name: Cabinet leg  
**DG089**

主要材质: 铝合金  
表面处理: 沙银  
Material: Aluminum  
Finish: Sand Spray

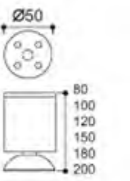

品名: 柜脚  
Name: Cabinet leg  
**DG090**

主要材质: 铝合金  
表面处理: 青古铜、红古铜、亮光  
Materials: Aluminum alloy  
Finish: Bronze, Red bronze, Bright

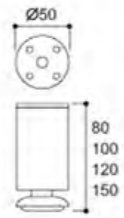

主要材质: 铝合金  
表面处理: 沙金、沙黑、沙银  
Materials: Aluminum alloy  
Finish: Glod dust, Satin black, Satin silver

品名: 柜脚  
Name: Cabinet leg  
**DG091**

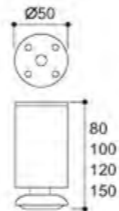

主要材质: 铝合金  
表面处理: 沙金、沙黑、沙银  
Materials: Aluminum alloy  
Finish: Glod dust, Satin black, Satin silver

品名: 柜脚  
Name: Cabinet leg  
**DG092**

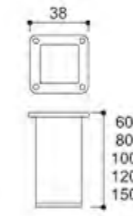

主要材质: 铝合金  
表面处理: 沙银  
Material: Aluminum  
Finsh: Sand Spray

品名: 柜脚  
Name: Cabinet leg  
**DG099**

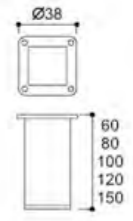

主要材质: 铝合金  
表面处理: 沙银  
Material: Aluminum  
Finsh: Sand Spray

品名: 柜脚  
Name: Cabinet leg  
**DG100**

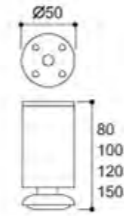

主要材质: 铝合金  
表面处理: 沙金、沙黑、沙银  
Materials: Aluminum alloy  
Finish: Glod dust, Satin black, Satin silver

品名: 柜脚  
Name: Cabinet leg  
**DG093**

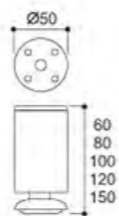

主要材质: 锌合金  
表面处理: 红古铜  
Material: Zinc alloy  
Finsh: Antique copper

品名: 柜脚  
Name: Cabinet leg  
**DG094**

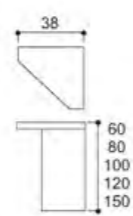

主要材质: 铝合金  
表面处理: 沙银  
Material: Aluminum  
Finsh: Sand Spray

品名: 柜脚  
Name: Cabinet leg  
**DG101**

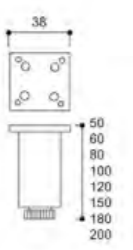

主要材质: 铝合金  
表面处理: 沙银  
Material: Aluminum  
Finsh: Sand Spray

品名: 柜脚  
Name: Cabinet leg  
**DG102**

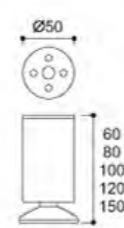

主要材质: 不锈钢  
表面处理: 钢拉丝  
Material: Stainless steel  
Finsh: Steel drawbench

品名: 柜脚  
Name: Cabinet leg  
**DG095**

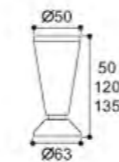

主要材质: 铝合金  
表面处理: 青古铜、红古铜、亮光  
Material: Aluminum alloy  
Finsh: Bronze, Red bronze, Bright

品名: 柜脚  
Name: Cabinet leg  
**DG096**

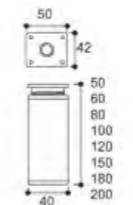

主要材质: 铝合金+塑料  
表面处理: 沙银  
Material: Aluminum+Plactic  
Finsh: Sand Spray

品名: 柜脚  
Name: Cabinet leg  
**DG103**

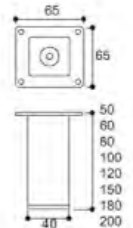

主要材质: 不锈钢  
表面处理: 钢拉丝  
Material: Stainless steel  
Finsh: Steel drawbench

品名: 柜脚  
Name: Cabinet leg  
**DG104**

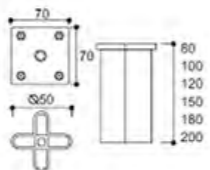

主要材质: 铝合金  
表面处理: 沙银  
Material: Aluminum  
Finsh: Sand Spray

品名: 柜脚  
Name: Cabinet leg  
**DG097**

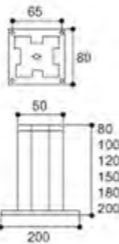

主要材质: 铝合金  
表面处理: 沙银  
Material: Aluminum  
Finsh: Sand Spray

品名: 柜脚  
Name: Cabinet leg  
**DG098**

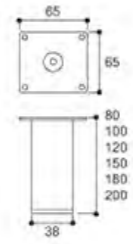

主要材质: 不锈钢  
表面处理: 钢拉丝  
Material: Stainless steel  
Finsh: Steel drawbench

品名: 柜脚  
Name: Cabinet leg  
**DG105**

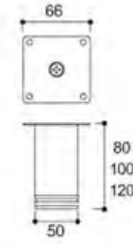

主要材质: 不锈钢+铁+ABS  
表面处理: 抛光  
Material: Stainless steel+Iron+ABS  
Finsh: Polish

品名: 柜脚  
Name: Cabinet leg  
**DG106**

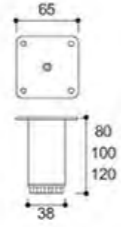

品名：柜脚  
Name: Cabinet leg  
**DG107**

主要材质：不锈钢+铁+ABS  
表面处理：拉丝镍  
Material: Stainless steel+ Iron+ABS  
Finish: Nickel satin

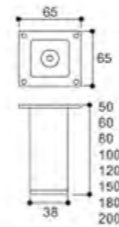

品名：柜脚  
Name: Cabinet leg  
**DG108**

主要材质：不锈钢+塑料  
表面处理：亮光  
Material: Stainless steel+ Plastic  
Finish: Bright

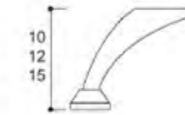

品名：柜脚  
Name: Cabinet leg  
**DG115**

主要材质：铁  
表面处理：光铬  
Material: Iron  
Finish: Chrome

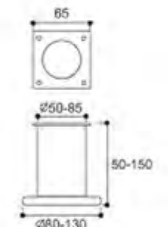

品名：柜脚  
Name: Cabinet leg  
**DG116**

主要材质：铁  
表面处理：光铬  
Material: Iron  
Finish: Chrome

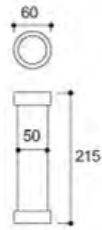

品名：直吧台脚  
Name: Straight bar counter leg  
**DG109**

主要材质：国标锌合金  
表面处理：光铬  
Material: GB Zinc alloy  
Finish: Chrome

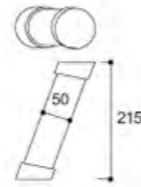

品名：斜吧台脚  
Name: Tilted bar counter leg  
**DG110**

主要材质：国标锌合金  
表面处理：光铬  
Material: GB Zinc alloy  
Finish: Chrome

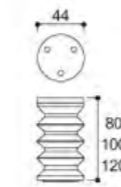

品名：柜脚  
Name: Cabinet leg  
**DG117**

主要材质：铝  
表面处理：氧化  
Material: GB Zinc alloy  
Finish: Oxidation

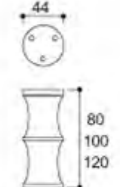

品名：柜脚  
Name: Cabinet leg  
**DG118**

主要材质：铝  
表面处理：氧化  
Material: GB Zinc alloy  
Finish: Oxidation

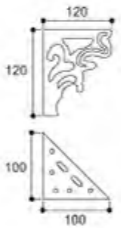

品名：柜脚  
Name: Cabinet leg  
**DG111**

主要材质：铁  
表面处理：光铬  
Material: Iron  
Finish: Chrome

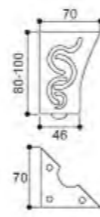

品名：柜脚  
Name: Cabinet leg  
**DG112**

主要材质：铁  
表面处理：光铬  
Material: Iron  
Finish: Chrome



品名：柜脚  
Name: Cabinet leg  
**DG119**

主要材质：铝  
表面处理：氧化  
Material: GB Zinc alloy  
Finish: Oxidation

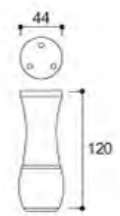

品名：柜脚  
Name: Cabinet leg  
**DG120**

主要材质：铝  
表面处理：氧化  
Material: GB Zinc alloy  
Finish: Oxidation

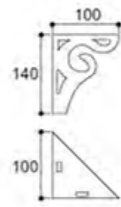

品名：柜脚  
Name: Cabinet leg  
**DG113**

主要材质：铁  
表面处理：光铬  
Material: Iron  
Finish: Chrome

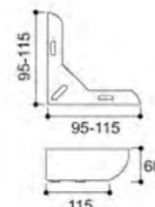

品名：柜脚  
Name: Cabinet leg  
**DG114**

主要材质：铁  
表面处理：光铬  
Material: Iron  
Finish: Chrome

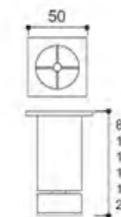

品名：柜脚  
Name: Cabinet leg  
**DG121**

主要材质：塑料  
表面处理：光铬、沙镍、喷沙  
Material: Plastic  
Finish: Chrome, Matt Nickel, Sand-sprayed

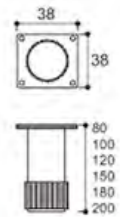

品名：柜脚  
Name: Cabinet leg  
**DG122**

主要材质：塑料  
表面处理：光铬、沙镍、喷沙  
Material: Plastic  
Finish: Chrome, Matt Nickel, Sand-sprayed

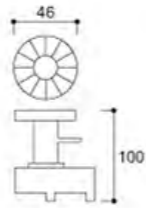

品名: 橱柜脚  
Name: Cupboard leg  
**DG123**

材质: 塑料  
表面处理: 白色  
Material: Plastic  
Finish: White

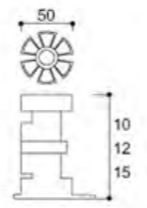

品名: 橱柜脚  
Name: Cupboard leg  
**DG124**

材质: 塑料  
表面处理: 黑色  
Material: Plastic  
Finish: Black

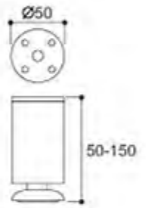

品名: 柜脚  
Name: Cabinet leg  
**DG125**

主要材质: 铝合金  
表面处理: 蓝线、白线、黑线  
Materials: Aluminum alloy  
Finish: Blue line, White line, black line

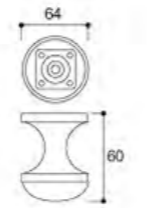

品名: 橱柜脚  
Name: Cupboard leg  
**DG126**

主要材质: ABS+铁  
表面处理: 白色  
Material: ABS+Iron  
Finish: White

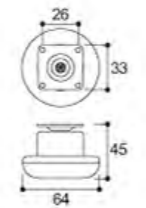

品名: 橱柜脚  
Name: Cupboard leg  
**DG127**

主要材质: 塑料+铁  
表面处理: 白色、黑色、灰色、蓝色  
Material: Plastic+Iron  
Finish: White, Black, Grey, Blue

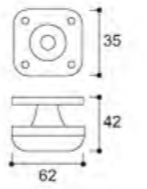

品名: 橱柜脚  
Name: Cupboard leg  
**DG128**

材质: 塑料  
表面处理: 黑色  
Material: Plastic  
Finish: Yellow, Black

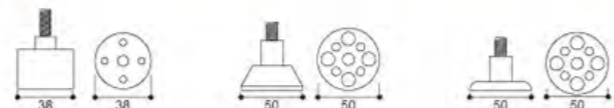

品名: 柜脚配件  
Name: Cabinet leg accessories  
**DG129**



**DG130**  
品名: 办公台脚  
材质: 不锈钢、铁  
表面处理: 拉丝、喷沙、亮光  
Name: Office desk leg  
Material: Stainless steel, Iron  
Finish: Drawbench, Sand-sprayed, Mirror polished



**DG131**  
品名: 办公台脚  
材质: 不锈钢、铁  
表面处理: 拉丝、喷沙、亮光  
Name: Office desk leg  
Material: Stainless steel, Iron  
Finish: Drawbench, Sand-sprayed, Mirror polished



**DG132**  
品名: 办公台脚  
材质: 不锈钢、铁  
表面处理: 拉丝、喷沙、亮光  
Name: Office desk leg  
Material: Stainless steel, Iron  
Finish: Drawbench, Sand-sprayed, Mirror polished



**DG133**  
品名: 办公台脚  
材质: 不锈钢、铁  
表面处理: 拉丝、喷沙、亮光  
Name: Office desk leg  
Material: Stainless steel, Iron  
Finish: Drawbench, Sand-sprayed, Mirror polished



**DG134**  
品名: 办公台脚  
材质: 不锈钢、铁  
表面处理: 拉丝、喷沙、亮光  
Name: Office desk leg  
Material: Stainless steel, Iron  
Finish: Drawbench, Sand-sprayed, Mirror polished



**DG135**  
品名: 办公台脚  
材质: 不锈钢、铁  
表面处理: 拉丝、喷沙、亮光  
Name: Office desk leg  
Material: Stainless steel, Iron  
Finish: Drawbench, Sand-sprayed, Mirror polished



**DG136**  
品名: 办公台脚  
材质: 不锈钢、铁  
表面处理: 拉丝、喷沙、亮光  
Name: Office desk leg  
Material: Stainless steel, Iron  
Finish: Drawbench, Sand-sprayed, Mirror polished



**DG137**  
品名: 办公台脚  
材质: 不锈钢、铁  
表面处理: 拉丝、喷沙、亮光  
Name: Office desk leg  
Material: Stainless steel, Iron  
Finish: Drawbench, Sand-sprayed, Mirror polished