



RONGXIANG

Chengdu Rongxiang Technology Co.,Ltd



PROFESSIONAL



QUALITY



WIN-WIN



Table of Contents

	Speed Hump -----	03		Cable Protector -----	08
	Kerb Hose Ramp -----	11		Threshold Ramp -----	12
	Wheel Stops Chock -----	13		Corner Guard -----	15
	Traffic Cone -----	16		Cone Topper -----	21
	Traffic Cone Bar -----	22		Traffic Sign -----	23
	Warning Light -----	24		Lane Separator -----	29
	Road Barrier -----	31		Barrier -----	32
	Plastic Safety Crash Bucket -----	33		Post/Bollard -----	35
	Barrier -----	40		Road stub -----	43
	Radar Traffic Limit Sign -----	45		Convex/Spherical/Concave Mirror -----	46
	Inspection Mirror -----	47		Safety Vest -----	48
	Warning Tape -----	49		Warning Signage -----	50
	Umbrella Cone -----	51		Floor Sign -----	52
	Wheel Measurer -----	53		Warning Triangle -----	54
	Traffic Baton -----	55		Wheel Clamp -----	56
	Bicycle Rack -----	57		Folding Rack -----	58

Speed Hump Series

- The rubber speed hump is installed with a light reflection that can attract driver's attention even in the evening.
- Can lower vehicle's speed when cars pass.
- Easy to install with nails.
- Made of high quality rubber, tough, durable.



Model	Number	Middle Section		End Cap	
		Size	Weight	Size	Weight
RX-JSD-10R-13D	(1)	1000*350*50mm/pc	14kg/pc	175*350*50mm/pc	1.8kg/pc
RX-JSD-10R-16B	(2)	1000*380*50mm/pc	15kg/pc	190*380*50mm/pc	2kg/pc
RX-JSD-5R-05	(3)	500*300*45mm/pc	6kg/pc	250*300*45mm/pc	2kg/pc
RX-JSD-5R-12H	(4)	500*350*50mm/pc	9kg/pc	250*350*50mm/pc	1.8kg/pc
RX-JSD-5R-11B	(5)	500*350*50mm/pc	7kg/pc	175*350*50mm/pc	1.8kg/pc
RX-JSD-5R-12F	(6)	500*350*50mm/pc	7kg/pc	175*350*50mm/pc	2kg/pc
RX-JSD-5R-15	(7)	500*400*40mm/pc	7.5kg/pc	200*400*40mm/pc	1.9kg/pc
RX-JSD-5R-23	(8)	500*500*55mm/pc	14kg/pc	270*500*55mm/pc	4kg/pc
RX-JSD-2R-06B	(9)	250*350*50mm/pc	3.75kg/pc	175*350*50mm/pc	1.8kg/pc
RX-JSD-6R-03	(10)	600*500*32mm/pc	9kg/pc	600*250*32mm/pc	3kg/pc
RX-JSD-9R-01	(11)	900*500*50mm/pc	19kg/pc	900*250*50mm/pc	7.5kg/pc
RX-OZDB-18	(12)	3000*1800*65mm/pc	300kg/pc		

New Speed Hump



Model	Number	Material	Middle Size	End Cap/Corner	Packing
RX-JSD-18R-02	①	Rubber	1830*300*58mm 21kg/pc	150*300*58mm 2.2kg/pc	woven bag
RX-JSD-18R-01D	②	Rubber	1830*300*50mm 22kg/pc	190*300*50mm	woven bag
RX-JSD-12R-03	③	Rubber	1200*300*50mm 12.5kg/pc	190*300*50mm	woven bag
RX-JSD-9R-01C	④	Rubber	900*300*50mm 12kg/pc	120*300*50mm	woven bag

Arrow Speed Hump

Be designed for heavy traffic roads.



Model	Middle Size	End Size	Reflective Stripe	Middle Weight	End Weight	Packing
RX-JSD-5R-30A	500*1000*75mm	250*1000*75mm	1PC*200mm width	23kg	9kg	woven bag
RX-JSD-5R-30B	500*550*75mm	250*550*75mm	1PC*200mm width	14kg	4kg	woven bag
RX-JSD-5R-30C	500*400*50mm	250*400*50mm	2PC*200mm width	7kg	3kg	woven bag
RX-JSD-5R-30D	500*400*75mm	250*400*75mm	2PC*200mm width	13.5kg	6kg	woven bag



Plastic Speed Hump

This plastic speed hump is High-tech products, made of high strength plastic, and can stand the pressure of more than 50 tons, no fading within three years.

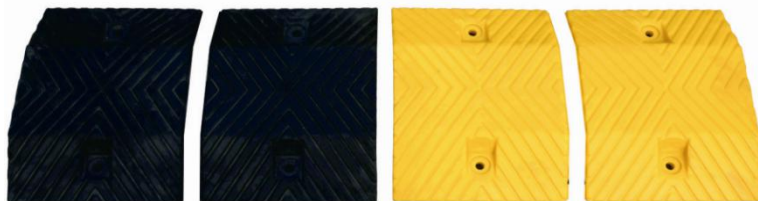

①



②

Model	Number	Middle Section		End Cap	
		Size	Weight	Size	Weight
RX-JSD-2P-04	①	250*345*50mm/pc	5.4kg/pc	Φ 350mm	0.5kg
RX-JSD-5P-09A	②	500*350*40mm/pc	4.5kg/pc	Φ 350mm	0.5kg
RX-JSD-5P-07C	③	500*320*40mm/pc	2.5kg/pc	Φ 320mm	0.25kg



③

More details

LENGTH	Material
250/320/400/500/600/800/900/1000/1220/1830mm	Rubber/plastic



Please call us for more details.

Portable Speed Hump

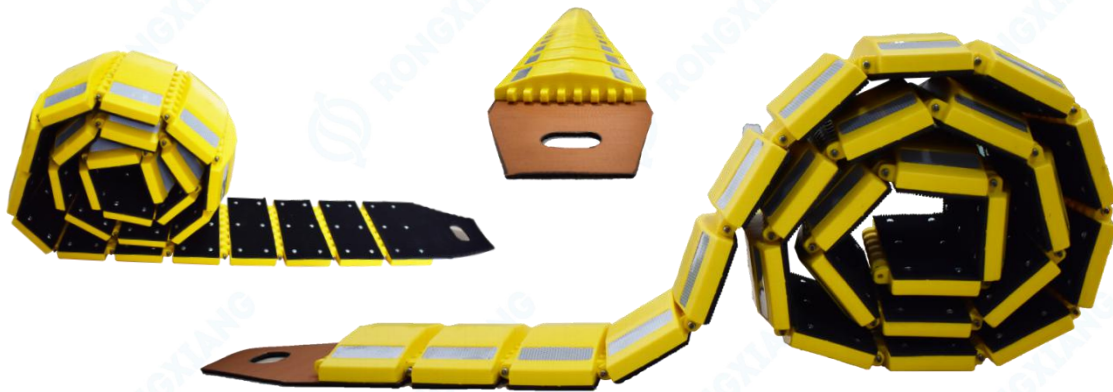

Model		RX-BJSD-04
Middle Section	Size	3000*230*40mm
	Weight	13kg/pc

- This speed hump is made of high quality PVC and PP.
- Be portable, movable.
- Easy to install.
- High stability.
- Cost effective.
- High bearing capacity

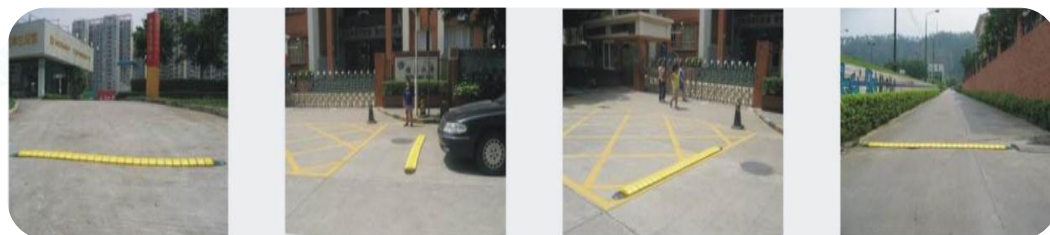

Model	Material	Size	Fold Length	Weight	Bear Capacity	Packing
RX-BJSD-06	TPU	3000*250*25mm	310mm	12kg	20tons	360*250*310mm

Rubber Pedestrian Crossing

- Be made of vulcanized rubber, is durable and adapted to the environment.
- Consist of movable modular parts.
- Easy to install and remove.
- With reflective part, be light in night.
- Anti-slip surface.



Model	Length	Width	Height	Parts
RX-RXD-03	6000mm	3000mm	75mm	24×Black Middle 24×White Middle 20×End Caps 4×Corner Piece
	7000mm	4000mm	75mm	42×Black Middle 42×White Middle 24×End Caps 4×Corner Piece

Black Middle



500*500*75mm 17kg/pc

White/Yellow Middle



500*500*75mm 19kg/pc

Side Cap



500*500*75mm 12kg/pc

Corner



500*500*75mm 11kg/pc

Cable Protector

Cord cover used in protecting all kinds of power cords, lines and cables from damage, and keep floors clear. They can be joined together to meet your different requirement in length. And can bear the heavy weight without broken.

Easy to install and remove.

Brilliant color for safety warnings.

With heavy duty Dog-Bone connector interlocks modular sections to join them together.



Model	Material	Length	Width	Height	Channel	Color
RX-XC-10R-02	PVC	1000mm	133mm	20mm	39x13mm 1.2kg/pc	Yellow
RX-XC-10R-04	Rubber	1000mm	215mm	38mm	80x25mm 4.2kg/pc	Black
RX-XC-10R-03A	Rubber	1000mm	140mm	20mm	39x13mm 1.5kg/pc	Black



Model	Material	Length	Width	Height	Channel	Color
RX-XC-90R-01	PVC	9000mm	64mm	11mm	16x6.4mm 4.2kg/pc	Black
RX-XC-90R-02	PVC	9000mm	76mm	16mm	19x9.5mm 7kg/pc	Black
RX-XC-90R-03	PVC	9000mm	76mm	2.5mm	38x16mm 10kg/pc	Black

AMS Cable Protector System

The AMS cable protector system is made of PVC, used for large-scale events. To protect cable and road safety.

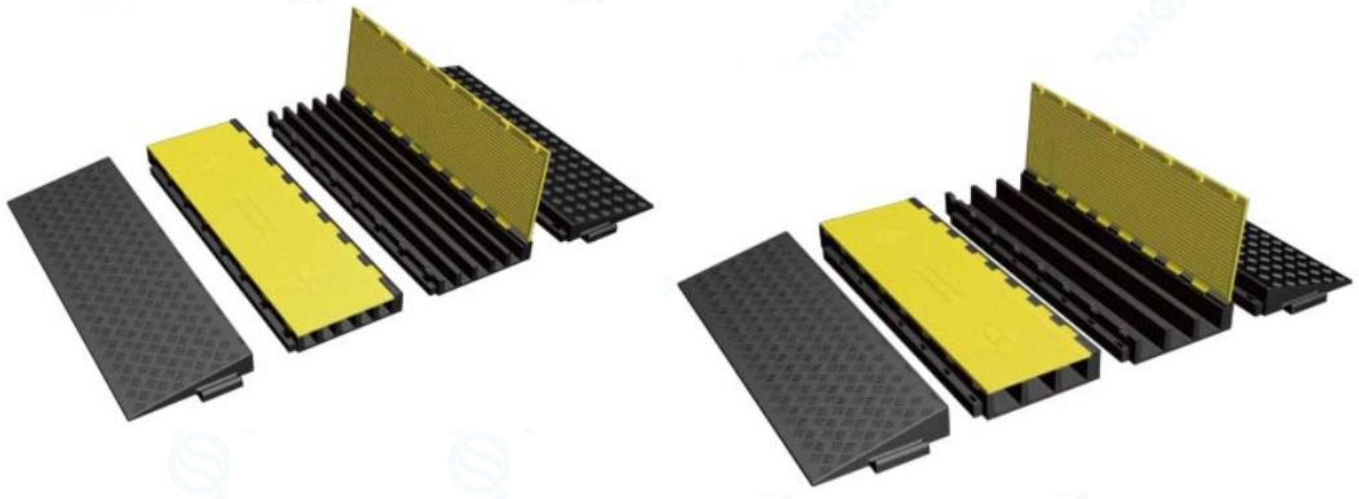

Model	Middle Size	Side Size	Channel	Channel Size	Middle Weight	Side Weight	Bearing Capacity
RX-5XC-9R-01	950*300*55mm	950*300*55mm	5 channel	40*40mm	6.5kg	9kg	20tons
RX-3XC-9R-01	950*300*55mm	950*300*75mm	3channel	65*65mm	7.5kg	11kg	20tons



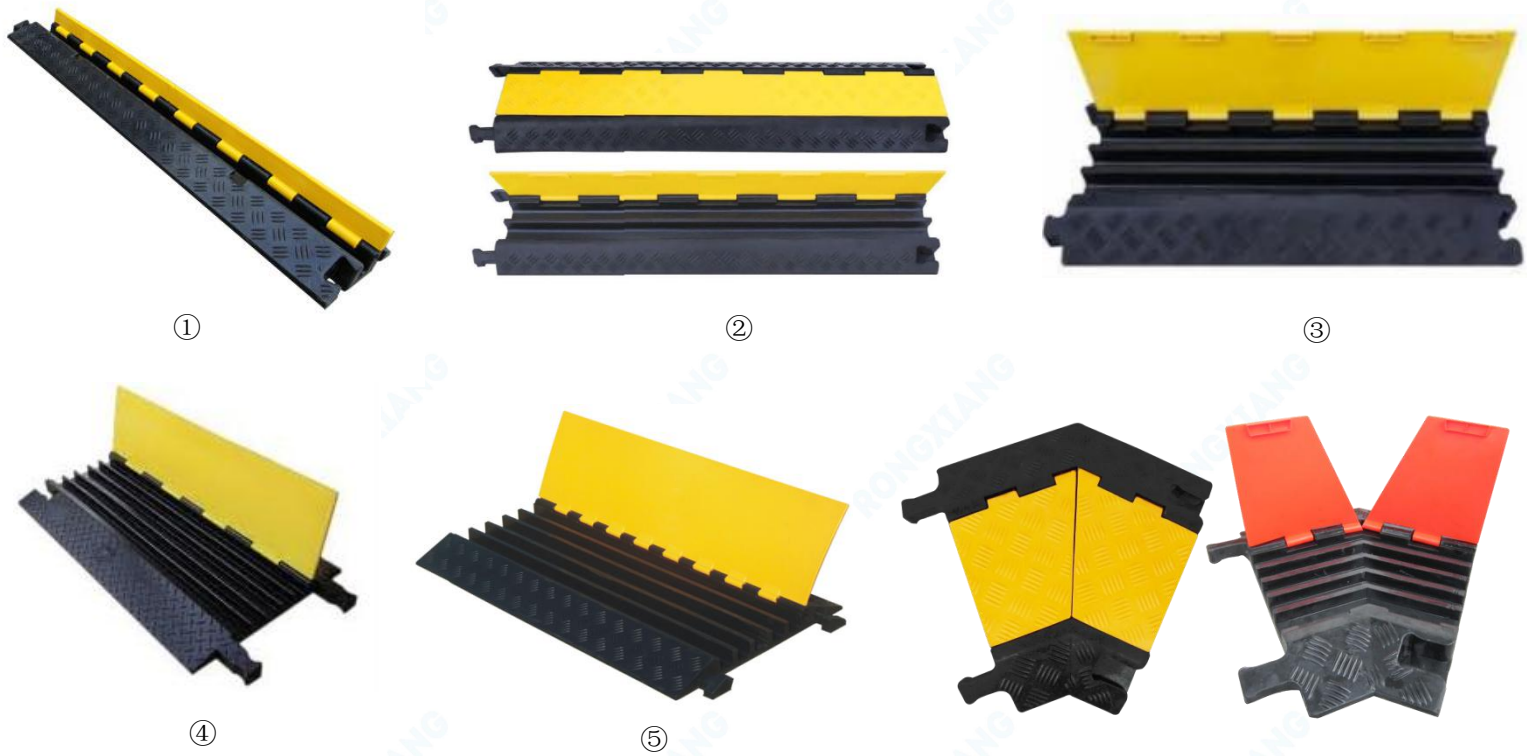

Model	Number	Size	Channel	Weight
RX-1XC-9R-21	①	990*210*45mm	1 Channel 30*30mm	5.3kg
RX-2XC-10R-10C	②	1000*250*50mm	2 Channel 45*30mm	7kg
RX-3XC-9R-11C	③	900*500*75mm	3 Channel 50*50mm	18kg
RX-4XC-9R-09B	④	900*500*60mm	4 Channel 45*40mm	15kg
RX-5XC-9R-07B	⑤	900*500*50mm	5 Channel 30*30mm	15kg

More details

LENGTH	Material
100/850/900/950/985/990/1000/1240mm	Rubber/plastic



Please call us for more details.

Rubber Kerb Hose Ramp

- High quality rubber cable hose ramp is used for protecting hose and cable from damage.With brilliant yellow part, is easy to see.
- Highly impact resistant.
- Easy installation and remove.
- High visibility for warning in day and night.
- Good protection for cable and wire.



Model	Material	Size	Channel Size	Weight	Bearing Capacity
RX-XC-8R-02	rubber	850*300*85mm	90*70mm	12kg	20tons
RX-XC-10R-21	rubber	1010*300*135mm	150*120mm	22kg	20tons
RX-XC-8R-01	rubber	850*300*125mm	100*90mm	19kg	20tons



Model	Material	Middle Size	End Size	Middle Weight	End Weight	Bearing Capacity
RX-XC-104A	rubber	600*300*100mm	300*300*100mm	11kg	3.5kg	20tons
RX-XC-104B	rubber	600*360*150mm	360*360*150mm	16kg	6kg	20tons
RX-XC-104C	rubber	600*450*200mm	450*450*200mm	30kg	14kg	20tons

Rubber Threshold Ramp

High quality rubber threshold ramp is used for helping move car or other things through entryways.

Make it easy to move heavy things inside or outside the high threshold.

Highly impact resistant.

Easy installation and remove.



Model	Material	Middle Size	End Size	Middle Weight	End Weight	Bearing Capacity
RX-LYP-6R-01	rubber	600*250*100mm	250*250*100mm	8kg	2.5kg	20tons
RX-LYP-6R-03	rubber	600*330*150mm	330*330*150mm	16.5kg	5kg	20tons



Model	Material	Size	Weight	Color
RX-OZDB-17	rubber	1070*610*65mm	19kg	Black
RX-OZDB-16	rubber	1080*620*85mm	22.5kg	Black

Chengdu Rongxiang Technology Co.,Ltd Wheel Stops/Chock



Model	RX-DWQ-5R-05E
Size	500*150*100mm
Weight	5kg



Model	RX-DWQ-5R-05A
Size	500*150*100mm
Weight	3.5kg



Model	RX-DWQ-5R-17B
Size	550*150*100mm
Weight	4.5kg



Model	RX-DWQ-5R-17D
Size	560*150*100mm
Weight	4.5kg



Model	RX-DWQ-6R-01F
Size	600*120*100mm
Weight	3.3/6kg

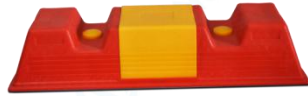

Model	RX-DWQ-5P-07B
Size	500*160*100mm
Weight	1.6kg



Model	RX-LYP-4R-01A
Size	480*410*110mm
Weight	13kg



Model	RX-ZTQ-2R-19A
Size	285*155*185mm
Weight	3.2kg



Model	RX-ZTQ-2R-15
Size	250*250*185mm
Weight	7kg



Model	RX-ZTQ-2R-12A
Size	240*170*195mm
Weight	4kg



Model	RX-ZTQ-2R-20
Size	210*250*220mm
Weight	6.5kg



Model	RX-ZTQ-3R-04
Size	210*250*220mm
Weight	6.5kg



Model	RX-ZTQ-2R-02A
Size	210*150*110mm
Weight	0.5kg



Model	RX-ZTQ-2R-01A
Size	200*174*147mm
Weight	0.9kg



Model	RX-ZTQ-1R-04A
Size	170*95*95mm
Weight	0.8kg



Wheel Stops

The wheel stops is used in parking lot and garages. It is made of high quality rubber, the yellow part is brilliant and reflective for have drivers' attention, no mater in day and night, indoor or outdoor. And the reflective part can be colorful, such as yellow, white, blue and so on.

The color is brilliant, non-fade, high visibility. Moisture & temperature resistant. Many anti-slip pattern design surface.



Model	Number	Material	Length	Width	Height	Weight	Packing
RX-DWQ-20R-01	①	Rubber	2000mm	150mm	100mm	17kg	Woven bag
RX-DWQ-18R-04A	②	Rubber	1830mm	150mm	100mm	14kg	
RX-DWQ-18R-04B	③	Rubber	1830mm	150mm	100mm	15kg	
RX-DWQ-17R-01A	④	Rubber	1780mm	140mm	100mm	10.5kg	
RX-DWQ-16R-03A	⑤	Rubber	1650mm	160mm	100mm	12kg	
RX-DWQ-16R-02	⑥	Rubber	1650mm	150mm	100mm	13.5kg	
RX-DWQ-9R-01B	⑦	Rubber	900mm	150mm	100mm	7kg	

More details

LENGTH	Material
470/490/500/600/750/900/1000/1200/1650/1780/1830/2000mm	Rubber/plastic



Please call us for more details.

Corner guards

Corner guard is used in parking lot and garages, hospitals, nursing homes, laboratories, hotel, schools, sports areas. It is made of high quality rubber, the yellow part is brilliant and reflective for have drivers' attention, no matter in day and night. And Installs easily only need anchor fasteners and glue.



Model	RX-HQJ-12R
Height	1200/900mm
Width	100mm
Thickness	9/10mm
Weight	3.2/2.2kg



Model	RX-HQJ-8R
Height	800mm/1000mm
Width	100mm
Thickness	8/10/12/14/16mm
Weight	1.8/2.2/2.8/3.6kg



Model	RX-HQJ-8P-17
Height	800/900mm
Width	80mm
Thickness	8/5mm
Weight	0.35kg



Model	RX-HQJ-06R
Height	600/800mm
Width	80mm
Thickness	10/12mm
Weight	1.5/1.8kg



Model	RX-HQJ-10R-09
Height	1000/800mm
Width	170/220mm
Thickness	50/35mm
Weight	4.5/2.0kg



Model	RX-FZT-10R-06B
Height	1000mm
Width	190mm
Thickness	90mm
Weight	16kg



Model	RX-FZT-10R-06C
Height	1000mm
Width	190mm
Thickness	90mm
Weight	17kg



Model	RX-FZT-10R-09
Height	1000mm
Width	200mm
Thickness	8mm
Weight	1.6kg



Please call us for more details.



Model	RX-HQJ-10R-02C
Height	1000mm
Width	100mm
Thickness	20mm
Weight	2.5kg

Model	RX-HQJ-10R-01A
Height	1010mm
Width	150mm
Thickness	13mm
Weight	4.9kg

Model	Material	Length	Width	Height	Weight	Packing
RX-HQJ-6R-07	Rubber	600mm	80mm	20mm	2kg	woven bag
RX-HQJ-8R-06E		800mm	100mm	8mm	1.3kg	
RX-HQJ-8R-09		800mm	120mm	20mm	2.5kg	
RX-HQJ-10R-02B		1000mm	100mm	12mm	3kg	
RX-HQJ-12R-03		1200mm	100mm	12mm	4kg	

PVC Traffic Cone



Model	RX-LZ-9P-01D
Height	900mm
Weight	4.3kg
Base Size	360*360mm



Model	RX-LZ-9P-01H
Height	900mm
Weight	5kg
Base Size	360*360mm



Model	RX-LZ-9P-01F
Height	900mm
Weight	4.7kg
Base Size	360*360mm



Model	RX-LZ-9P-01C
Height	900mm
Weight	4.2kg
Base Size	360*360mm



Model	RX-LZ-7P-22C
Height	750mm
Weight	2.35kg
Base Size	340*340mm



Model	RX-LZ-7P-23
Height	750mm
Weight	3.6kg
Base Size	360*360mm



Model	RX-LZ-7P-20
Height	720mm
Weight	3.3kg
Base Size	380*380mm



Model	RX-LZ-7P-08E
Height	700mm
Weight	2.3kg
Base Size	360*360mm



Completely made of new PVC material, be flexible and can bear press of cars. Will not broken if struck by hard things. Can be twisted and pressed in 360 degree.

Mixed with high quality pigment and anti-UV additive. Be sun-proof, waterproof, heat-resistant, cold-resistant, non-rimous, colorfast and so on. Color can not be fade within 2 years.

Highly reflective, good warning effects at both day and night.

Chengdu Rongxiang Technology Co.,Ltd Traffic Cone



Model	RX-LZ-7P-08C
Height	700mm
Weight	1.7kg
Base Size	360*360mm



Model	RX-LZ-7P-08J
Height	700mm
Weight	3.2kg
Base Size	360*360mm



Model	RX-LZ-7P-08J
Height	700mm
Weight	3.2kg
Base Size	360*360mm



Model	RX-LZ-4P-13
Height	470mm
Weight	0.9kg
Base Size	300*300mm

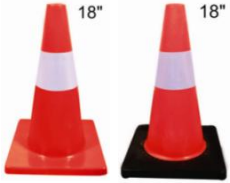

Model	RX-LZ-4P-08E
Height	450mm
Weight	1.1/1.65kg
Base Size	280*280mm



Model	RX-LZ-3P-02C
Height	300mm
Weight	0.6kg
Base Size	210*210mm



Model	RX-LZ-1P-01B
Height	150mm
Weight	0.3kg
Base Size	150*150mm



Model	RX-LZ-7P-11A
Height	700mm
Weight	1.5kg
Base Size	400*400mm



Model	RX-LZ-7P-11E
Height	700mm
Weight	2.8kg
Base Size	400*400mm



Model	RX-LZ-7P-11D
Height	700mm
Weight	2.7kg
Base Size	400*400mm



Model	RX-LZ-5P-15B
Height	500mm
Weight	1.5kg
Base Size	350*350mm



Model	RX-LZ-5P-15A
Height	500mm
Weight	1.1kg
Base Size	350*350mm



Model	RX-LZ-5P-10A
Height	500mm
Weight	1.5kg
Base Size	300*300mm



Model	RX-LZ-7R-11C
Height	700mm
Weight	2.7kg
Base Size	400*400mm



Model	RX-LZ-7P-01B
Height	700mm
Weight	2.2kg
Base Size	400*400mm



PE Traffic Cone



Model	RX-LZ-5P-07E
Height	500mm
Weight	2kg
Base Size	280*280mm



Model	RX-LZ-7P-25A
Height	750mm
Weight	2.5kg
Base Size	380*380mm



Model	RX-LZ-10P-01A
Height	1000mm
Weight	5kg
Base Size	490*490mm



Model	RX-LZ-7P-25D
Height	750mm
Weight	4.2kg
Base Size	380*380mm



Model	RX-LZ-7P-30
Height	750mm
Weight	4kg
Base Size	430*430mm



Model	RX-LZ-10P-02A
Height	1000mm
Weight	6kg
Base Size	500*500mm



Model	RX-LZ-5P-18
Height	500mm
Weight	3kg
Base Size	410*410mm



Model	RX-LZ-7P-29F
Height	750mm
Weight	4kg
Base Size	400*400mm

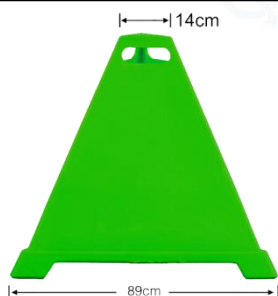

Model	RX-LZ-9P-09
Height	900mm
Weight	9kg
Base Size	890*890mm

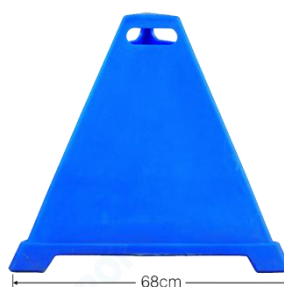

Model	RX-LZ-6P-21
Height	600mm
Weight	4kg
Base Size	680*680mm



EVA Traffic Cone

Be made of high quality EVA with rubber base, can be used in heat and cold environment. With high visible reflective strip is good for safety warning. 500mm and 700mm high with red, orange and black for choosing. With UV inhibitors on both the surface and inner layer.



RX-LZ-5P-12



RX-LZ-7P-14A



RX-LZ-7P-14B

Model	Material	Height	Base Size	Reflective Strip
RX-LZ-5P-12	EVA	500mm	325*325mm	140mm
RX-LZ-7P-14A	EVA	700mm	425*425mm	140+45mm
RX-LZ-7P-14B	EVA	700mm	425*425mm	415mm



Collapsible Cone



ABS Base		
Model	Base Size	Height
RX-SSLZ-9P-01	42X42X6cm	90CM
RX-SSLZ-7P-01	30.5X30.5X5cm	70CM
RX-SSLZ-6P-04	30.5X30.5X5cm	65CM
RX-SSLZ-6P-01	30.5X30.5X5cm	60CM
RX-SSLZ-5P-04	30.5X30.5X5cm	55CM
RX-SSLZ-5P-01	24.4X24.4X3.75cm	50CM
RX-SSLZ-4P-05	24.4X24.4X3.75cm	45CM
RX-SSLZ-4P-01	24.4X24.4X3.75cm	40CM
PP Base		
RX-SSLZ-7P-03	31X31X3.5cm	70CM
RX-SSLZ-7P-02	30.6X30.6X3.8cm	70CM
RX-SSLZ-6P-05	30.6X30.6X3.8cm	65CM
RX-SSLZ-6P-02	30.6X30.6X3.8cm	60CM
RX-SSLZ-5P-05	30.6X30.6X3.8cm	55CM
RX-SSLZ-5P-02	24.5X24.5X3.6cm	50CM
RX-SSLZ-4P-07	24.5X24.5X3.6cm	45CM
RX-SSLZ-4P-03	24.5X24.5X3.6cm	40CM
RX-SSLZ-3P-05A	19X19X4.5cm	35CM
RX-SSLZ-3P-03B	19X19X4.5cm	30CM
Sport Cone		
RX-YDLZ-01	35*35cm	68.6CM
RX-YDLZ-02	35*35cm	68.6CM



Be collapsible, retractable, reflective, portable. With Led light and high quality reflective strip.

Cone Topper



The cone topper is to place on top of traffic cone. They are solid injection molded, polypropylene material, heavy duty 1.5MM thickness, fit any standard traffic cone, are easy to install, no tools needed, are solvent, corrosion, and chemical resistant, are graffiti resistant, will not rust, have zero profile, and are UV rated 2-3 years indoor & outdoor durability.



Traffic Cone Bar

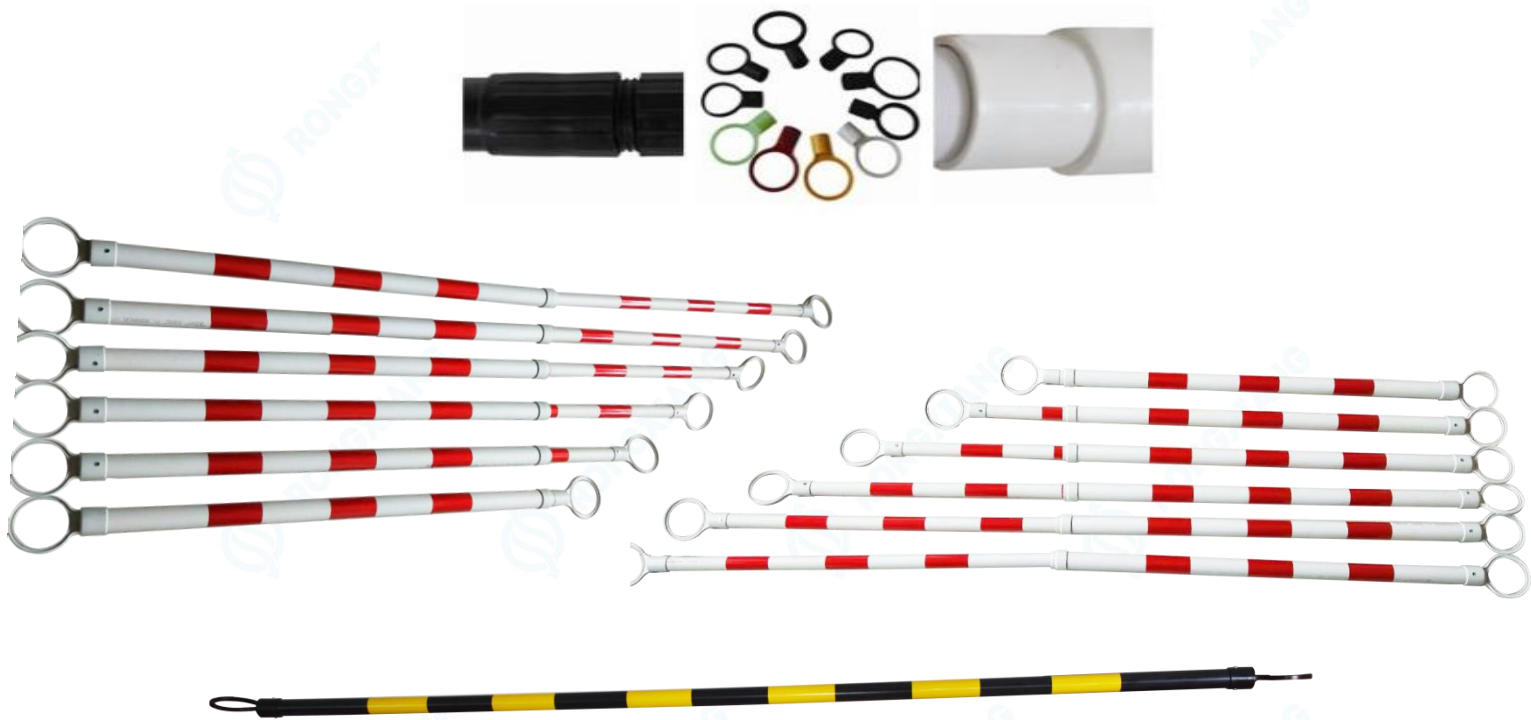

Material: ABS

Name:Cone Bar

Package:Woven Bag

Application: Traffic cone.

Color:Orange/red/green/white etc.

Product Description

It's light weight and extremely portable. Easy to set up or remove, providing an instant and inexpensive barrier to hazardous or controlled access areas. Made with high quality industrial grade material.

Items No.	Material	Type	Stripe Length	Diameter	Body Color
RX-LJ-12	ABS	Non-Retractable	2000mm	35mm	Orange/red/green/white
RX-LJ-09	ABS	Non-Retractable	1000/2000mm	34/40mm	Orange/red/green/white
RX-LJ-06	ABS	Retractable	1200/2400mm	40mm	Orange/red/green/white
RX-LJ-08	ABS	Retractable	3000mm	55mm	Orange/red/green/white

Solar Traffic Sign

We can produce the solar traffic signs according to customer request.

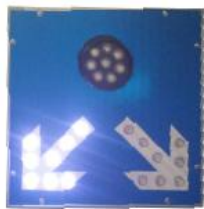

RX-BZP-5M-01



RX-BZP-4M-02



RX-BZP-6M-04



RX-BZP-6M-06



RX-BZP-8M-02



RX-BZP-6M-05



RX-BZP-6M-04A



RX-BZP-9M-01



RX-BZP-12M-02

400



RX-BZP-7M-02



RX-BZP-6M-04B

Model	Sign	Size/Diameter
RX-BZP-5M-01	customized	500*500*65mm
RX-BZP-4M-02	customized	400*600*65mm
RX-BZP-6M-04	customized	600*600*65mm
RX-BZP-6M-06	customized	600*800*65mm
RX-BZP-8M-02	customized	800*800*65mm
RX-BZP-6M-05	customized	600*65mm
RX-BZP-7M-02	customized	700*700*65mm
RX-BZP-9M-01	customized	900*900*65mm
RX-BZP-12M-02	customized	1200*400*65mm
RX-BZP-6M-04A	customized	600*600mm
RX-BZP-6M-04B	customized	600*600mm



RX-JSD-S-09

Basic Info.

Model NO.:RX-JSD-S-09

Type: Warning Light

Material:PP+ABS

Function: Flash

Flash rate: 65+_5 times/minute

Power: 6V 4 R25 Battery

Colors Available: Yellow, Red,Blue,Green,White Can customized.

Product Description

The warning light can flashing in the dark area. And it is closed in white time by itself. It is can warning people when the road have working or the road is bad.

Features:

The light can be constant and flash.

High visibility and long view distance.

Made of high quality, the life is long.

Water proof design, can be used in the rainy day.





RX-JSD-S-17



Basic Info.

Model NO.:RX-JSD-S-17

Type: Solar traffic light

Packing:12pcs/ctn

Packing size: 52.5X36X39.5cm

7" lens and PP body

Normal 2 LED flashing light standard flash rate is 65+-10 times/min

Solar panel:high quality silicon solar cell

Power:0.4 W rechargeable 2.4 AA Ni-Mh Battery

Function:flash and close

With metal bracket

Product Description

In the sunny days, sunlight converts into electricity with solar panel and charge battery; in the evening, it automatically turns on at dusk Turn off at daytime.



RX-JSD-S-12



Basic Info.

Model NO.:RX-JSD-S-12

Type: Solar traffic light

Material: 7" Lens and PP body

Packing:12pcs/ctn

Packing size: 55*33.5*31cm

Function: Flash, long bright, closed.

Power: 0.4w rechargeable, 2.4v AA Ni-Mh Battery

Flash rate: 65+ _10 times/min

Color:Many kinds.

Product Description

In the sunny days, sunlight converts into electricity with solar panel and charge battery; in the evening, it automatically turns on at dusk Turn off at daytime.

Features:

The light can be constant and flash.

High visibility and long view distance.

Made of high quality, the life is long.

Water proof design, can be used in the rainy day

Note: if you want to use it in the daytime, you can use some shades to cover the top part.

Heavy Duty Barricade Warning Light

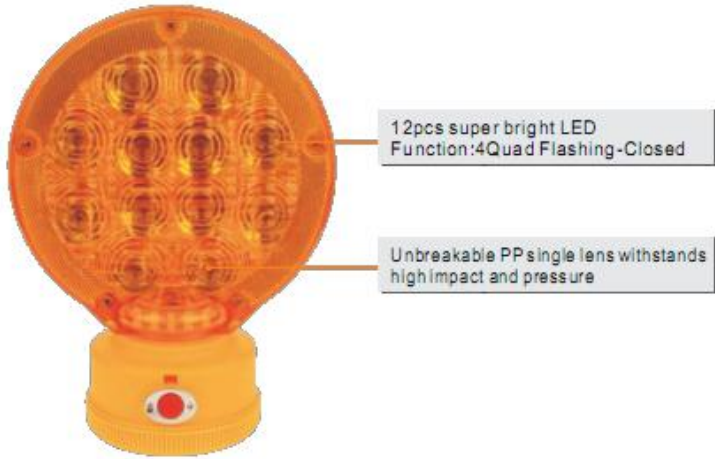

TYPE B One-sided Visibility Barricade Light

Are available in Type B ,3 Volt D-Cell, or A/C 6 Volt.

12pcs super bright LED internal light source & Flash mode is :
4-Quad Flashing--Off

The twelve convex lens in front of the LEDS can enlarge the output
of the light source.

5 times brighter than normal lights



Use like



Hot sale!



Solar Warning Light/Lamp

Solar Powered
 Diameter: 9cm
 Height: 16.5cm/15.5cm
 Energy: green led warning strobe light 3.2 Volt 600 mAh
 Illumination: 4 High Intensity Super Bright LED
 Cover Material:PC
 Function : flash- close
 6 Hour Sun Charged: Operates 60 Hours (Flash Mode)
 Photo control: Automatic on at Dusk; Off at Dawn
 Colors Available: Yellow, Red,Blue,Green.
 The flashing function is flashing - close. Normally takes 15 hours to be charged, can be used for 50 hours. Lifetime is 3 to 5 years, (depending on environmental factors). Visibility 200 m in the darkness , photo control, automatic on at dusk ,off at dawn, save energy, solar powered warning light friendly to the environment.





RX-JSD-S-07



RX-JSD-S-09



RX-JSD-S-27



RX-JSD-S-28



RX-JSD-S-30



RX-JSD-S-31



RX-JSD-S-32



RX-JSD-S-33



RX-JSD-S-33A



RX-JSD-S-33B



RX-JSD-S-33C

Item	Size(mm)	Battery	Flash frequency	LED
RX-JSD-S-07	160*70*320	6V 4R25	65+5 times/min	Φ 5*2
RX-JSD-S-09	182*98*370	6V 4R25	65+5 times/min	Φ 5*2
RX-JSD-S-27	188*95*403	6V 4R25	65+5 times/min	Φ 5*2
RX-JSD-S-28	160*70*320	6V 4R25	65+5 times/min	Φ 5*2
RX-JSD-S-30	201*84*365	6V 4R25	65+5 times/min	Φ 5*2
RX-JSD-S-31	134*125*247	6V 4R25	65+5 times/min	Φ 5*8 or H 1*1
RX-JSD-S-32	270*110*70	6V 4R25	65+5 times/min	Φ 5*4
RX-JSD-S-33	178*93*337	Solar/Rechargeable 1.2v/2.4vA A Ni-Mh	65+5 times/min	Φ 5*2/4

MODEL	MATERIAL	DIAMETER	HEIGHT	LED LIGHT	SOLAR PANEL
RX-JSD-S-33A	PC shell, ABS base	140mm	180mm	8yellow	5V 190mA
RX-JSD-S-33B	PC shell, ABS base	140mm	180mm	8red	5V 190mA
RX-JSD-S-33C	PC shell, ABS base	140mm	180mm	8red+8blue	5V 190mA

Traffic Lane Separator

Traffic Lane Separator is used in roadway for traffic safety. Can be quickly and easily put in position in all weathers.

- No collection of water.
- Easy to remove.
- Non-fade.
- High visibility.
- High Impact Resistance.
- Moisture & temperature resistan



Model	Material	Length	Base Width	Height	Weight
RX-FDT-10R-02	Rubber	1000mm	250mm	450mm	11.3kg
RX-FDT-10R-01A	Rubber	1000mm	250mm	350mm	11.3kg



Model	Part	Length	Width	Thickness	Post Height	Post Diameter	Weight
RX-FDT-11R-01	Middle	1120mm	250mm	85mm	900mm	75mm	17kg
	End Cap	500mm	250mm	85mm			7.5kg
Model	Part	Length	Width	Thickness	Panel Height	Panel Width	Weight
RX-FDT-11R-01A	Middle	1120mm	250mm	85mm	750mm		17kg



T-Shape Connector



Design for Post



End Cap



Model	RX-GLD-4P-01
Length	400mm
Width	145mm
Height	170mm
Weight	2kg



Model	RX-FDT-06
Length	1000mm
Width	150mm
Height	50mm
Weight	7.0kg



Model	RX-FDT-3R-01
Height	330mm
Base Size	210*150mm
Bearing Weight	20tons
Weight	1.5kg



Model	RX-FDT-P-01
Height	330mm
Base Size	210mm
Weight	0.52kg



Model	RX-FDT-2R-03
Height	245mm
Base Size	250mm
Weight	1.3kg

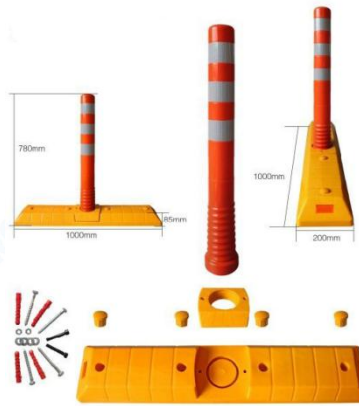

Model	Base Length	Base Width	Base Thickness	Post Height	Post Diameter	Weight
RX-FDT-10R-04	1000mm	200mm	85mm	780mm	80mm	4.5kg

Road Barrier

The barrier is lightweight, is easy to loading and installation. It is made of high quality material, will not damage or scratch floors.

Can be filled with water for heavy use.

Color is brilliant, non-fade.

Moisture & temperature resistant.



Model	Material	Bottom	Height	Weight
RX-GLD-8P-02	Plastic	360*360mm	800mm	1.8kg



RX-GLD-5P-05



RX-GLD-5P-02



Model	RX-GLD-5P-05
Bottom Width	360mm
Height	560mm
Length	560mm
Top Width	150mm
Weight	3kg
Model	RX-GLD-5P-02
Bottom Width	400mm
Height	560mm
Length	500mm
Top Width	170mm
Weight	3.5kg

Water Filled Barrier (Color can be customized)



Model	RX-SM-14P-02B
Size	L: 1400mm Upon W: 170mm Down W: 330mm H: 800mm
Net Weight	7-7.5kg/pc(400kg water)

Model	RX-SM-15P-04
Size	L: 1500mm Upon W: 180mm Down W: 380mm H: 800mm
Net Weight	9/10/12.5kg/pc(250kg water)

Model	RX-SM-20P-01B
Size	L: 2000mm Upon W: 145mm Down W: 400mm H: 800mm
Net Weight	19kg/pc(400kg water)



Plastic Safety Crash Bucket



RX-FZT-8P-02B



RX-FZT-8P-04B



RX-FZT-9P-04C

Model	Material	Diameter	Height	Weight	Water Capacity
RX-FZT-8P-02B	Plastic	580mm	800mm	5kg	250kg
RX-FZT-8P-04B	Plastic	580mm	820mm	5kg	250kg
RX-FZT-9P-04C	Plastic	900mm	920mm	12.5kg	400kg



Model	Material	Vessel Head	Vessel Tail	Height	Weight	Water Capacity
RX-FZT-9P-01	Plastic	900*900*900mm	450*900*900mm	900mm	38kg	600kg



Model	RX-FZT-005
Height	1000mm
Diameter	460mm
Weight	15kg



RX-JST-11P-02



RX-JST-10P-02

Model	Material	Diameter	Height	Weight
RX-JST-11P-02	Plastic	850mm	1100mm	15kg
RX-JST-10P-02	Plastic	400*505mm	1000mm	4.75kg



Warning Posts/Bollards

Warning post is used in railway, parking, Road. It is made of high plastic material and rubber, the color is brilliant and with high quality reflective part for having drivers' attention, no matter in day and night.

- Non-fade.
- High Impact Resistance.
- Moisture & temperature resistant.



Model	RX-JSZ-11P-01B
Height	1100mm
Base Weight	6/8kg
Base Size	420*420mm
Post Weight	0.7kg

Model	RX-JSZ-8P-01C
Height	800mm
Base Weight	1.9kg
Base Size	100*100mm
Post Weight	0.65kg

Model	RX-JSZ-7P-13E
Height	750mm
Weight	0.7kg
Base Size	200*200mm



Model	RX-JSZ-9P-03
Height	950mm
Weight	3kg
Base Size	260*260mm

Model	RX-JSZ-7P-05C
Height	750mm
Weight	0.8kg
Base Diameter	200mm



Model	RX-JSZ-4P-04C
Height	450mm
Weight	0.6kg
Base Diameter	200mm



Model	Material	Height	Diameter	Thickness
RX-JSZ-9M-02	304 stainless steel	900mm	168mm	3mm
RX-JSZ-12M-01	304 stainless steel	1000mm	90mm	4mm
RX-JSZ-9M-03	304 stainless steel	1200mm	90mm	5mm
RX-LKB-07A	PVC	1250mm	100*120mm	

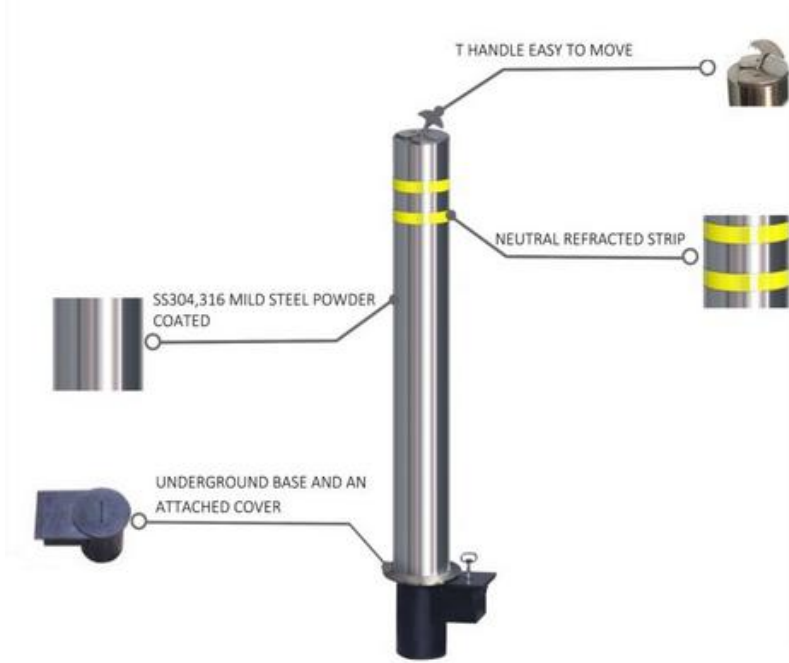

Model	Material	Height	Diameter	Reflective tape
RX-JSZ-9M-04	304 stainless steel	900mm	114mm	2*3cm
RX-JSZ-9M-04A	steel	900mm	114mm	2*3cm



Model	Length	Weight	Base Diameter
RX-JSZ-5P-02	500mm	2.4kg	260mm
RX-JSZ-8P-02B	800mm	2.7kg	260mm
RX-JSZ-12P-01	1200mm	3kg	260mm



Model	Material	Length	Diameter	Shape
RX-JSZ-6P-01	PE/PP/PVC	60 / 90 / 120 / 150 / 180 / 210 / 240cm or customized	23/30/35/40/45/50mm or customized	Square or Round





Model	Material	Height	Diameter	Shape	Base Size
RX-JSZ-10P-02	TPU	1000mm	80mm	Round	200*200mm
RX-JSZ-9P-04	TPU+PE	900mm	70/50mm	Round	200mm
RX-JSZ-10P-06	TPU+PE	1050mm	70/50mm	Round	200mm
RX-JSZ-12P-03	TPU+PE	1200mm	70/50mm	Round	200mm



Model	RX-JSZ-11P-01E
Height	1100mm
Weight	6.4kg
Base Size	420*420mm



Model	RX-JST-7P-02
Height	720mm
Weight	1.3kg
Base Size	200mm



Post Sign

- High flexibility.
- Different colors for choosing.
- Weather Resistant, Water Proof.
- Easy to carry and install.
- Fit for all size of traffic cone.
- Any words can be customized.
- Be made of PVC



Model	Shape	Size	Weight
RX-PZ-01	round	200mm	0.45kg
RX-PZ-02	square	210*297mm	0.45kg

More details

Height	Material
450/500/600/750/800/900/950/1000/1100/1200mm	Rubber/plastic



lease call us for more details.

Warning Board



Model	RX-JSB-11P-06
Height	1100mm
Weight	24kg
Base size	500*500mm

Model	RX-JSB-11P-05
Height	1100mm
Weight	34kg
Base Size	700*400mm

Model	RX-JSB-8P-01
Height	800mm
Weight	8kg
Base Size	370*320mm



Model: RX-WL-14
 Length: 1950mm
 Width: 50mm
 Height: 1000mm
 Weight: 11.5kg
 Material: PE

This barrier is blow-moulded, including one barrier and two rotatable legs

Plastic expandable barrier



MODEL	MATERIAL	FOLD LENGTH	EXPAND LENGTH	HEIGHT	WEIGHT	FEATURE
RX-WL-25	Plastic PVC	390mm	2500mm	960mm	2.7kg	Can filled with water
RX-WL-20	Plastic		1000mm	900mm	2.5kg	

Other plastic expandable barrier



Metal expandable barrier



Product Description

Model NO.:RX-WL-23
 Type:Expandable Barrier
 Surface: Power Coated
 Size:L450xW300xH1020(folded)
 L3000xW300xH1020(expanding)
 Color: Red, White, Yellow, Black, etc.



- Can be Expanded.
- Be used in both indoor and outdoor.
- Color is brilliant, non-fade.
- Moisture & temperature resistant.

MODEL	MATERIAL	FOLD LENGTH	EXPAND LENGTH	HEIGHT	WEIGHT	PACKING
RX-WL-23	Steel tube/aluminums slat /Wheel	450mm	3000mm	1020mm	11.6kg	Fiberboard carton



Our traffic barrier have many models. If you have demand please contact with us.

Metal crowd control barrier/portable barricades,/pedestrian barriers



Product Description:

It is use for Traffic road control, Road isolation belt, Limit vehicles
 Concert, Outdoor activity, Sport ground
 Highway, Public activities for crowd control
 Crowd Control Barriers provide safety and security for patrons and the general public.
 RONGXIANG provides the best crowd control barriers on the market.
 Heavy Duty Crowd Control / Pedestrian Barriers are designed for long life and regular use

They are fully hot dipped galvanized after welding.
 Road barrier is weather resistant and durable.
 The barriers are light and easy to handle
 Road barrier is strong enough for crowd control.

The feet can be made as removable which makes transportation and storage much easier and more effici



Model	RX-WL-22
Material	metal
Panel size	1.1x2.1m, 1.1x2.2m, 1.1x2.5m (Or customized)
Outer tube	25mm,32mm,38mm,42mm,48mm
Frame thickness	1.3mm,1.4mm,1.5mm, 1.8mm, 2.0mm
Inner tube	12mm,14mm,16mm,20mm,25mm O.D.
Inner tube thickness	1.0mm, 1.2mm, 1.5mm,
Spacing	60mm,100mm,120mm,150mm,190mm&200mm
Feet	U / Y / flat ,bridge ,cross etc.
Surface treatment	hot dipped galvanized,electro galvanized, spray paint, powder coated



Solar Road Stub



RX-DD-S-15



RX-DD-NS-26

MODEL	MATERIAL	LENGTH	WIDTH	HEIGHT	PACKING
RX-DD-S-15	Aluminum alloy	113mm	109mm	23.5mm	Carton box
RX-DD-S-14	Aluminum alloy	110mm	95mm	23mm	Carton box
RX-DD-S-19	Aluminum alloy	120mm	40mm	23mm	Carton box
RX-DD-NS-26	Glass	100mm	100mm	50mm	Carton box

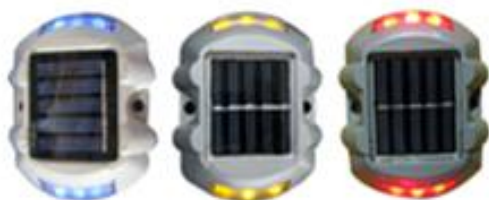

RX-DD-S-14



RX-DD-S-19

Road Stub

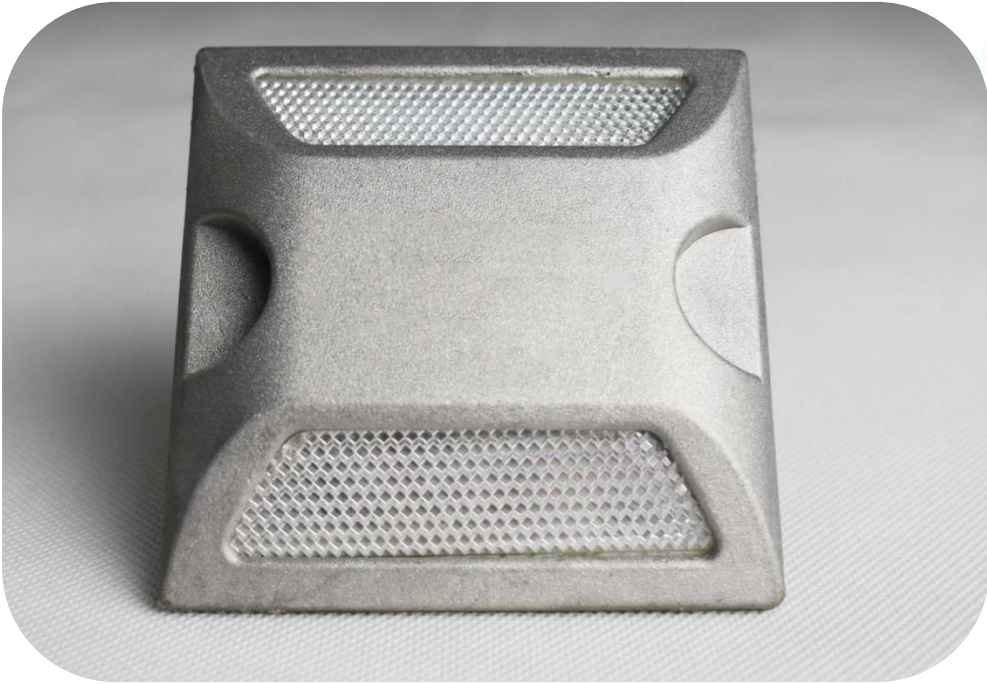

MODEL	MATERIAL	LENGTH	WIDTH	HEIGHT	PACKING
RX-DD-NS-25	Plastic	100mm	100mm	50mm	Carton box
RX-DD-NS-24	Plastic	100mm	100mm	20mm	Carton box
RX-DD-NS-03	Plastic	100mm	100mm	18mm	Carton box

Solar radar traffic limit sign



2 digits Products detail:

- 1.Speed Limit Sign Size:600x600x2mm
- 2.Speed Display size:700x700mm
- 3.The display screen size:340x450mm
- 4.The show:2 digits
- 5.The battery and the radar are put into the speed display box.
- 6.Speed detection distance:100-300m
- 7.LED life:>=100000hrs
- 8.Power:solar panel 80W
- 9.Weatherproof:IP65
- 10.Control 2-3 lanes
- 11.Life span > 5 years
- 12.Like the picture:The speed limited can set up :10km/h, 20km/h-80km/h
- 13.All the parts can be used for installation 75-76mm pole.
14. battery after full charge can use one month (the wet weather continuous).
If the weather good the time will increase.

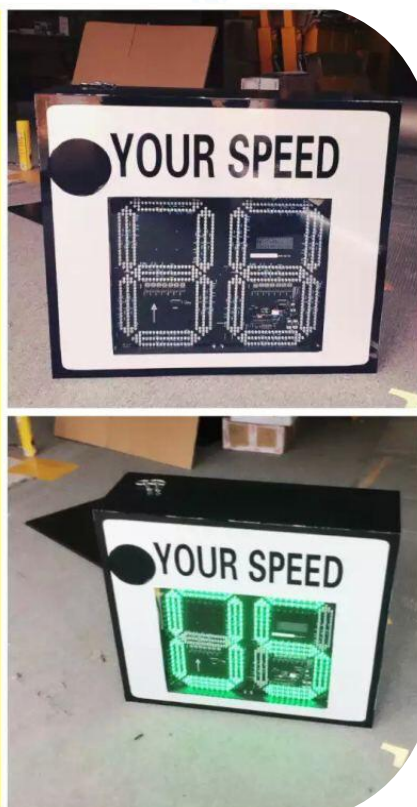
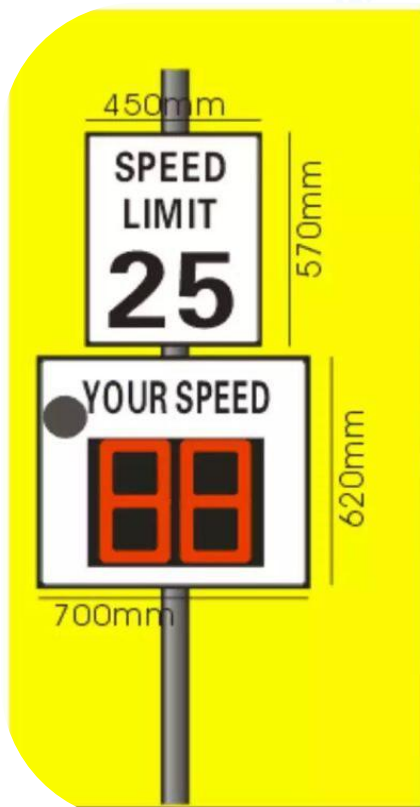

Outdoor Convex Mirror

- 1.PC convex mirror,Acrylic convex mirror,Stainless steel mirror.
- 2.All mirrors could be customized per customer's request.
- 3.Suitable for different curves,road junction,conveyors,parking lot, large scale supermarket,outdoor areas and supervision.
- 4.Can anti-burglary,expand the view on road corner,driveway,warehouse.



Mirror Material	Diameter(cm)
PC	30/45/60/80/100
PMMA	30/45/60/80/100/120

Concave Mirror

Concave mirror just what teachers have been looking for. A low cost, quality mirror which captures the imagination. Hold the concave side close to your face and watch what happens to your image as you move the mirror away from you.



Diameter(cm)	Detail
30	Two sides,front convex ,back concave One side,front convex or concave
61	Two sides,front convex ,back concave One side,front convex or concave

Indoor Convex Mirror

- 1.Suitable for all indoor security applications.
- 2.Used for warehouse doorways,conveyors,hoppers,crossovers, car parks,hotel,indoor supervision,blind corners.
- 3.Color and size could be customized.



Mirror Material	Diameter(cm)
PC	30/45/60/80
PMMA	30/45/60/80

Dome Mirror (Spherical Mirror)

Usage:

Widely used to eliminate blind spots and improve surveillance in retail stores, parking lots,warehouses.



Mirror Material	°	style	Diameter(cm)
PMMA	45°	1/8	50/60/70/80/90/100/120
	90°	1/4	30/40/50/60/70/80/90/100/120
	180°	1/2	30/40/50/60/70/80/90/100/120
PC	45°	1/8	45/66/81/91
	90°	1/4	45/66/81/91
	180°	1/2	45/66/81/91

Under Vehicle Search Mirror

- Light weight design,Aluminum telescopic handle
- Extra deep convex mirror ensures a maximum viewing area.
- Light could be attached to the rod.
- Light place also could be adjusted.
- There is wheel about car mirror.
- The pole length could be customized



Mirror Material	Diameter(cm)
PC	30



Safety Vests

- Enhance visibility as well as safety apparel
- We supply kinds of safety vests. Europe Style Safety Vests, Children Vests, Dog Vests, Running Vests, Led Vests.
- Our Customize Service: Color, Packaging, Front Closed Way, Tags, Size, Logo.
- All could be customized per customer's request.



Fabric	100%polyester solid fabric
Color	Fluo Yellow or Customized color
Closure	Zipper, Velcro or customized
Certification	ENISO2047:2013, EN471, ANSI/ISEA 107-2010
Packaging	1pc/opp bag, 100pcs/ctn



Warning Tape



Reflective Tape Type:

1. Crystal plaid with adhesive back
 2. Reflective Type
 3. Double Color Reflective Type
 4. Arrow Reflective Type
 5. Engineering grade reflective film
 6. Engineering grade double color reflective film
 7. High strong reflective film
 8. High Strong Crystal plaid
 8. Superior Micro prism reflective film
 10. 70cm crystal plaid cone cover
 9. Crystal plaid film for safety crash bucket
 10. Crystal plaid film for corner guard
 11. Crystal plaid film for car
 14. Arrow reflective film
- Application: reflective vest, coat, bag, sport clothes
 Size: 5cm *100m; 2.5cm*100m; 1m *50m or customized

Characteristics

- High Quality,High intensity,
- Water proof, Cold-resistant.
- Good thickness, High brightness

Material	Width*Length
PVC	1.24m*45.7m, 1m*50m (customized)
PET	
PMMA	



Warning Signage

Use :Highway,Plaza,Railway,Road,Train station,Hotel,Tower,Factory.Acid Rain

Kinds of Signs:

1.Danger signs 2.Mandatory signs 3.Customize signs 4.Warning signs 5.Prohibition&No smoking signs 6.Fire signage 7.Notice Information signs 8.Emergency Exit signage



Size	60cm or Customized
Shape	Square,triangle,round or customized
Base Diameter	300-360mm
Thickness	1-3mm
Color	Red,white,blue,black,green or customized
Material	Iron, brass, copper, aluminum, stainless steel,zinc alloy
Technical	Hot cut, laser cut, embossed, embroidered

Characteristics

- Over 300 messages.
- UV inhibitor
- Designed for years of use
- Can be installed onto a post, fence or wall
- Meet Australian standard
- Different plate size available
- With stand extreme conditions
- Can be design to attach to different objects.
- Anti UV and Anti acid rain

Umbrella Cone

- 1.Unfold is umbrella cone,every direction can see the reflecting icon.
- 2.After folded the volume is very small,convenient to carry.
- 3.Triangle structure,stable and not easy to dump.
- 4.Plastic tube,warning light on the top
- 5.Sign imprinted with multilingual caution message
- 6.Collapsible, automatically deployed cone
- 7.Wall-mounted, shatter proof
- 8.Durable material withstands abuse



Pop-Up Safety Cone

- Color:Yellow
- Size:55.5*48*48cm/77*57*57cm
- Material:Spring steel and nylon cloth
- Packing: 24pcs/ctn or 12pcs/ctn

Floor sign

High visibility.

Different colors and sizes for choosing.

Good quality for long term application.

The words printing can be customized accord to your requirement.



Model	Material	Height	Width	Weight
RX-AZP-6R-02	PP	640mm	300mm	0.65Kg
RX-AZP-6R-01	PP	610mm	295mm	0.636kg
RX-AZP-5R-01	PP	600mm	300mm	0.52kg



Model	RX-LZ-7P-21
Height	750mm
Weight	1.2kg
Base Size	280*280mm



Model	RX-LZ-5P-20
Height	520mm
Weight	1.2kg
Base Size	310*310mm

Wheel Measurer

Attentions

1. Operate it according to the instructions before work, set the counter to zero
2. Keep straight to ensure the accuracy of measurement when measuring straight line.
3. Jagged surface will reduce the accuracy of measurement.
4. Don't work in the rain for a long time.
5. Don't work in the environment of high temperature for a long time.
6. Do not use the instrument as children toys, avoid unnecessary damage.



Characteristics

- Max measuring range:99999.9m,
- With the metric system transformation function
- Diameter of wheel:318mm
- Accuracy:0.5%

Model	Pack dimen(mm)	QTY(pcs)	G.W/N.W(kg)
RX-CJL-01	68*51*51	6	11kg/10kg
	68*51*51	12	20kg/19kg

Warning Triangle

The triangle warning sign is used to warn and have drivers' attention in the event of a breakdown or accident. It is foldable and packed by a plastic box, easy to carry and installion. Fluorescent, retroreflective, high visibility.

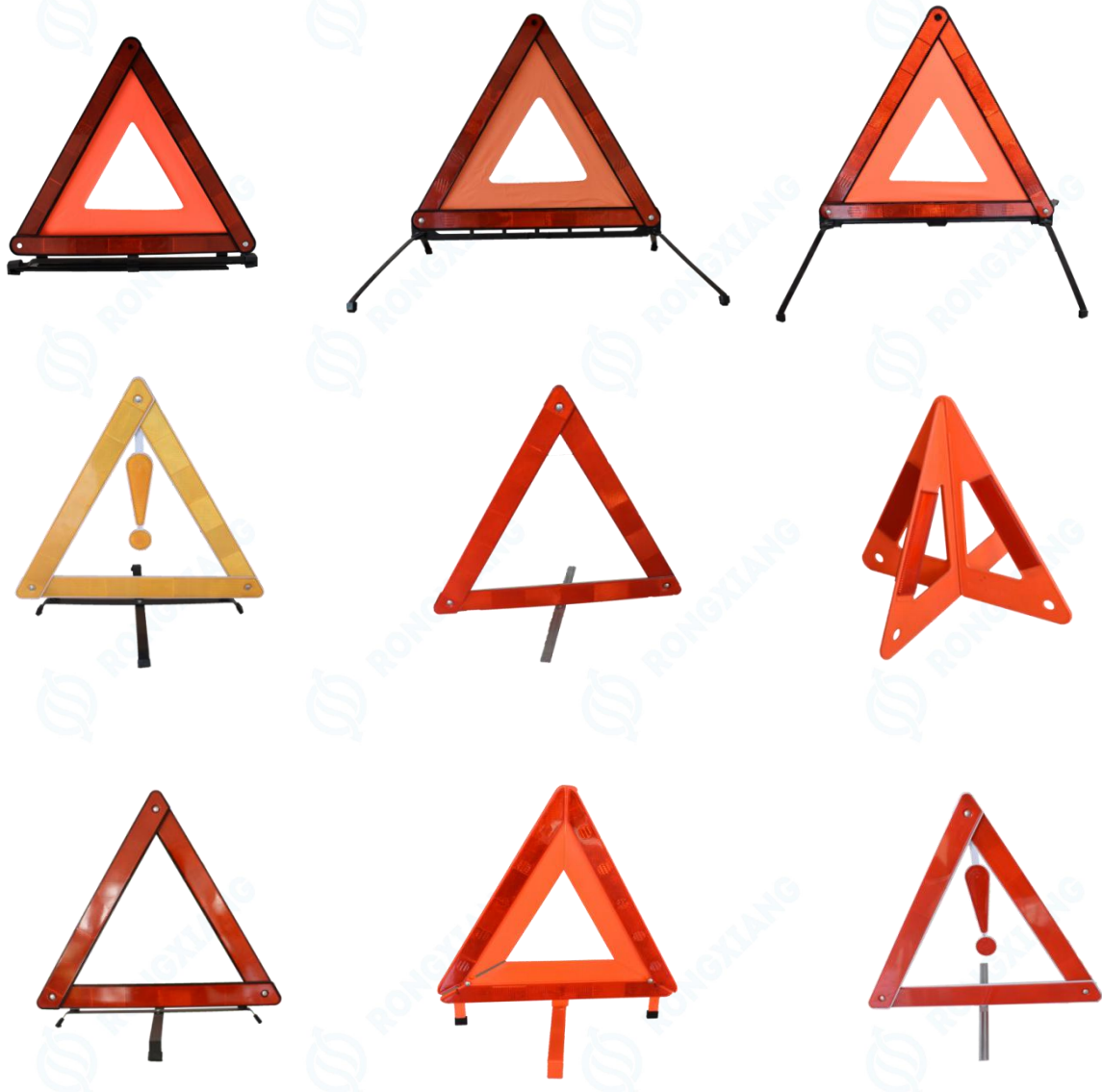

Model	Size	G.W/N.W
RX-JSP-03	420mm	350g/297g
RX-JSP-05	430mm	410g/350g
RX-JSP-07	430mm	550g/490g
RX-JSP-02	420mm	355g/305g
RX-JSP-04	420mm	200g/180g
RX-JSP-01	260mm	145g

Wheel Clamp and Parking Lock



Use Tip:

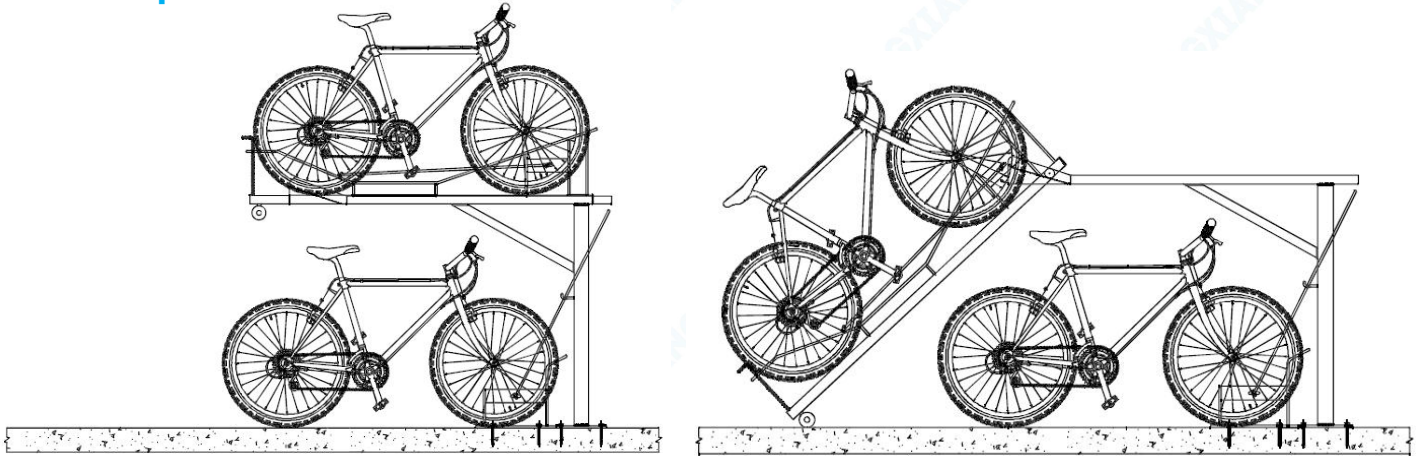

Produce actual item:



The Bicycle Parking system use the customized rack can easy to park bike. It is customized two-layer can save space. We also produce the simple bicycle rack.

It is use for some public parking .Such as gym,park.....and so on.

It is can protective your bicycle and add lock.....Have wheel easy to moving down.

Folding Rack

The folding rack can use for warehouse /shop/kitchen.....We can customized the folding rack....
No matter what size you need. It is can fold easy to moving.

Actual products:

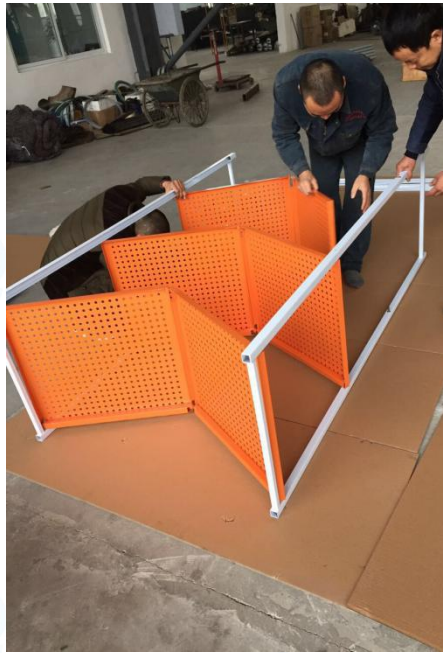

Chengdu Rongxiang Technology Co.,Ltd



Our site:

www.rongxiangcn.com

rongxiangcn.en.made-in-china.com

Add:

718,No,10,1 North,2 Ring,Chengdu,China.

Tel:

86-28-68373166/68373188

Fax:

86-28-68373166-804

Postal code:

610031



Facebook



Made In China