



此二维码为联系方式，请扫描

Two-dimensional code is contact , Please scan it

传承实业（香港）有限公司  
ELEHK(HK)LIMITED  
东莞市传承塑胶电子有限公司  
ELEHK PLASTIV ELECTRON CO.,LTD

地址：中国广东省东莞市长安镇乌沙建安路351号  
ADD: King Yip Square Industry District, 351 Jian An Road Wusha  
District, Changan Town, Dongguan City, Guangdong China.  
Tel: +86-769-85385386/7    FAX: +86-769-89321081  
MB: +86-13929256709    E-mail: David@elehk.com  
Http: //www.elehk.com



专业塑料紧固件制造商

Professional manufacturer of plastic fasteners

传承实业（香港）有限公司  
东莞市传承塑胶电子有限公司

elehk®

传承实业(香港)有限公司—东莞市传承塑胶电子有限公司位于世界制造业名城—广东省东莞市长安镇。自2008年成立以来，专注于塑料紧固件类产品的技术开发和配套应用领域。我们的产品有塑料膨胀管，塑料膨胀壁虎，塑料膨胀螺丝，塑胶膨胀螺栓，塑料胶塞，塑料锚栓，塑料盖帽，螺母保护帽，螺母防尘帽，螺丝保护帽，内外六角盖帽，塑料螺丝，尼龙螺丝，塑料铆钉，PCB板隔离柱，配线固定座，电源线扣，六角隔离柱，闭线端子等塑料紧固件。优良的产品，优质的服务，产品畅销全球。

精于专注—传播最具价值的产品和服务，承担风险和社会责任。“卖国内同行的价格，做国外同行的品质，把塑料紧固件行业做专做大，让客户用最好的产品和最有价值的服务”，是传承人一直以来奋斗目标。秉承这一专注的精神坚守，拥有优异产品和周到的服务传承公司，如黑马般在行业同行中迅速崛起。

公司产品款式达100余种，规格1500多个，常备安全库存1500万只。能满足90%以上的客户需求，并能根据客户要求开发模具及定做非标产品。产品符合绿色ROHS认证。支持支付宝交易。基于服务优势公司年销售额以60%的速度增长。目前已成为多家国内外知名企业的长期合作伙伴，秉承“客户第一，合作共赢”的经营理念，致力于打造全球一流的塑料紧固件制造商。愿与您携手共同打造更加优质的产品及服务。

热诚欢迎新老客户莅临指导！

ELEHK (HK) LIMITED is located in Changan Town in Dongguan, It is famous for its manufacturing industry. Since its inception in 2008, The company has been focused on the technology development and supporting applications of plastic fastener products.

Our company's mainly product: Plastic screw cover, plastic anchor, plastic wall plug, cable clip, tilespacers, cable tie, nylon screw, nylon nut, plastic hose clamp, Plastic anchor bolts, Plastic screws, nylon screws, Plastic rivets, PCB spacer support, Cable clamps, strain relief bushing, hexagonal spacer supplier, wire clamp. Such as plastic fasteners. Excellent products, quality services, sold worldwide.

Expertise in Focus—spread the most valuable products and services, Bear risk and social responsibility. "Sell price of domestic counterparts, Do the quality of foreign counterparts, We want to do professional and big in this industry, Make customers get the best products and the most valuable service," that is the goal our company.

Dongguan Chuancheng adhering to focus on the spirit with excellent products and good services, Rise as quickly as the dark horse in the industry. And become one of the more professional supplier of plastic fasteners in Pearl, the company's products more than 70 kinds of styles, more than 500 specifications, standing safety stock 15 million. Satisfy the needs of more than 90% of the customers, And according to customer requirements to open mold and custom non-standard products. Satisfy ROHS certification. Support Alipay, Based on service advantages of 60% annual sales growth rate. Has become a long-term partner of many wellknown enterprises in domestic and abroad.

Adhering to the "customer first, win-win cooperation," business philosophy, To be the world's leading supplier of plastic fasteners.

Willing to work together with you to create more high-quality products and services, Sincerely welcome new and old customers to come and guide us.

## 企业文化 Enterprise culture

企业愿景：让世界更加紧密，创新改变生活。

企业使命：推动行业进步，促进社会发展。

企业经营理念：诚信，创新，合作共赢。

企业精神：团队协作，勇于开拓，共创辉煌。

企业价值观：以卓越品质铸企业之本，以优质服务赢客户之心。

企业服务理念：尊重客户、尊重员工、尊重科学价值。

企业责任：为客户创造价值，为员工搭建成功舞台，为社会做出应有的贡献。

Enterprises are willing: to make the world more closely, innovation and change lives.

Enterprise mission: to promote the progress of the industry and promote social development. Business philosophy: integrity, innovation, win-win cooperation.

Enterprise spirit: teamwork, courage, create brilliant.

Corporate values: excellent quality cast of the enterprise, win the hearts of customers with quality services.

Enterprise service concept: respect, respect for employees, respect for the scientific value.

Corporate responsibility: to create value for customers and employees to build a successful stage, and make due contributions to the society.

精密塑胶 传承优品



荣誉客户 COOPERATIVE PARTNER

卫浴厨房类



电子电器类



五金塑胶类



其它类



公司全景

The company a panoramic



大门



办公室



生产部



技术部



成品仓



料仓



# 相关证书 Relevant certificate

东莞市传承塑胶电子有限公司具有雄厚的技术力量及先进的检测设备,拥有一批专门从事产品开发研制的工程技术人员和精工制造的生产队伍,严格的质量管理体系,为客户提供高品质的产品!

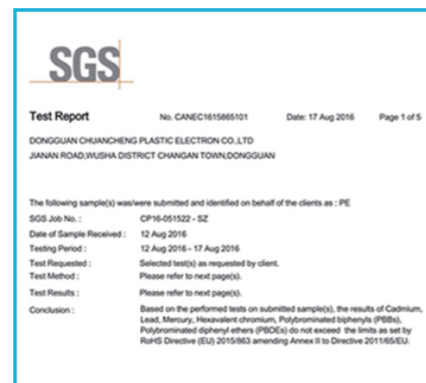

## 我们的优势 We have the advantage of

- 10年专业塑料紧固件制造, 品质保证
- 源头厂家, 只为您提供更优惠的价格
- 规格齐全, 库存充足, 更快的交货期
- 完善的销售服务体系, 让您全程无忧

## 三大环节八大金牌服务



### 售前

- 专人对客户的要求进行数据分析, 充分了解客户需求
- 针对性推荐最合适的产品给每一位客户
- 敬业的专职技术客服, 耐心解答客户咨询



### 售中

- 专人跟进每一张订单, 提供VI P级别服务
- 常规化实时生产玩场产品巡检制度
- 强大的物流支持, 高效、快捷、省心



### 售后

- 对每位客户的需求进行数据备份
- 通过客服回访的方式, 不断升级产品及服务, 帮助客户解决问题

塑料膨胀管 Plastic expansion tubes



● 8-20

螺丝保护帽 Screw cover



● 21-23

瓷砖十字架/钢钉线卡/喉箍



● 24

配线器材 Wiring equipment



● 25-66

CN5042 打结型 Knot expansion pipe with cap



Model 型号	Dia ((MM) 直径	length (MM) 长度	Drill dia 钻头直径	Hole drill 钻孔深度	Screw dia 螺丝尺寸	Material 材质	Qty/bag 数量 /包
CN5042	5	31	5	40	3.8-4.2	PE	2000
	6	36	6	40	3.8-4.2	PE/PA	2000
	7	36	7	40	3.8-4.2	PE	2000
	6	50	6	60	3.8-4.2	PE/PA	2000
	8	50	8	60	4.5-5.5	PE/PA	1000
	10	60	10	70	6-7	PE/PA	500
	12	71	12	80	8.5-9.5	PE/PA	300
	14	75	14	85	10-11.5	PE/PA	200

CN5043 无帽打结型 Knot expansion pipe without cap

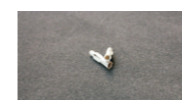

Model 型号	Dia ((MM) 直径	length (MM) 长度	Drill dia 钻头直径	Hole drill 钻孔深度	Screw dia 螺丝尺寸	Material 材质	Qty/bag 数量 /包
CN5043	5	30	6	45	3.8-4.2	PE	2000
	6	36	6	45	3.8-4.2	PE/PA	2000
	7	35	7	45	3.8-4.2	PE	2000
	8	50	8	60	4.5-5.5	PE/PA	1000
	10	60	10	70	6-7	PE/PA	500

CN5055鱼形 Fishy wall plug

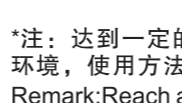

Model 型号	Dia ((MM) 直径	length (MM) 长度	Drill dia 钻头直径	Hole drill 钻孔深度	Screw dia 螺丝尺寸	Material 材质	Qty/bag 数量 /包
CN5055	4	20	4	25	2-2.6	PE/PA	2000
	5	25	5	30	2.8-3.2	PE/PA	2000
	6	30	6	40	3.5-4.5	PE/PA	2000
	7	30	7	40	4.5-5.5	PE/PA	2000
	8	40	8	50	5-6	PE/PA	1000
	10	50	10	60	6.5-7.5	PE/PA	500
	12	60	12	70	8-9.5	PE/PA	*
	14	75	14	85	10-11.5	PE/PA	*

\*注: 达到一定的数量产品颜色可调。因产品所用环境和使用方法的差异, 具体参数以实样测试为准。具体每种产品的适用环境, 使用方法和具体包装方式。请咨询我司销售人员。谢谢!

Remark: Reach a certain number of colors adjustable. The difference in the environment and the use of products, specific parameters subject to testing, Specific for each product applies to the environment, Use-method. Please consult our sales, thank you!



**CN5058 无帽鱼形 Fishy wall plug without cap**

Model 型号	Dia ((MM) 直径	length (MM) 长度	Drill dia 钻头直径	Hole drill 钻孔深度	Screw dia 螺丝尺寸	Material 材质	Qty/bag 数量 /包
CN5058	4	20	4	25	2-2.6	PE/PA	2000
	5	23	5	30	2.8-3.2	PE/PA	2000
	5	25	5	30	2.8-3.2	PE/PA	2000
	6	25	6	30	3.5-4.2	PE/PA	2000
	6	27	6	38	3.5-4.2	PE/PA	2000
	6	30	6	40	3.5-4.2	PE/PA	2000
	7	30	7	40	4.5-5	PE/PA	2000
	7	33	7	40	4.5-5	PE/PA	2000
	7	35	7	45	4.5-5	PE/PA	2000
	8	37	8	45	5-5.5	PE/PA	1000
	8	40	8	50	5-5.5	PE/PA	1000
	10	37	10	45	6-7	PE/PA	1000
	10	43	10	50	6-7	PE/PA	1000
	10	50	10	60	6-7	PE/PA	500
	10	60	10	70	6-7	PE/PA	500
12	60	12	70	8-9.5	PE/PA	*	
12	73	12	80	8-9.5	PE/PA	*	
14	75	14	85	10-11.5	PE/PA	*	

**CN5018 锯齿型 Hollow brick anchor**

Model 型号	Dia ((MM) 直径	length (MM) 长度	Drill dia 钻头直径	Hole drill 钻孔深度	Screw dia 螺丝尺寸	Material 材质	Qty/bag 数量 /包
CN5018	5	25	5	35	2.8-3.2	PE	2000
	6	40	6	50	3.5-4	PE	2000
	8	50	8	60	5-5.5	PE	1000
	10	65	10	75	6-7	PE	500

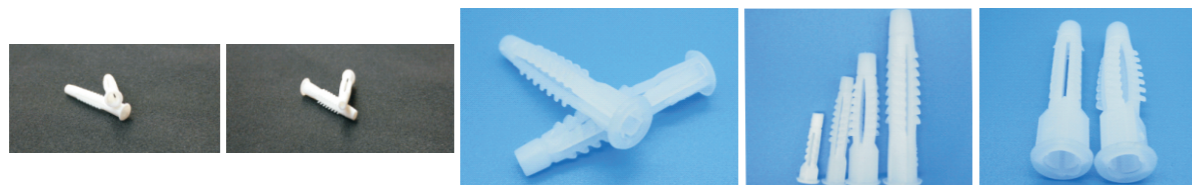

\*注: 达到一定的数量产品颜色可调。因产品所用环境和使用方法的差异, 具体参数以实样测试为准。具体每种产品的适用环境, 使用方法和具体包装方式。请咨询我司销售人员。谢谢!

Remark: Reach a certain number of colors adjustable. The difference in the environment and the use of products, specific parameters subject to testing, Specific for each product applies to the environment, Use-method. Please consult our sales, thank you!

**CN5065 加强型 Nylon expansion pipe**

Model 型号	Dia ((MM) 直径	length (MM) 长度	Drill dia 钻头直径	Hole drill 钻孔深度	Screw dia 螺丝尺寸	Material 材质	Qty/bag 数量 /包
CN5065	6	30	6	35	3.5-4	PA	2000
	8	40	8	40	5-5.5	PA	2000
	10	50	10	60	6-7.2	PA	1000
	12	60	12	70	9-10	PA	500

**CN5085 中空型 Nylon hollow expansion pipe**

Model 型号	Dia ((MM) 直径	length (MM) 长度	Drill dia 钻头直径	Hole drill 钻孔深度	Screw dia 螺丝尺寸	Material 材质	Qty/bag 数量 /包
CN5085	6	35	6	40	3-3.8	PA	2000
	8	50	8	60	4.5-5	PA	1000
	10	60	10	70	6-6.8	PA	500

**CN5086 无帽中空型 No cap hollow anchor**

Model 型号	Dia ((MM) 直径	length (MM) 长度	Drill dia 钻头直径	Hole drill 钻孔深度	Screw dia 螺丝尺寸	Material 材质	Qty/bag 数量 /包
CN5086	8	50	8	60	4.5-5	PA	1000

**CN6091 飞机型 Butterfly Toggle Anchors**

Model 型号	Dia ((MM) 直径	length (MM) 长度	Drill dia 钻头直径	Hole drill 钻孔深度	Screw dia 螺丝尺寸	Material 材质	Qty/bag 数量 /包
CN6091	10	28	10	35	3.5-4	PA	500
	10	36	10	40	3.5-4	PA	500
	10	45	10	50	3.5-4.2	PA	300

**CN6118 兰花夹 Orchid clamp**

Model 型号	Dia ((MM) 直径	length (MM) 长度	Drill dia 钻头直径	Hole drill 钻孔深度	Screw dia 螺丝尺寸	Material 材质	Qty/bag 数量 /包
CN6118	8	25	8	30	2.5-3	PP	1000
	8	34	8	40	2.5-3	PP	1000
	8	38	8	45	2.5-3.2	PP	1000
	9	18	8	25	3-3.8	PP	1000

**CN5071 六翅型 Six-wing expansion pipe**

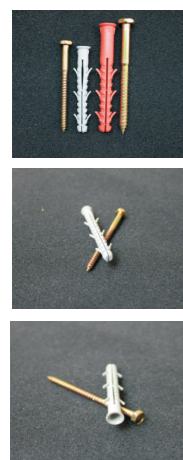

Model 型号	Dia ((MM) 直径	length (MM) 长度	Drill dia 钻头直径	Hole drill 钻孔深度	Screw dia 螺丝尺寸	Material 材质	Qty/bag 数量 /包
CN5071	8	80	8	90	2-2.6	PA	*
	8	100	8	110	2.8-3.2	PA	*
	8	120	8	130	2.8-3.2	PA	*
	10	100	10	110	3.5-4.2	PA	*
	10	115	10	130	3.5-4.2	PA	*
	10	135	10	150	3.5-4.2	PA	*
	10	160	10	160	4.5-5	PA	*
	10	200	10	200	4.5-5	PA	*

**CN5059 双翅型 Two-wing expansion pipe**



Model 型号	Dia ((MM) 直径	length (MM) 长度	Drill dia 钻头直径	Hole drill 钻孔深度	Screw dia 螺丝尺寸	Material 材质	Qty/bag 数量 /包
CN5059	6	35	6	45	3.5-4	PA	*
	6	40	6	50	3.5-4	PA	*
	6	50	6	60	3.5-4	PA	*
	6	60	6	70	3.5-4	PA	*
	6	80	6	90	3.5-4	PA	*
	8	40	8	50	5-5.5	PA	*
	8	50	8	60	5-5.5	PA	*
	8	60	8	70	5-5.5	PA	*
	8	80	8	90	5-5.5	PA	*
	8	100	8	110	5-5.5	PA	*
	8	120	8	130	5-5.5	PA	*
	8	135	8	145	5-5.5	PA	*
	10	60	10	70	6-7	PA	*
	10	80	10	90	6-7	PA	*
	10	100	10	110	6-7	PA	*
	10	115	10	125	6-7	PA	*
	10	135	10	150	6-7	PA	*
	10	160	10	170	6-7	PA	*

**CN6105 沉头打入型 Countersunk nylon anchor**



Model 型号	Dia ((MM) 直径	length (MM) 长度	Drill dia 钻头直径	Hole drill 钻孔深度	Screw dia 螺丝尺寸	Material 材质	Qty/bag 数量 /包
CN6105	5	30	5	40	2.8-3.2	PA	*
	5	35	5	45	2.8-3.2	PA	*
	5	40	5	50	2.8-3.2	PA	*
	5	50	5	60	2.8-3.2	PA	*
	6	30	6	40	3.5-4	PA	*
	6	40	6	50	3.5-4	PA	*
	6	50	6	60	3.5-4	PA	*
	6	60	6	70	3.5-4	PA	*
	6	70	6	80	3.5-4	PA	*
	6	80	6	90	3.5-4	PA	*
	8	45	8	55	5-5.5	PA	*
	8	60	8	70	5-5.5	PA	*
	8	80	8	90	5-5.5	PA	*
	8	100	8	110	5-5.5	PA	*
	8	120	8	130	5-5.5	PA	*
	8	135	8	145	5-5.5	PA	*
	8	160	8	170	5-5.5	PA	*
	10	80	10	90	6-7	PA	*
	10	100	10	110	6-7	PA	*
	10	120	10	130	6-7	PA	*
10	135	10	145	6-7	PA	*	
10	160	10	170	6-7	PA	*	

**CN6020 锥型 Pagoda expansion pipes**



Model 型号	Dia ((MM) 直径	length (MM) 长度	Drill dia 钻头直径	Hole drill 钻孔深度	Screw dia 螺丝尺寸	Material 材质	Qty/bag 数量 /包
CN6020	5	20	5	25	2.8-3	PE	2000
	6	21	6	30	3.5-4	PE	2000
	6	22	6	30	3.5-4	PE	2000
	8	25	8	35	4.2-5	PE	2000
	10	36	10	45	5-6	PE	1000



**CN5027 圆头打入型 Round head nylon anchor**



Model 型号	Dia ((MM) 直径	length (MM) 长度	Drill dia 钻头直径	Hole drill 钻孔深度	Screw dia 螺丝尺寸	Material 材质	Qty/bag 数量/包
CN5027	5	30	5	40	2.8-3.2	PA	*
	5	35	5	45	2.8-3.2	PA	*
	5	40	5	50	2.8-3.2	PA	*
	5	50	5	60	2.8-3.2	PA	*
	6	30	6	40	3.5-4	PA	*
	6	40	6	50	3.5-4	PA	*
	6	50	6	60	3.5-4	PA	*
	6	60	6	70	3.5-4	PA	*
	6	70	6	80	3.5-4	PA	*
	6	80	6	90	3.5-4	PA	*
	8	45	8	55	5-5.5	PA	*
	8	60	8	70	5-5.5	PA	*
	8	80	8	90	5-5.5	PA	*
	8	100	8	110	5-5.5	PA	*
	8	120	8	130	5-5.5	PA	*
	8	135	8	145	5-5.5	PA	*
	8	160	8	170	5-5.5	PA	*

**CN6010 窗格型 Windows expansion pipe**



Model 型号	Dia ((MM) 直径	length (MM) 长度	Drill dia 钻头直径	Hole drill 钻孔深度	Screw dia 螺丝尺寸	Material 材质	Qty/bag 数量/包
CN6010	8	75	5	85	5-5.5	PA	*
	8	100	5	110	5-5.5	PA	*
	8	120	5	130	5-5.5	PA	*
	8	140	6	150	5-5.5	PA	*
	10	75	6	85	6-7.2	PA	*
	10	100	6	110	6-7.2	PA	*
	10	120	6	130	6-7.2	PA	*
	10	140	6	150	6-7.2	PA	*
	10	165	6	170	6-7.2	PA	*

**CN5091 石膏型 Plasterboard expansion PiPe 适用于：石膏墙，石膏板，轻质板等环境**

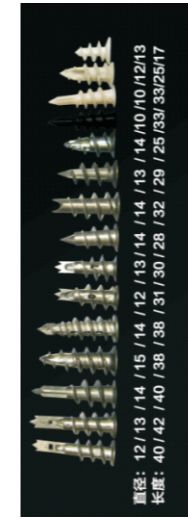

Model 型号	Dia ((MM) 直径	length (MM) 长度	Drill dia 钻头直径	Hole drill 钻孔深度	Screw dia 螺丝尺寸	Material 材质	Qty/bag 数量/包
CN5091	14	55	6	10-15MM	2-2.8	PA (尼龙)	1000
	15	45	6	10*15MM	3.5-4	PA (尼龙)	1000
	14	45	6	10-15MM	3.5-4	PA (尼龙)	1000
	13	42	6	10*15MM	3.5-4	PA/POM	1000
	13	40	6	10-15MM	3.5-4	PA (尼龙)	1000
	15	28	6	10*15MM	3-3.5	PA (尼龙)	2000
	14	29	6	10-15MM	3-3.5	PA (尼龙)	2000
	12	34	6	10*15MM	3-3.5	PA (尼龙)	2000
	15	33	6	10-15MM	3.5-4	PA (尼龙)	1000
	10	33	6	10*15MM	3-3.5	PA/POM	2000
	12	40			3.5-4	Zinc	500
	13	42			3.5-4	Zinc	500
	14	40			3.5-4	Zinc	500
	15	38			3.5-4	Zinc	500
	14	38			3.5-4	Zinc	500
	12	31			3-3.5	Zinc	500
	13	30			3-3.5	Zinc	500
	14	28			3-3.5	Zinc	500
	14	32			3-3.5	Zinc	500
	13	29			3-3.5	Zinc	500
	14	25			3-3.5	Zinc	500
	10	33	6	10-15MM	3-3.5	PA/POM	2000
	12	25	6	10-15MM	3-3.5	PA (尼龙)	2000
	13	17	6	10*15MM	2-3	PA (尼龙)	3000

**CN5069 直通型 common wall plug**

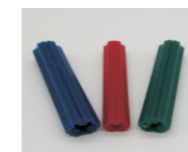
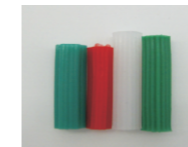
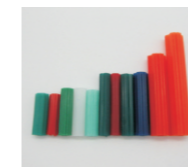

Model 型号	Dia ((MM) 直径	length (MM) 长度	Drill dia 钻头直径	Hole drill 钻孔深度	Screw dia 螺丝尺寸	Material 材质	Qty/bag 数量/包
CN5069	5	25	5	28	2.8-3	PE	2000
	6	25	6	28	3.5-4	PE	2000
	6	30	6	35	3.5-4	PE	2000
	7	38	7	42	3.5-4	PE	2000
	7	50	7	55	3.5-4	PE	1000
	8	25	8	28	4.5-5.5	PE	2000
	8	38	8	42	4.5-5.5	PE	2000
	8	50	8	55	4.5-5.5	PE	1000
	10	38	10	42	5.5-7	PE	1000
	10	50	10	55	5.5-7	PE	500
	10	60	10	65	5.5-7	PE	500
	12	60	12	65	7-9.5	PE	*
	12	75	12	80	7-9.5	PE	*



**CN5068 尖尾直通型 common wall plug**

Model 型号	Dia ((MM) 直径	length (MM) 长度	Drill dia 钻头直径	Hole drill 钻孔深度	Screw dia 螺丝尺寸	Material 材质	Qty/bag 数量 /包
CN5068	6	27	6	35	3.5-4	PE	2000
	7	28	7	35	4-4.5	PE	2000
	8	31	8	35	4-4.5	PE	2000

**CN5015 英规型 British expansion pipe**

Model 型号	Dia ((MM) 直径	length (MM) 长度	Drill dia 钻头直径	Hole drill 钻孔深度	Screw dia 螺丝尺寸	Material 材质	Qty/bag 数量 /包
CN5015	5	25	5	30	2.8-3	PE	*
	6	30	6	35	3.5-4	PE	*
	7	38	7	45	3.5-4	PE	*
	10	45	10	55	5-6.2	PE	*

**CN5081 美规型 American expansion pipe**

Model 型号	Dia ((MM) 直径	length (MM) 长度	Drill dia 钻头直径	Hole drill 钻孔深度	Screw dia 螺丝尺寸	Material 材质	Qty/bag 数量 /包
CN5081	5	22	5	30	2.8-3	PE	1000
	6	25	6	30	3.2-3.5	PE	1000
	7	30	7	35	3.5-4	PE	1000
	8	38	8	45	4.5-5	PE	1000

**CN5031 无帽塔型 Tower anchor without cap**

Model 型号	Dia ((MM) 直径	length (MM) 长度	Drill dia 钻头直径	Hole drill 钻孔深度	Screw dia 螺丝尺寸	Material 材质	Qty/bag 数量 /包
CN5031	5	25	5	30	2.8-3	PE	2000
	6	25	6	30	3.2-3.5	PE	2000
	6	30	6	35	3.2-3.5	PE	2000
	8	30	8	35	3.5-4	PE	2000
	8	35	8	40	3.5-4	PE	2000
	10	38	10	45	4.5-5	PE	2000

**CN5030 塔型 Tower anchor with cap**

Model 型号	Dia ((MM) 直径	length (MM) 长度	Drill dia 钻头直径	Hole drill 钻孔深度	Screw dia 螺丝尺寸	Material 材质	Qty/bag 数量 /包
CN5030	5	22	5	30	2.8-3	PE	2000
	6	25	6	30	3.2-3.5	PE	2000
	8	30	8	35	3.5-4	PE	2000

**CN5057 澳规蘑菇型 Mushroom head anchor**

Model 型号	Dia ((MM) 直径	length (MM) 长度	Drill dia 钻头直径	Hole drill 钻孔深度	Screw dia 螺丝尺寸	Material 材质	Qty/bag 数量 /包
CN5057	5	25	5	40	2.8-3.2	PA	2000
	5	38	5	50	2.8-3.2	PA	2000
	6	25	5	60	2.8-3.2	PA	2000
	6	38	6	40	3.2-3.8	PA	1000
	6	50	6	50	3.2-3.8	PA	500
	6	75	6	60	3.2-3.8	PA	500

**CN5054 澳规圆头型 Round head anchor**

Model 型号	Dia ((MM) 直径	length (MM) 长度	Drill dia 钻头直径	Hole drill 钻孔深度	Screw dia 螺丝尺寸	Material 材质	Qty/bag 数量 /包
CN5054	5	25	5	40	2.8-3.2	PA	2000
	5	38	5	50	2.8-3.2	PA	2000
	6	25	5	60	2.8-3.2	PA	2000
	6	38	6	40	3.2-3.8	PA	1000
	6	50	6	50	3.2-3.8	PA	500
	6	75	6	60	3.2-3.8	PA	500

**CN5053 澳规沉头型 Countersunk head white anchor**

Model 型号	Dia ((MM) 直径	length (MM) 长度	Drill dia 钻头直径	Hole drill 钻孔深度	Screw dia 螺丝尺寸	Material 材质	Qty/bag 数量 /包
CN5053	5	25	5	40	2.8-3.2	PA	2000
	5	38	5	50	2.8-3.2	PA	2000
	6	25	5	60	2.8-3.2	PA	2000
	6	38	6	40	3.2-3.8	PA	1000
	6	50	6	50	3.2-3.8	PA	500
	6	75	6	60	3.2-3.8	PA	500

**CN1360 台阶型 Steps anchor**

Model 型号	Dia ((MM) 直径	length (MM) 长度	Drill dia 钻头直径	Hole drill 钻孔深度	Screw dia 螺丝尺寸	Material 材质	Qty/bag 数量/包
CN1360	6	25	6	30	2.8-3	PE	2000

**CN1358 对排型 Steps anchor**

Model 型号	Dia ((MM) 直径	length (MM) 长度	Drill dia 钻头直径	Hole drill 钻孔深度	Screw dia 螺丝尺寸	Material 材质	Qty/bag 数量/包
CN1358	6	28	6	30	2.8-3	PE	2000

**CN1330 三边型 Three sides anchor**

Model 型号	Dia ((MM) 直径	length (MM) 长度	Drill dia 钻头直径	Hole drill 钻孔深度	Screw dia 螺丝尺寸	Material 材质	Qty/bag 数量/包
CN1330	7	22	5	40	2.8-3.2	PE	2000
	8	25	5	50	2.8-3.2	PE	2000
	9	28	5	60	2.8-3.2	PE	2000
	10	33	6	40	3.5-4	PE	2000

**CN6092 机翼型 Ceiling anchor**

Model 型号	Dia ((MM) 直径	length (MM) 长度	Drill dia 钻头直径	Hole drill 钻孔深度	Screw dia 螺丝尺寸	Material 材质	Qty/bag 数量/包
CN6092	10	34	10	40	3-3.5	PE	*

**CN5066 菱型 Plasterboard anchor**

Model 型号	Dia ((MM) 直径	length (MM) 长度	Drill dia 钻头直径	Hole drill 钻孔深度	Screw dia 螺丝尺寸	Material 材质	Qty/bag 数量/包
CN5066	11	25	8	60	2.8-3.2	PE	*

**CN5067 机尾型 Plasterboard anchor**

Model 型号	Dia ((MM) 直径	length (MM) 长度	Drill dia 钻头直径	Hole drill 钻孔深度	Screw dia 螺丝尺寸	Material 材质	Qty/bag 数量/包
CN5067	8	32	8	35	2.8-3.2	PE	

**CN7012 卫浴马桶套装 Bathroom kits anchor**

Model 型号	Dia ((MM) 直径	长度length (MM)	钻头直径 Drill dia (MM)	Hole drill (MM) 钻孔深度	Screw dia (MM) 螺丝直径	Material 材料
CN7012	10	50	10	60	5.5-7	PA
	12	60	12	70	6.5-9	
	14	75	14	90	8.5-11	

**CN6107 蘑菇头打入型 Countersunk head anchor**

Model 型号	Dia ((MM) 直径	length (MM)长度	Drill dia 钻头直径	Hole drill 钻孔深度	Screw dia 螺丝尺寸	Material 材质	Qty/bag 数量/包
CN6107	6	40	6	50	3.5-4	PA	*
	6	60	6	70	3.5-4	PA	*
	6	80	6	90	3.5-4	PA	*

**CN6106 沉头曲身打入型 Countersunk head anchor**

Model 型号	Dia ((MM) 直径	length (MM)长度	Drill dia 钻头直径	Hole drill 钻孔深度	Screw dia 螺丝尺寸	Material 材质	Qty/bag 数量/包
CN6106	5	30	5	40	2.8-3.2	PA	*
	6	40	6	50	3.5-4	PA	*
	6	60	6	70	3.5-4	PA	*
	6	80	6	90	3.5-4	PA	*
	8	80	8	90	5-5.5	PA	*
	8	100	8	110	5-5.5	PA	*
	8	120	8	130	5-5.5	PA	*

**CN5045 六边打结型 Six Knot exPansion PiPe with caP**

Model 型号	Dia ((MM) 直径	length (MM) 长度	Drill dia 钻头直径	Hole drill 钻孔深度	Screw dia 螺丝尺寸	Material 材质	Qty/bag 数量/包
CN5045	8	40	8	50	5-5.5	PA	1000



**CN1362 保固型 Ruggedized Plastic anchor**

Model 型号	Dia (MM) 直径	length (MM) 长度	Drill dia 钻头直径	Hole drill 钻 孔深度	Screw dia 螺丝尺寸	Material 材质	Qty/bag 数量/包
CN1362	6	25	6	30	2.5-3	PE	2000
	8	30	8	35	2.5-3	PE	2000

**CN5019 拧结式 Twisters Plastic bolt**

Model 型号	Dia (MM) 直径	length (MM) 长度	Drill dia 钻头直径	Hole drill 钻 孔深度	Screw dia 螺丝尺寸	Material 材质	Qty/bag 数量/包
CN5019	10	60	10	70	6-7.2	PE/PA	500
	11	50	10	60	6-7.2	PE	500

**CN5034 四角齿形 Four Corners tooth anchor**

Model 型号	Dia (MM) 直径	length (MM) 长度	Drill dia 钻头直径	Hole drill 钻 孔深度	Screw dia 螺丝尺寸	Material 材质	Qty/bag 数量/包
CN5034	6	30	6	35	3.5-4.2	PE	2000
	8	36	8	40	4.5-5	PE	1000
	10	44	10	50	5-6.2	PE	1000

**CN5056 六角鱼形 Six ridge fisher anchor bolt**

Model 型号	Dia (MM) 直径	length (MM) 长度	Drill dia 钻头直径	Hole drill 钻 孔深度	Screw dia 螺丝尺寸	Material 材质	Qty/bag 数量/包
CN5056	6	28	6	35	3.5-4.2	PE	2000
	8	38	8	45	4.5-5	PE	1000
	10	36	10	45	5.5-6.5	PE	1000

**CN5082 双边塔形 Double\_sided Tower anchor**

Model 型号	Dia (MM) 直径	length (MM) 长度	Drill dia 钻头直径	Hole drill 钻 孔深度	Screw dia 螺丝尺寸	Material 材质	Qty/bag 数量/包
CN5082	6	25	6	30	3-3.8	PE	2000
	8	36	8	40	4.5-5	PE	1000

**CN5083 鱼刺形 Fishbone plastic anchor bolt**

Model 型号	Dia (MM) 直径	length (MM) 长度	Drill dia 钻头直径	Hole drill 钻 孔深度	Screw dia 螺丝尺寸	Material 材质	Qty/bag 数量/包
CN5083	8	35	8	40	4.5-5	PE	1000

**CN1361 刺型 Spine anchor**

Model 型号	Dia (MM) 直径	length (MM) 长度	Drill dia 钻头直径	Hole drill 钻 孔深度	Screw dia 螺丝尺寸	Material 材质	Qty/bag 数量/包
CN1361	6	25	6	30	2.5-3	PE	2000

**CN5020 小黄鱼 Small yellow croaker**

Model 型号	Dia (MM) 直径	length (MM) 长度	Drill dia 钻头直径	Hole drill 钻 孔深度	Screw dia 螺丝尺寸	Material 材质	Qty/bag 数量/包
CN5020	6	30	6	40	3.5-4	PE	1000
	6	40	6	50	3.5-4	PE	1000
	6	60	6	70	3.5-4	PE	1000
	6	80	6	90	3.5-4	PE	1000
	6	100	6	110	3.5-4	PE	1000
	8	40	8	50	5-5.5	PE	1000
	8	60	8	70	5-5.5	PE	1000
	8	80	8	90	5-5.5	PE	1000
	8	100	8	110	5-5.5	PE	1000
	8	120	8	130	5-5.5	PE	1000
	8	135	8	145	5-5.5	PE	1000
	8	150	8	160	5-5.5	PE	1000
	10	50	10	60	6-7	PE	1000
	10	60	10	70	6-7	PE	1000
	10	80	10	90	6-7	PE	1000
	10	100	10	110	6-7	PE	1000
	10	120	10	130	6-7	PE	1000
	10	135	10	145	6-7	PE	1000
	10	160	10	170	6-7	PE	1000
	10	200	10	210	6-7	PE	1000

**塑料预埋膨胀塞 Plastic embedded expansion**



Model 型号	HS0805A
主要材质 Material	塑料 Plastic
表面处理 Finish	白色、黑色、灰色、棕色 White.Black.Grey.Brown

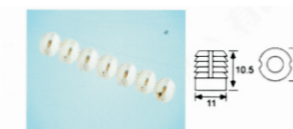

Model 型号	HS0805B
主要材质 Material	塑料 Plastic
表面处理 Finish	白色、黑色、灰色、棕色 White.Black.Grey.Brown

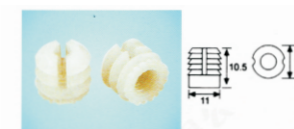

Model 型号	HS0806
主要材质 Material	塑料 Plastic
表面处理 Finish	白色、黑色、棕色 White.Black.Brown



Model 型号	HS0808
主要材质 Material	塑料 Plastic
表面处理 Finish	白色、黑色、棕色 White.Black.Brown

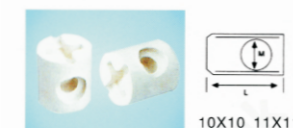

Model 型号	HS0809
主要材质 Material	塑料 Plastic
表面处理 Finish	白色、黑色、灰色、棕色 White.Black.Grey.Brown

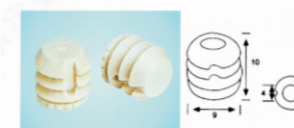

Model 型号	HS08010
主要材质 Material	塑料 Plastic
表面处理 Finish	白色、黑色 White.Black



**CN106 平头六角螺丝保护帽**  
Flat Head plastic screw cover

Model 型号	Size (MM) 尺寸	内对边 (MM)	外对边 (MM)	总高度 (MM)
CN106	M6	10	13	5
	M6	10	13	8.5
	M8	13	16	10
	M8	14	17	7
	M10	16	19	10
	M10	17	21	20.5
	M12	18	21	10.5
	M12	19	22	20.5
	M14	21	24	20.5
	M16	21	24	20.5
	M16	24	27	20.5
	M18	27	30	20.5
	M20	30	33	30
	M30	45	49	67
	M33	50	55	67
	M36	54	60	67
	M39	60	65	67
	M42	65	68	80
	M45	70	84	80
	M48	75	78	85
M52	80	85	85	
M56	85	80	82	
M60	90	83	85	
M64	95	83	90	

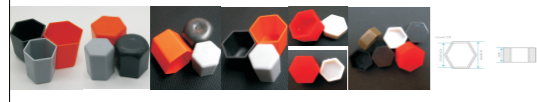

**CN107 外圆内六角螺丝保护帽**  
External Hexagon screw cover

Model 型号	Size (MM) 尺寸	内对边 (MM)	直边高度 (MM)	总高度 (MM)	外直径 (MM)
CN107	M4	7	4.5	8.5	9
	M5	8	5.5	9.5	11
	M6	10	8.5	14	14
	M8	12	8	13.5	15
	M8	13	9.5	16	17.5
	M8	14	8.5	15.5	18
	M10	16	10.5	20	21.5
	M10	17	10.5	20	21
	M12	18	11	20	24
	M12	19	12	21.5	24
	M14	22	14.5	26	27.5
	M16	24	16.5	29	30.5
	M18	26	15.5	28	32.5
	M20	30	19.5	35	36
	M22	32	19.5	38	39.5
	M24	36	20.5	42	44
	M27	41	32	56	49
	M30	45	37	62	55
	M33	50	35	53	60
	M36	54	35	65	64
M36	54	55	65	67	
M42	65	40	83	67	
M45	70	55	85	85	
M48	75	40	85	90	



**CN108 加高形内外六角螺丝保护帽**  
Lengthened crew cover

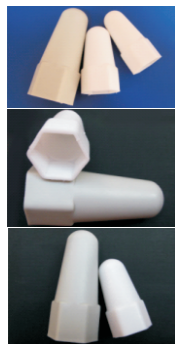

Model 型号	Size (MM) 尺寸	内对边 (MM)	外对边 (MM)	总高度 (MM)
CN108	M8	13	15	25
	M10	17	20	34
	M12	18	23	37
	M12	19	23	37
	M14	22	26	48
	M16	24	27	36
	M16	22	26	52
	M18	28	31	47
	M18	27	30	60
	M20	31	34	45
	M20	30	33	70
	M24	35	39	48
	M24	36	40	100
	M27	41	45	80
	M30	45	49	75
M30	46	51	110	



**CN108 内外六角螺丝保护帽**  
Hexagon screw cover

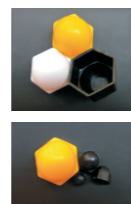

Model 型号	Size (MM) 尺寸	内对边 (MM)	外对边 (MM)	总高度 (MM)
CN108	M4	7	9	4.5
	M5	8	9.5	11
	M6	10	12	13
	M8	13	15	15
	M10	17	19	21
	M12	19	22	22
	M14	21	23	27
	M14	22	24	27
	M16	24	27	29
	M18	27	29	29
	M20	30	33	37
	M22	32	36	37
	M24	36	39	41
	M27	41	44	47
	M30	46	50	53
	M32	50	54	65
	M33	50	53	57
	M36	56	60	65
	M39	60	65	73
	M42	65	70	78
M49	80	100	87	

**CN126 圆管/牙杆/型材保护帽** Plastic cover

Model 型号	直径 (MM)	长度 (MM)	厚度 (MM)	可生产此范围内的任意尺寸
CN126	≤180	1.4 - 267	0.2 - 15	

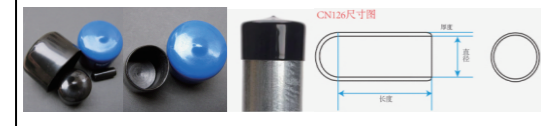

**CN109 内外圆螺丝保护帽**  
Inner circle screw cover for Round screw

Model 型号	Size (MM) 尺寸	内径 (MM)	外直径 (MM)	总高度 (MM)
CN109	M8	13	16	18
	M10	16	19	20
	M12	18	21	25
	M14	21	24	27
	M16	24	27	30
	M18	27	30	35
	M20	30	33	37
	M24	36	39	44
	M30	45	48	54
	M36	50	53	65



**CN111 盖形内外圆螺丝保护帽** Round-shaped screw cover

Model 型号	Size (MM) 尺寸	内径 (MM)	直边高度 (MM)	总高度 (MM)	外直径 (MM)
CN111	M5	4.2	2.8	4.5	8
	M6	5	2.3	3.3	9.45
	M8	6.2	2.8	4.8	11.6
	M10	8.3	2.9	5	14.05
	M12	10.2	3	5	16.9
	M14	12	7	9	19
	M16	12.4	3.9	5.7	20.9
	M20	14.4	4.4	6.4	26.8
	M24	19.3	4.9	7	31.8



**CN112 螺丝保护帽** Plastic screw cover

Model 型号	Size (MM) 尺寸	直径 (MM)	对边 (MM)	总高度 (MM)
CN112	M8	25	13	16



**CN114 螺丝保护帽** Plastic screw cover

Model 型号	Size (MM) 尺寸	内直径 (MM)	内对边 (MM)	直边高度 (MM)	总高度 (MM)
CN114	M12	39	19	14	30
	M16	33	24	17	36
	M20	40	30	23	46

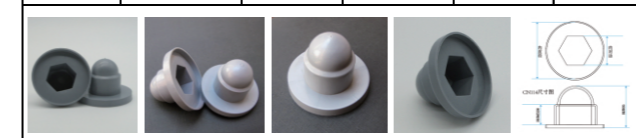

**CN115 螺丝保护帽** Plastic screw cover

Model 型号	Size (MM) 尺寸	内对边 (MM)	外径尺寸 (MM)	总高度 (MM)
CN115	M8	13	25	13



**CN116 螺丝保护帽** Plastic screw cover

Model 型号	外径 (MM)	内径 (MM)	对边 (MM)	总高度 (MM)
CN116	19	16	8	7

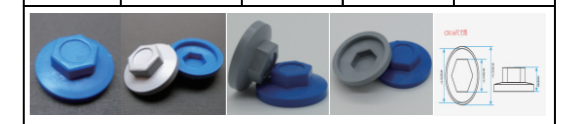

**CN117 螺丝保护帽** Plastic screw cover

Model 型号	A	B	C	D	E	F	材质
CN117	3.65	13.1	9.87	3.8	3	4.3	PE/PA
	3.7	13.2	9.8	5	3	4.4	PE/PA
	2.6	14	10.6	5.4	2.7	3.7	PE/PA

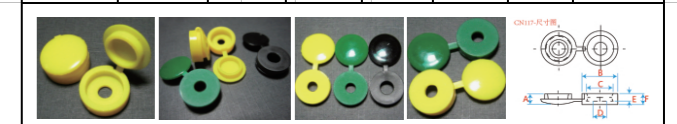

**CN119 螺丝保护帽** Plastic screw cover

Model 型号	Size (MM) 尺寸	内直径 (MM)	外直径 (MM)	总高度 (MM)	A (MM)
CN119	M6	6.4	10.5	4	7

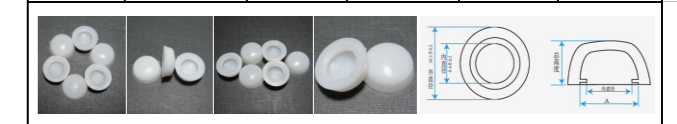

CN120 凸型双螺防锈帽 Convex type twin screw rust cap



Model 型号	Size (MM) 尺寸	内对边 (MM)	总高度 (MM)
CN120	M20	30	100
	M22	32	100
	M24	34	100
	M24	35	100
	M24	36	100
	M27	39	100
	M27	40	100
	M27	41	100
	M27	42	100
	M30	43	100
	M30	44	100
	M30	45	100
	M32	49	100
	M33	50	100
	M36	55	110
	M39	60	115
	M39	60	160
	M42	65	120
	M42	65	160
	M45	70	130
M45	70	160	
M48	75	130	
M48	75	160	
M52	80	160	
M56	85	160	

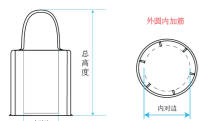

CN130 双螺母保护帽(内加筋/内六边) Double nut protective cap (inside reinforcement/inner 6)

Model 型号	Size (MM) 尺寸	内对边 (MM)	总高度 (MM)
CN130	M14 内加筋	21	85
	M14 内加筋	22	85
	M16 内加筋	23	85
	M16 内加筋	24	85
	M18 内加筋	27	85
	M20 内加筋	30	85
	M22 内加筋	32	85
	M24 内加筋	34	85
	M24 内加筋	35	85
	M24 内加筋	36	85
M24 内六边	36	85	

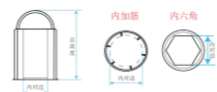

CN131 凸型单螺母保护帽 Convex single-nut protective cover

Model 型号	Size (MM) 尺寸	内对边 (MM)	总高度 (MM)
CN131	M10 内加筋	17	46
	M12 内加筋	18	46
	M12 内加筋	19	46
	M14 内加筋	21	46
	M14 内加筋	22	46
	M16 内加筋	23	46
	M16 内六边	24	46
	M18 内加筋	27	46
	M20 内六边	30	46
	M22 内加筋	32	52
	M24 内六边	36	52

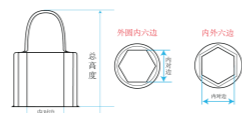

CN125 内六角螺丝保护帽 Plastic screw cover

Model 型号	Size (MM) 尺寸	内对边 (MM)	外径尺寸 (MM)	总高度 (MM)
CN125	M6	11	15	10
	M8	14	18	10
	M10	17	20	12

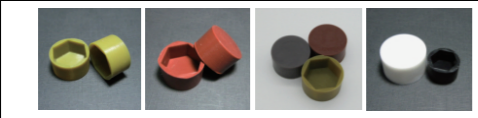

CN126 圆管/牙杆/型材保护帽 Plastic cover

Model 型号	直径 (MM)	长度 (MM)	厚度 (MM)	可生产此范围内的任意尺寸
CN126	≤180	1.4 - 267	0.2 - 15	

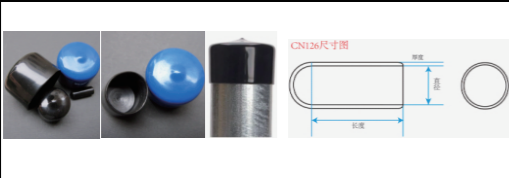

CN132 外圆内12角螺母保护帽 Protective cap of 12 horned nut in outer circle

Model 型号	Size (MM) 尺寸	内对边 (MM)	总高度 (MM)
CN132	M30	45	62
	M33	50	67
	M36	50	65
	M39	60	75
	M42	65	76
	M45	70	80
	M48	75	82

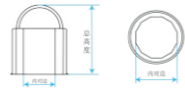

CN133 内外六角螺母保护帽 Inner and outer hexagon nut case

Model 型号	Size (MM) 尺寸	内对边 (MM)	内直径 (MM)	总高度 (MM)
CN133	M24	36	64	55
	M27	41	69	55
	M30	46	73	55

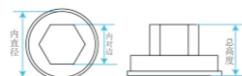
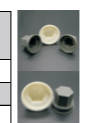

CN1001 瓷砖十字架 Tile spacers



Model 型号	Size (MM) 尺寸	Thickness (MM) 厚度	Wide (MM) 宽度	length (MM) 钉子长度	Material 材料	Color 颜色	Application 使用环境
CN1001	1	3	1	21	PE	White	Seamless brick / Polished 无缝砖/抛光砖
	1.5	3	1.5	21	PE	White	Seamless brick / Polished 无缝砖/抛光砖
	2	3	2	21	PE	White	Tiles / wall 瓷片/墙砖
	2.5	3	2.5	21	PE	White	Tiles / wall 瓷片/墙砖
	3	4	3	22	PE	White	Outdoor brick 户外砖/大尺寸抛砖
	3.5	4	3.5	22	PE	White	Outdoor brick 户外砖/大尺寸抛砖
	4	4	4	22	PE	White	Outdoor brick 户外砖/大尺寸抛砖
	5	5	5	24	PE	White	Antique tiles / marble / outdoor brick 仿古砖/大理石/户外砖
	6	5	6	24	PE	White	Antique tiles / marble 仿古砖/大理石
	8	5	8	26	PE	White	Antique tiles / marble 仿古砖/大理石
	10	5	10	28	PA	White	Antique tiles / marble 仿古砖/大理石

CN2001 钢钉线卡 Cable clip



Model 型号	Size (MM) 尺寸	Shape 形状	Material (MM) 材料	Color 颜色	Qty/bag 数量/包	Line dia (MM) 线直径	weight/bag 重量/包
CN2001	3.5	Round	PE	White	100	3-3.5	0.92
	4	Round/Square	PE	White	100	3.5-4	0.92
	5	Round/Square	PE	White	100	4.5-5	1.04
	6	Round/Square	PE	White	100	5.5-6	1.21
	7	Round/Square	PE	White	100	6.5-7	1.27
	8	Round/Square	PE	White	100	7.5-8	1.44
	9	Round/Square	PE	White	100	8.5-9	1.67
	10	Round/Square	PE	White	100	9.5-10	1.84
	12	Round/Square	PE	White	100	11.1-12	2.42
	14	Round/Square	PE	White	100	13-14	3.39
	16	Round	PE	White	100	15-16	4.14
	18	Round	PE	White	100	17-18	5.29
	20	Round	PE	White	100	19-20	6.73
	22	Round	PE	White	100	21-22	8.17
	25	Round	PE	White	100	24-25	9.89
	30	Round	PE	White	25	28-30	5.52
	32	Round	PE	White	25	30-32	5.98
	35	Round	PE	White	20	33-35	5.75
	40	Round	PE	White	12	36-40	4.60
	50	Round	PA	White	8	45-50	5.75



**CN102 圆头尼龙螺丝 Round nylon**



Model 型号	Size ((MM) 尺寸	Color/Material 颜色/材质	Size ((MM) 尺寸	Color/Material 颜色/材质	Size ((MM) 尺寸	Color/Material 颜色/材质	Size ((MM) 尺寸
CN102	3*5	White/PA	4*5	White	5*5	White/PA	6*8
	3*8	White/PA	4*8	White	5*8	White/PA	6*10
	3*10	White/PA	4*10	White	5*10	White/PA	6*12
	3*12	White/PA	4*12	White	5*12	White/PA	6*16
	3*16	White/PA	4*16	White	5*16	White/PA	6*20
	3*20	White/PA	4*20	White	5*20	White/PA	6*25
	3*25	White/PA	4*25	White	5*25	White/PA	6*30
	3*30	White/PA	4*30	White	5*30	White/PA	6*35
	3*35	White/PA	4*35	White	5*35	White/PA	6*40
	3*40	White/PA	4*40	White	5*40	White/PA	6*45
	3*45	White/PA	4*45	White	5*45	White/PA	6*50
	3*50	White/PA	4*50	White	5*50	White/PA	6*55

**CN103 外六角尼龙螺丝 Hex nylon screw**



Model 型号	Size ((MM) 尺寸	Color/Material 颜色/材质	Size ((MM) 尺寸	Color/Material 颜色/材质	Size ((MM) 尺寸	Color/Material 颜色/材质	Size ((MM) 尺寸
CN103	4*5	White/PA	6*60	White/PA	10*25	White/PA	14*16
	4*8	White/PA	6*65	White/PA	10*30	White/PA	14*20
	4*10	White/PA	6*70	White/PA	10*35	White/PA	14*25
	4*12	White/PA	6*75	White/PA	10*40	White/PA	14*30
	4*16	White/PA	8*6	White/PA	10*45	White/PA	14*35
	4*20	White/PA	8*8	White/PA	10*50	White/PA	14*40
	4*25	White/PA	8*10	White/PA	10*60	White/PA	14*45
	4*30	White/PA	8*12	White/PA	10*70	White/PA	14*50
	4*35	White/PA	8*16	White/PA	10*80	White/PA	14*55
	4*40	White/PA	8*20	White/PA	10*90	White/PA	14*60
	4*45	White/PA	8*25	White/PA	10*100	White/PA	14*70
	4*50	White/PA	8*30	White/PA	12*12	White/PA	14*80
	4*55	White/PA	8*35	White/PA	12*16	White/PA	14*90
	6*5	White/PA	8*38	White/PA	12*18	White/PA	14*100
	6*8	White/PA	8*40	White/PA	12*20	White/PA	16*30
	6*10	White/PA	8*45	White/PA	12*25	White/PA	16*35
	6*12	White/PA	8*50	White/PA	12*30	White/PA	16*40
	6*16	White/PA	8*60	White/PA	12*35	White/PA	16*45
	6*20	White/PA	8*70	White/PA	12*40	White/PA	16*50
	6*22	White/PA	8*80	White/PA	12*45	White/PA	16*55
	6*25	White/PA	8*90	White/PA	12*50	White/PA	16*60
	6*30	White/PA	8*100	White/PA	12*60	White/PA	16*65
	6*35	White/PA	10*13	White/PA	12*70	White/PA	16*70
	6*40	White/PA	10*16	White/PA	12*80	White/PA	16*75
6*45	White/PA	10*19	White/PA	12*90	White/PA	16*80	
6*50	White/PA	10*20	White/PA	12*100	White/PA	16*90	

**CN104 内六角塑料螺丝 Hexagon nylon screw**



Model 型号	Size ((MM) 尺寸	Color/Material 颜色/材质	Size ((MM) 尺寸	Color/Material 颜色/材质	Size ((MM) 尺寸	Color/Material 颜色/材质	Size ((MM) 尺寸
CN104	6*5	White/PA	8*16	White/PA	10*45	White/PA	14*30
	6*8	White/PA	8*20	White/PA	10*50	White/PA	14*35
	6*10	White/PA	8*25	White/PA	10*60	White/PA	14*40
	6*12	White/PA	8*30	White/PA	10*70	White/PA	14*45
	6*16	White/PA	8*35	White/PA	10*80	White/PA	14*50
	6*20	White/PA	8*40	White/PA	10*90	White/PA	14*55
	6*22	White/PA	8*45	White/PA	10*100	White/PA	14*60
	6*25	White/PA	8*50	White/PA	12*12	White/PA	14*70
	6*30	White/PA	8*60	White/PA	12*16	White/PA	14*80
	6*35	White/PA	8*70	White/PA	12*20	White/PA	14*100
	6*40	White/PA	8*80	White/PA	12*25	White/PA	16*30
	6*45	White/PA	8*90	White/PA	12*30	White/PA	16*35
	6*50	White/PA	8*100	White/PA	12*35	White/PA	16*40
	6*60	White/PA	10*13	White/PA	12*40	White/PA	16*45
	6*65	White/PA	10*16	White/PA	12*45	White/PA	16*50
	6*70	White/PA	10*19	White/PA	12*50	White/PA	16*55
	6*75	White/PA	10*20	White/PA	12*60	White/PA	16*60
	8*6	White/PA	10*25	White/PA	12*70	White/PA	16*65
	8*8	White/PA	10*30	White/PA	14*16	White/PA	16*70
	8*10	White/PA	10*35	White/PA	14*20	White/PA	16*80
	8*12	White/PA	10*40	White/PA	14*25	White/PA	16*90

**CN105 平头尼龙螺丝 Flat head screw**



Model 型号	Size ((MM) 尺寸	Color/Material 颜色/材质	Size ((MM) 尺寸	Color/Material 颜色/材质	Size ((MM) 尺寸	Color/Material 颜色/材质	Size ((MM) 尺寸
CN105	3*5	White/PA	4*5	White/PA	5*5	White/PA	6*8
	3*8	White/PA	4*8	White/PA	5*8	White/PA	6*10
	3*10	White/PA	4*10	White/PA	5*10	White/PA	6*12
	3*12	White/PA	4*12	White/PA	5*12	White/PA	6*16
	3*16	White/PA	4*16	White/PA	5*16	White/PA	6*20
	3*20	White/PA	4*20	White/PA	5*20	White/PA	6*25
	3*25	White/PA	4*25	White/PA	5*25	White/PA	6*30
	3*30	White/PA	4*30	White/PA	5*30	White/PA	6*35
	3*35	White/PA	4*35	White/PA	5*35	White/PA	6*40
	3*40	White/PA	4*40	White/PA	5*40	White/PA	6*45
	3*45	White/PA	4*45	White/PA	5*45	White/PA	6*50
	3*50	White/PA	4*50	White/PA	5*50	White/PA	*

**CN201 尼龙螺帽螺母 Nylon nut**

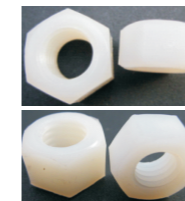

Model 型号	Size ((MM) 尺寸	Color/Material 颜色/材质	Size ((MM) 尺寸	Color/Material 颜色/材质	Size ((MM) 尺寸	Color/Material 颜色/材质	Size ((MM) 尺寸
CN201	M3	White/PA	M6	White/PA	M12	White/PA	M18
	M4	White/PA	M8	White/PA	M14	White/PA	M20
	M5	White/PA	M10	White/PA	M16	White/PA	*

**CN202 塑料盖头螺帽 Plastic cap**

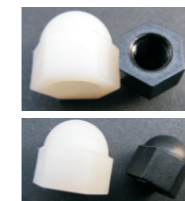

Model 型号	Size ((MM) 尺寸	Color/Material 颜色/材质	Size ((MM) 尺寸	Color/Material 颜色/材质	Size ((MM) 尺寸	Color/Material 颜色/材质	Size ((MM) 尺寸
CN202	M3	White/PA	M6	White/PA	M12	White/PA	M18
	M4	White/PA	M8	White/PA	M14	White/PA	M20
	M5	White/PA	M10	White/PA	M16	White/PA	*



六角隔离柱 HEXAGONAL THREADED SPACER

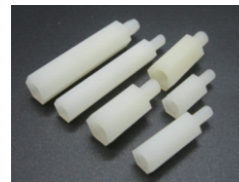

MATERIAL :  
NYLON 66  
FLAME  
CLASS : 94V-2  
COLOR :  
NATURAL  
用途 : 做为PC板与机板间之固定, 六角型不滑动。

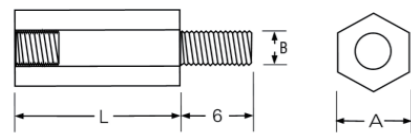

NUIT : mm

Item No.	A	B	L	Packing
HTS-306	5.6	M3	6.0	1000PCS
HTS-307	5.6		7.0	
HTS-308	5.6		8.0	
HTS-310	5.6		10.0	
HTS-312A	5.6		12.0	
HTS-312	5.6		12.7	
HTS-315	5.6		15.0	
HTS-318	5.6		18.0	
HTS-320	5.6		20.0	
HTS-322	5.6		22.0	
HTS-325	5.6	25.0		
HTS-330	5.6	30.0		
HTS-410	7.0	M4	10.0	1000PCS
HTS-413	7.0		13.0	
HTS-415	7.0		15.0	
HTS-419	7.0		19.0	
HTS-425	7.0		25.0	

六角隔离柱 HEXAGONAL THREADED SPACER



MATERIAL :  
NYLON 66  
FLAME  
CLASS : 94V-2  
COLOR :  
NATURAL  
用途 : 做为PC板与机板间之固定, 六角型不滑动。

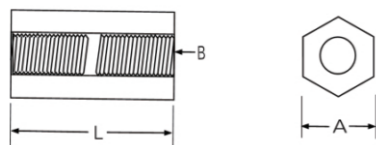

NUIT : mm

Item No.	A	B	L	Packing
HTP-306	5.6	M3	6.0	1000PCS
HTP-308			8.0	
HTP-310			10.0	
HTP-312			12.7	
HTP-315			15.0	
HTP-318			18.0	
HTP-320			20.0	
HTP-322			22.0	
HTP-325			25.0	
HTP-330			30.0	
HTP-410	7.0	M4	10.0	1000PCS
HTP-413	7.0		10.0	
HTS-415	7.0		15.0	
HTS-419	7.0		19.0	
HTS-425	7.0		25.0	

英制六角隔离柱 HEXAGONAL THREADED SPACER

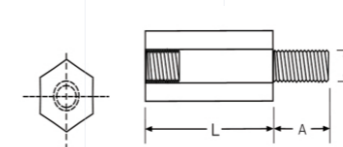

MATERIAL : NYLON 66  
FLAME CLASS : 94V-2  
COLOR : NATURAL  
用途 : 做为PC板与机板间之固定, 六角型不滑动。

NUIT : inch

Item No.	A	B	L	Packing		
HTS4-40X1/4	7/32	#4-40	1/4	1000PCS		
HTS4-40X3/8	7/32		3/8			
HTS4-40X1/2	7/32		1/2			
HTS4-40X5/8	7/32		5/8			
HTS4-40X3/4	7/32		3/4			
HTS4-40X7/8	7/32		7/8			
HTS4-40X1	7/32		1			
HTS6-32X1/4	9/32		#6-32		1/4	1000PCS
HTS6-32X3/8	9/32				3/8	
HTS6-32X1/2	9/32				1/2	
HTS6-32X5/8	9/32	5/8				
HTS6-32X3/4	9/32	3/4				
HTS6-32X7/8	9/32	7/8				
HTS6-32X1	9/32	1				
HTS8-32X1/4	13/32	#8-32		1/4	1000PCS	
HTS8-32X3/8	13/32			3/8		
HTS8-32X1/2	13/32			1/2		
HTS8-32X5/8	13/32		5/8			
HTS8-32X3/4	13/32		3/4			
HTS8-32X7/8	13/32		7/8			
HTS8-32X1	13/32		1			

英制六角隔离柱 HEXAGONAL THREADED SPACER

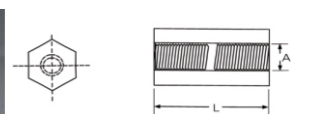
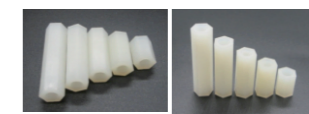

MATERIAL : NYLON  
FLAME CLASS : 94V-2  
COLOR : NATURAL  
用途 : 做为PC板与机板间之固六角型不滑动。

NUIT : inch

Item No.	A	L	Packing		
HTP4-40X1/4	#4-40	1/4	1000PCS		
HTP4-40X3/8		3/8			
HTP4-40X1/2		1/2			
HTP4-40X5/8		5/8			
HTP4-40X3/4		3/4			
HTP4-40X7/8		7/8			
HTP4-40X1		1			
HTP6-32X1/4		#6-32		1/4	1000PCS
HTP6-32X3/8				3/8	
HTP6-32X1/2				1/2	
HTP6-32X5/8	5/8				
HTP6-32X3/4	3/4				
HTP6-32X7/8	7/8				
HTP6-32X1	1				
HTP8-32X1/4	#8-32		1/4	1000PCS	
HTP8-32X3/8			3/8		
HTP8-32X1/2			1/2		
HTP8-32X5/8		5/8			
HTP8-32X3/4		3/4			
HTP8-32X7/8		7/8			
HTP8-32X1		1			

尼龙铆钉 SNAP RIVER

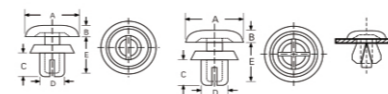

MATERIAL : NYLON 66  
FLAME CLASS : 94V-2  
COLOR : NATURAL

用途 : 用于PC板, 铁板零件固定 代替螺丝, 省时不需工具。

NUIT : mm

Item No.	Diam et er	适用板厚	A	B	C	D	E	拔拉力	Packing						
R2024	2.1	0.6-1.2	4.2	1.2	2.4	2.0	3.8	3Kg	1000PCS						
R2032		1.3-3.0			3.2										
R2040		2.1-2.8			4.0										
R2048		2.9-3.6			4.8										
R2056		3.7-4.4			5.6										
R2064		4.5-5.2			6.4										
R2632		1.0-2.0			3.2					5.0	1.4	2.6	4.6	5Kg	1000PCS
R2642		2.1-3.0			4.2										
R2648		2.7-3.6			4.8										
R2655		3.4-4.3			5.5										
R2664	4.3-5.2	6.4													
R2672	5.1-6.0	7.2													
R3035	1.0-2.0	3.5	6.4	1.6	3.0	5.1	8Kg	1000PCS							
R3045	2.0-3.0	4.5													
R3055	3.0-4.0	5.5													
R3065	4.0-5.0	6.5													
R3075	5.0-6.0	7.5													
R3080	5.5-6.5	8.0													
R3090	6.5-7.5	9.0													
R3100	7.5-8.5	10.0													
R3230	20.5-21.5	23.0							8.0	1.8	4.0	11.0	20Kg	1000PCS	
R3535	1.2-2.1	3.5													
R3545	2.2-3.1	4.5													
R3550	2.7-3.6	5.0													
R3555	3.2-4.1	5.5													
R3560	3.7-4.6	6.0													
R3570	4.7-5.5	7.0													
R3580	5.7-6.6	8.0													
R4050	2.5-3.5	5.0	9.0	2.2	5.0	6.5	25Kg	1000PCS							
R4060	3.5-4.5	6.0													
R4070	4.5-5.5	7.0													
R4080	5.5-6.5	8.0													
R4090	6.5-7.5	9.0													
R4100	7.5-8.5	10.0													
R4120	9.0-10.5	12.0													
R5045	1.5-2.5	4.5							12.0	2.5	6.0	9.0	30Kg	1000PCS	
R5055	2.5-3.5	5.5													
R5065	3.5-4.5	6.5													
R5075	4.5-5.5	7.5													
R5085	5.5-6.5	8.5													
R5095	6.5-7.5	9.5													
R5105	7.5-8.5	10.5													
R6060	2.5-4.0	6.0													
R6080	4.0-5.5	8.0													

固定扣 SNAP LATCHES



MATERIAL : NYLON 66  
FLAME CLASS : 94V-2  
COLOR : BLACK

用途: 固定於两片铁板, 一般用於机器的门扣, 拆卸方便。

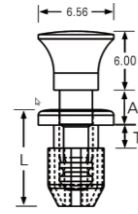

NUIT : mm

Item No.	L	T	A	Packing
SRG-1S	9.0	1.2	4.0	1000PCS
SRG-2S	9.5	1.6	4.0	

固定扣 SNAP LATCHES



MATERIAL : NYLON 66  
FLAME CLASS : 94V-2  
COLOR : BLACK

用途: 固定於两片铁板, 一般用於机器的门扣, 拆卸方便。

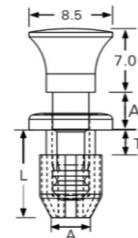

NUIT : mm

Item No.	L	T	A	Packing
SRG-1	9.8	1.2	5.0	1000PCS
SRG-2	10.2	1.6	5.0	
SRG-3	11.2	2.5	5.0	
SRG-4	12.8	4.1	5.0	

固定扣 SNAP LATCHES



MATERIAL : NYLON 66  
FLAME CLASS : 94V-2  
COLOR : NATURAL

用途: 固定於两片铁板, 一般用於机器的门扣, 拆卸方便。

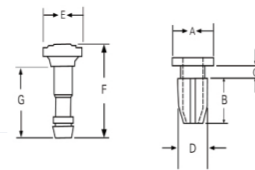

NUIT : mm

Item No.	A	B	C	D	E	F	G	Packing
SR-0809	8.5	7.1	1.9	6.3	7.1	13.6	11.0	1000PCS
SR-0810	8.5	7.1	1.9	6.3	8.1	18.4	11.5	
SR-1010	10.8	7.4	2.6	8.0	9.2	19.1	12.9	

固定扣 SNAP LATCHES



MATERIAL : NYLON 66  
FLAME CLASS : 94V-2  
COLOR : BLACK

用途: 固定於两片铁板, 一般用於机器的门扣, 拆卸方便。

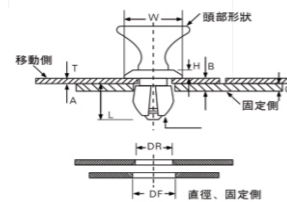

头部形状

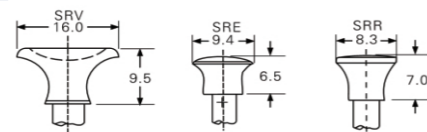

NUIT : mm

Item No.	W	H	L	T	G	取付口径		Packing
						移动侧	固定侧	
SRV-0	10.8	2.0	8.6	1.1	1.5~3.7	7.6 ±0.1	8.1 ±0.1	1000PCS
SRV-1			9.0	1.6	2.0~4.2			
SRV-2			10.0	2.5	3.0~5.2			
SRV-3			11.7	4.1	4.6~6.9			
SRV-4	12.9	5.3	5.8~8.1					
SRE-0	10.8	2.0	8.6	1.1	1.5~3.7	7.6 ±0.1	8.1 ±0.1	
SRE-1			9.0	1.6	2.0~4.2			
SRE-2			10.0	2.5	3.0~5.2			
SRE-3			11.7	4.1	4.6~6.9			
SRE-4	12.9	5.3	5.8~8.1					
SRR-1	8.5	1.8	8.0	1.1	1.5~3.7	6.0 ±0.1	6.4 ±0.1	
SRR-2			8.5	1.6	2.0~4.2			
SRR-3			9.5	2.5	3.0~5.2			
SRR-4			11.0	4.1	4.6~6.9			

螺式接线头 ALL-PLASTIC CONNECTOR



MATERIAL:UREA  
Voltage:U1、U2 300V, U3 600Vo  
TEMPERATURE:105°C

用途: 使用于各种电器产品, 灯饰等产品的接线器材, 绝缘性安全可靠。

NUIT : mm

Item No.	Color	A	B	Screw -T thread ID	Suitable Wire Area A.W.G	Packing
U1	LELLOW	14.5	8.6	6.5	22-16	1000PCS
U2	LVORY	17.2	10.0	7.9	22-16	
U3	LVORY	22.2	11.1	9.1	22-14	

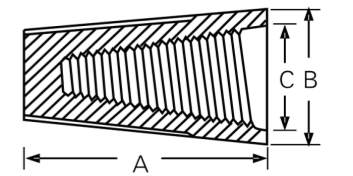
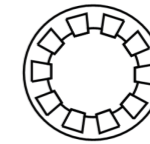

弹簧螺式接线头 SCREW-ON CONNECTOR



MATERIAL:UREA  
Voltage:U1、U2 300V, U3 600Vo  
TEMPERATURE:105°C

用途: 使用于各种电器产品, 灯饰等产品的接线器材, 绝缘性安全可靠。

NUIT : mm

Item No.	Color	High A	Width B	C	Suitable Wire Area A.W.G	Packing
P1	Orange	15.2	8.6	9.7	22-14	1000PCS
P2	Orange	17.6	9.8	7.4	22-14	
P3	Orange	22.0	12	9.9	22-14	
P4	Orange	24.5	14	11	22-10	500PCS
P6	Red	26.5	16.4	13	22-8	

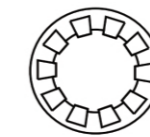

弹簧

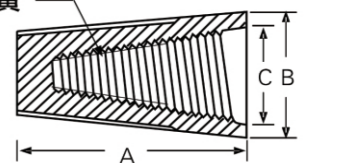

闭端端子 CLOSE-END CONNECTOR



MATERIAL:NYLON 66 FLAME CLASS:94V-2  
COLOR:NATURAL  
Voltage : 300V  
TEMPERATURE : 105°C  
用途: 使用于各种电器产品, 灯饰、家庭配线等接线器材。

NUIT : mm

Item No.	Hihg A	Breadth B	C	Suitable Wire Area		Packing
				平方线	A.W.G	
CE-1X	18.0	6.2	2.6	1.25	#22-16	1000PCS
CE-2X	19.7	7.9	3.0	2.0	#16-14	
CE-5X	25.5	10.5	4.0	5.5	#12-10	
CE-8	27.7	12.4	5.3	8.0	#8	500PCS

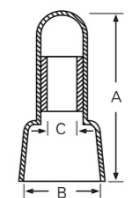

闭端端子 WIRE MOUNT



MATERIAL:NYLON 66  
FLAME CLASS:94V-2  
COLOR:NATURAL  
用途: 电线剥去外皮插入端子内, 用工具压著即可, 接触良好不脱落。

NUIT : mm

Item No.	Wire Range	A	B	C	D	E	Packing
C3	#22-16	2.5	7.9	19.2	7.2	5.1	1000PCS
C4	#16-14 2mm <sup>2</sup>	3.2	8.2	20.7	8.5	5.7	
C5	#12-10 5.5mm <sup>2</sup>	4.2	10.6	24.8	10.7	7.3	
C8	#8	5.0	12.2	27.1	12.5	9.2	500PCS

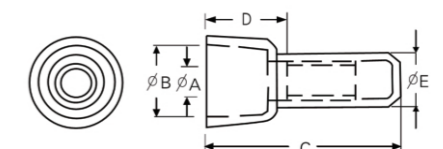



门扣 DOOR LACHES

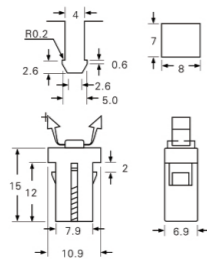

MATERIAL : NYLON 66 FLAME CLASS : 94V-2 COLOR : BLACK

用途: 用于机器之开关门扣, 方便机器门之开与关。

NUIT

Item No.	Packing
SRC-1	1000PCS

铆钉 FLASTIC RIVET

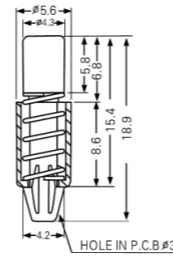

MATERIAL : NYLON 66 FLAME CLASS : 94V-2 COLOR : BLACK

用途: 用于PC板上IC与散热片间固定, 方便, 牢固。

NUIT : mm

Item No.	A	Packing
SRC-13	13.6	1000PCS

铆钉 FLASTIC RIVET

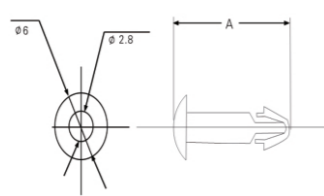

MATERIAL : NYLON 66 FLAME CLASS : 94V-2 COLOR : BLACK

用途: 用于PC板上IC与散热片间固定, 方便, 牢固。

NUIT : mm

Item No.	A	Packing
SRC-13	13.6	1000PCS
SRC-15	15.8	

尼龙铆钉 FLASTIC RIVET

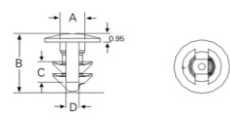
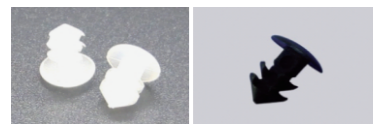

MATERIAL : NYLON 66 FLAME CLASS : 94V-2 COLOR : BLACK/NATURAL

用途: 用于铁板、PC板等板子间的结合固定。

Item No.	A	B	C	D	Packing
LRD-1	2.5	6.2	2.15	1.25	1000PCS

尼龙铆钉 FLASTIC RIVET

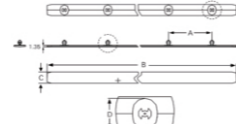

MATERIAL : NYLON 66 FLAME CLASS : 94V-2 COLOR : BLACK

用途: 用于铁板、PC板等板子间的结合固定。

NUIT : mm

Item No.	A	B	C	D	Packing
LRD-2	38.1	####	###	9.53	1000PCS

平底隔离柱 REVERSE LOCKING CIRCUIT BOARD SUPPORT

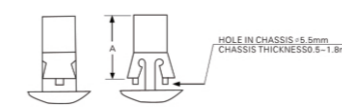

MATERIAL : NYLON 66(UL) FLAME CLASS : 94V-2 COLOR : NATURAL

使用方法: 先将基板钻孔 5.5mm, 再将隔离柱由底面推入固定后, 再把PC板固定即可。

特点: 无需工具, 即可固定PC板; 更换或维修PC板时, 拆卸容易。

NUIT : mm

Item No.	A	Packing
RLS-5	5.0	1000PCS
RLS-6	6.4	
RLS-8	8.0	
RLS-10	9.6	
RLS-12	12.0	
RLS-14	14.0	
RLS-16	16.0	
RLS-18	18.0	

PC板隔离柱 REVERSE LOCKING CIRCUIT BOARD SUPPORT

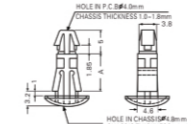

MATERIAL : NYLON 66(UL) FLAME CLASS : 94V-2 COLOR : NATURAL

用途: 固定PC板于机板上, 不会突出机板底部, 外观美丽。

NUIT : mm

Item No.	A	Packing
RCD-3	3.0	1000PCS
RCD-6	6.3	
RCD-8	8.0	
RCD-10	10.0	
RCD-11	11.0	

PC板隔离柱 REVERSE LOCKING CIRCUIT BOARD SUPPORT

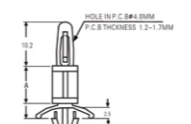

MATERIAL : NYLON 66(UL) FLAME CLASS : 94V-2 COLOR : NATURAL

用法: 先将基板钻如图示之底孔, 再将隔离柱由大孔处放入角推入小孔即可固定。

用途: 固定PC板于机板上, 免工具, 易卸。

NUIT : mm

Item No.	A	Packing
LCS-3	3.5	1000PCS
LCS-5	4.8	
LCS-6	6.4	
LCS-8	7.9	
LCS-10	9.6	
LCS-12	12.7	
LCS-16	15.9	
LCS-19	19.1	
LCS-22	22.2	

平底隔离柱 REVERSE LOCKING CIRCUIT BOARD SUPPORT

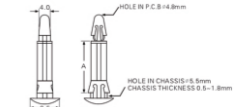

MATERIAL : NYLON 66(UL) FLAME CLASS : 94V-2 COLOR : NATURAL

使用方法: 先将基板钻孔 5.5mm, 再将隔离柱由底面推入固定后, 再把PC板固定即可。

特点: 无需工具, 即可固定PC板; 更换或维修PC板时, 拆卸容易。

NUIT : mm

Item No.	A	Packing
RS-6	6.5	1000PCS
RS-8	8.0	
RS-10	10	
RS-12	12.0	
RS-14	14.0	
RS-16	16.0	
RS-18	18.0	

PC板隔离柱 REVERSE LOCKING CIRCUIT BOARD SUPPORT



MATERIAL : NYLON 66(UL) FLAME CLASS : 94V-2 COLOR : NATURAL

用法: 免工具, 用手装卸容易。使用时先将基板钻孔4.8mm后将隔离柱固定, 再将PC板套入即可。

用途: PC板固定用。

NUIT : mm

Item No.	A	Packing
CS-5	4.8	1000PCS
CS-6	6.4	
CS-10	9.5	
CS-12	12.7	
CS-16	15.9	
CS-19	19.0	
CS-22	22.0	

PC板隔离柱 REVERSE LOCKING CIRCUIT BOARD SUPPORT

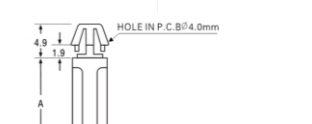

MATERIAL : NYLON 66(UL) FLAME CLASS : 94V-2 COLOR : NATURAL

用法: 先将基板钻孔 4.0mm。

特点: 无需工具, 即可固定PC板; 更换或维修PC板时, 拆卸容易; PC板与PC板间之固定不占空间。

NUIT : mm

Item No.	A	Packing
AS-3	3.5	1000PCS
AS-5	4.8	
AS-6	6.4	
AS-8	7.9	
AS-10	10.5	
AS-11.5	12.7	
AS-12	12.7	
AS-16	19.0	
AS-19	19.0	
AS-22	22.2	

PC 板隔离柱 REVERSE LOCKING CIRCUIT BOARD SUPPORT



MATERIAL : NYLON 66(UL)  
FLAME CLASS : 94V-2  
COLOR : NATURAL

用法: 先将基板钻孔 4.0mm.  
特点: 无需工具, 即可固定PC板; 更换或维修PC板时, 拆卸容易, PC板与PC板间之固定不占空间.

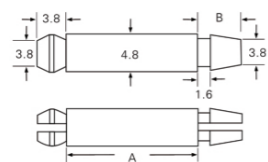

NUIT : mm			
Item No.	A	B	Packing
SP-3	3.2	3.8	1000PCS
SP-5	5.0	3.8	
SP-6	6.3	3.8	
SP-8	8.0	3.8	
SP-9			
SP-10	10.5	3.8	
SP-12	12.7	5.6	
SP-16	15.9	5.6	
SP-19	19.0	5.6	
SP-22	22.0	5.6	
SP-25	25.4	5.6	

PC 板隔离柱 REVERSE LOCKING CIRCUIT BOARD SUPPORT



MATERIAL : NYLON 66(UL)  
FLAME CLASS : 94V-2  
COLOR : NATURAL

用法: 先将基板钻孔 3.0mm.  
特点: 无需工具, 即可固定PC板; 更换或维修PC板时, 拆卸容易; PC板与PC板间之固定不占空间.

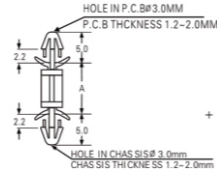

NUIT : mm		
Item No.	A	Packing
SST-3	3.2	1000PCS
SST-5	5.0	
SST-6	6.35	
SST-7	7.0	
SST-8	8.0	
SST-10	9.5	
SST-11	11.0	
SST-12	12.0	
SST-15	15.0	
SST-17	17.0	
SST-20	20.2	
SST-25	25.4	

PC 板隔离柱 REVERSE LOCKING CIRCUIT BOARD SUPPORT



MATERIAL : NYLON 66(UL)  
FLAME CLASS : 94V-2  
COLOR : NATURAL

用法: 先将基板钻孔4.0mm, 将隔离柱固定, 再把PC板固定即可.  
特点: 固定PC板于机板上, 免工具, 易拆卸.

NUIT : mm

Item No.	A	Packing
ES-3	3.5	2000PCS
ES-5	5.0	
ES-6	6.3	1000PCS
ES-7	7.4	
ES-8	8.0	
ES-9	9.0	
ES-11	11.0	
ES-12	12.7	
ES-15	15.9	

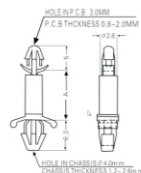

PC 板隔离柱 REVERSE LOCKING CIRCUIT BOARD SUPPORT



MATERIAL : NYLON 66(UL)  
FLAME CLASS : 94V-2  
COLOR : NATURAL

用法: 先将基板钻孔3.5mm, 将隔离柱固定, 再把PC板固定即可.  
特点: 固定PC板于机板上, 免工具, 易拆卸.

NUIT : mm

Item No.	A	Packing
ST-3	3.2	2000PCS
ST-4	4.0	
ST-5	4.8	1000PCS
ST-6	6.4	
ST-7	7.0	
ST-8	8.0	
ST-9	9.4	
ST-10	10.4	
ST-11	11.2	
ST-12	12.7	
ST-16	16.0	
ST-19	19.1	

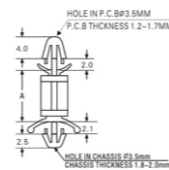

PC 板隔离柱 REVERSE LOCKING CIRCUIT BOARD SUPPORT

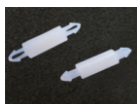

MATERIAL : NYLON 66(UL)  
FLAME CLASS : 94V-2  
COLOR : NATURAL

用法: 先将基板钻孔 3.0mm.  
特点: 无需工具, 即可固定PC板; 更换或维修PC板时, 拆卸容易; PC板与PC板间之固定不占空间.

NUIT : mm

Item No.	A	Packing
SU-4	4.0	1000PCS
SU-5	5.0	
SU-6	6.0	
SU-8	8.0	
SU-10	10.5	
SU-16	16	

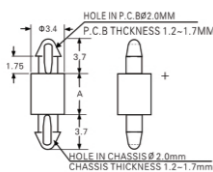

PC 板隔离柱 REVERSE LOCKING CIRCUIT BOARD SUPPORT

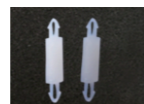

MATERIAL : NYLON 66(UL)  
FLAME CLASS : 94V-2  
COLOR : NATURAL

用法: 先将基板钻孔 3.0mm.  
特点: 无需工具, 即可固定PC板; 更换或维修PC板时, 拆卸容易; PC板与PC板间之固定不占空间.

NUIT : mm

Item No.	A	Packing
SO-4	4.0	1000PCS
SO-5	5.0	
SO-6	6.0	
SO-8	8.0	
SO-10	10.5	
SO-16	16	

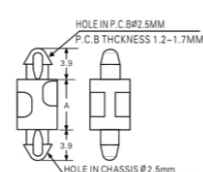

PC 板隔离柱 REVERSE LOCKING CIRCUIT BOARD SUPPORT



MATERIAL : NYLON 66(UL)  
FLAME CLASS : 94V-2  
COLOR : NATURAL

用法: 先将基板钻孔 3.0mm.  
特点: 无需工具, 即可固定PC板; 更换或维修PC板时, 拆卸容易; PC板与PC板间之固定不占空间.

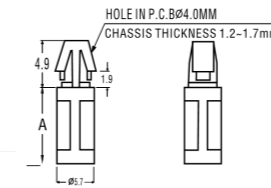

NUIT : mm

Item No.	A	Packing
MC-3	3.0	2000PCS
MC-4	4.0	
MC-5	5.0	
MC-6	6.3	
MC-7	7.0	
MC-8	8.0	
MC-10	10.0	
MC-12	12.7	

PC 板隔离柱 REVERSE LOCKING CIRCUIT BOARD SUPPORT



MATERIAL : NYLON 66(UL)  
FLAME CLASS : 94V-2  
COLOR : NATURAL

用法: 先将基板钻如图所示之底孔, 再将隔离柱由大孔处放入角推入小孔即可固定.  
用途: 固定PC板, 拆卸容易.

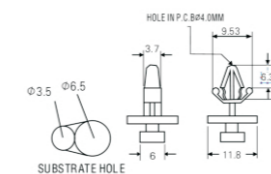

NUIT : mm

Item No.	A	Packing
MS-8	11.4	1000PCS

推式隔离柱 SLIDE SECURE CIRCUIT BOARD SUPPORT



MATERIAL : NYLON 66(UL)  
FLAME CLASS : 94V-2  
COLOR : NATURAL

用法: 先将基板钻如图所示之底孔, 再将隔离柱由大孔处放入角推入小孔即可固定.  
用途: 固定PC板, 拆卸容易.

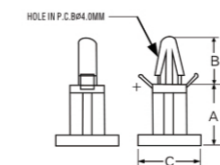

NUIT : mm

Item No.	Spacing			Packing
	A	B	C	
BMS-5	5.5	9.5	11.8	100PCS (1000PCS)
BMS-8	7.8	9.5	11.8	
BMS-11	11.0	9.0	12.0	

PC 板隔离柱 REVERSE LOCKING CIRCUIT BOARD SUPPORT



MATERIAL : NYLON 66(UL)  
FLAME CLASS : 94V-2  
COLOR : NATURAL

用法: 先将基板钻孔 4.0mm.  
特点: PC板直接压入固定, 另一头配合螺丝或攻牙.

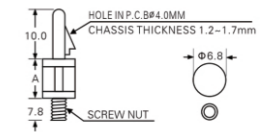

NUIT : mm

Item No.	A	Packing
SPT-6	6.4	1000PCS
SPT-8	8.0	
SPT-10	9.5	
SPT-12	12.7	
SPT-16	15.9	

PC 板隔离柱 REVERSE LOCKING CIRCUIT BOARD SUPPORT



MATERIAL : NYLON 66(UL)  
FLAME CLASS : 94V-2  
COLOR : NATURAL

用途: 不需底座机器之PC板固定.  
特点: 强力错式设计PC板不会滑动, 底部不凸出.

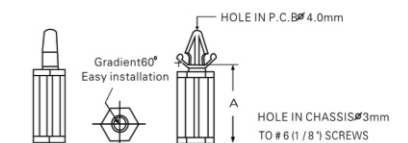

NUIT : mm

Item No.	A	Packing
SPP-5	5.0 ( 3/16" )	(1000PCS)
SPP-10	9.6(3/8")	
SPP-13	12.7(1/2")	
SPP-19	19.1(3/4")	
SPP-28	28.5(1 1/8")	
SPP-35	35.0(1 3/8")	





PC板隔离柱 REVERSE LOCKING CIRCUIT BOARD SUPPORT



MATERIAL:NYLON 66(UL)  
FLAME CLASS:94V-2  
COLOR:NATURAL  
用途:作为PC板与机板间之垫高与固定用。

NUIT : mm

Item No.	A	Packing
2-2	2.0	2000PCS
2-3	3.0	
2-4	4.0	
2-5	5.0	
2-6	6.0	
2-7	7.0	
2-8	8.0	
2-9	9.0	
2-10	10.0	
2-11	11.0	
2-12	12.0	
2-13	13.0	
2-14	14.0	
2-15	15.0	
2-16	16.0	

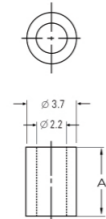

PC板隔离柱 REVERSE LOCKING CIRCUIT BOARD SUPPORT

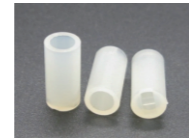

MATERIAL:NYLON 66(UL)  
FLAME CLASS:94V-2  
COLOR:NATURAL  
用途:作为PC板与机板间之垫高与固定用。

NUIT : mm

Item No.	A	Packing
2.6-2	2.0	2000PCS
2.6-3	3.0	
2.6-4	4.0	
2.6-5	5.0	
2.6-6	6.0	
2.6-7	7.0	
2.6-8	8.0	
2.6-9	9.0	
2.6-10	10.0	
2.6-11	11.0	
2.6-12	12.0	
2.6-13	13.0	
2.6-14	14.0	
2.6-15	15.0	
2.6-16	16.0	

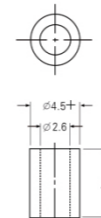

圆体隔离柱 ROUND SPACER



MATERIAL:NYLON 66(UL)  
FLAME CLASS:94V-2  
COLOR:NATURAL  
用途:做为PC板之垫高用。

NUIT :

Item No.	L	Packing
3-5-2	2.0	2000PCS
3-5-3	3.0	
3-5-4	4.0	
3-5-5	5.0	
3-5-6	6.0	
3-5-7	7.0	
3-5-8	8.0	
3-5-9	9.0	
3-5-10	10.0	
3-5-11	11.0	
3-5-12	12.0	1000PCS
3-5-13	13.0	
3-5-14	14.0	
3-5-15	15.0	
3-5-16	16.0	
3-5-17	17.0	
3-5-18	18.0	
3-5-19	19.0	
3-5-20	20.0	
3-5-21	21.0	
3-5-22	22.0	
3-5-23	23.0	
3-5-24	24.0	
3-5-25	25.0	
3-5-26	26.0	
3-5-27	27.0	
3-5-28	28.0	
3-5-29	29.0	
3-5-30	30.0	

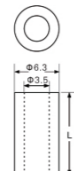
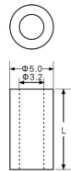

NUIT :

Item No.	L	Packing
3.5-2	2.0	2000PCS
3.5-3	3.0	
3.5-4	4.0	
3.5-5	5.0	
3.5-6	6.0	
3.5-7	7.0	
3.5-8	8.0	
3.5-9	9.0	
3.5-10	10.0	
3.5-11	11.0	
3.5-12	12.0	1000PCS
3.5-13	13.0	
3.5-14	14.0	
3.5-15	15.0	
3.5-16	16.0	
3.5-17	17.0	
3.5-18	18.0	
3.5-19	19.0	
3.5-20	20.0	
3.5-21	21.0	
3.5-22	22.0	
3.5-23	23.0	
3.5-24	24.0	
3.5-25	25.0	
3.5-26	26.0	
3.5-27	27.0	
3.5-28	28.0	
3.5-29	29.0	
3.5-30	30.0	

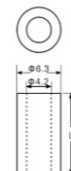

NUIT :

Item No.	L	Packing
4-2	2.0	2000PCS
4-3	3.0	
4-4	4.0	
4-5	5.0	
4-6	6.0	
4-7	7.0	
4-8	8.0	
4-9	9.0	
4-10	10.0	
4-11	11.0	
4-12	12.0	1000PCS
4-13	13.0	
4-14	14.0	
4-15	15.0	
4-16	16.0	
4-17	17.0	
4-18	18.0	
4-19	19.0	
4-20	20.0	
4-21	21.0	
4-22	22.0	
4-23	23.0	
4-24	24.0	
4-25	25.0	
4-26	26.0	
4-27	27.0	
4-28	28.0	
4-29	29.0	
4-30	30.0	

圆体隔离柱 ROUND SPACER

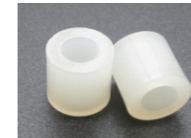

MATERIAL:NYLON 66(UL)  
FLAME CLASS:94V-2  
COLOR:NATURAL  
用途:做为PC板之垫高用。

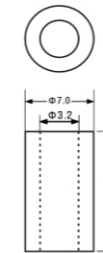

NUIT : mm

Item No.	L	Packing
3-7-2	2.0	2000PCS
3-7-3	3.0	
3-7-4	4.0	
3-7-5	5.0	
3-7-6	6.0	
3-7-7	7.0	
3-7-8	8.0	
3-7-9	9.0	
3-7-10	10.0	
3-7-11	11.0	
3-7-12	12.0	1000PCS
3-7-13	13.0	
3-7-14	14.0	
3-7-15	15.0	
3-7-16	16.0	
3-7-17	17.0	
3-7-18	18.0	
3-7-19	19.0	
3-7-20	20.0	
3-7-21	21.0	
3-7-22	22.0	
3-7-23	23.0	
3-7-24	24.0	
3-7-25	25.0	
3-7-26	26.0	
3-7-27	27.0	
3-7-28	28.0	
3-7-29	29.0	
3-7-30	30.0	

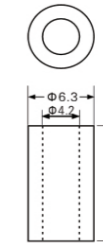

NUIT : mm

Item No.	L	Packing
4-2	2.0	2000PCS
4-3	3.0	
4-4	4.0	
4-5	5.0	
4-6	6.0	
4-7	7.0	
4-8	8.0	
4-9	9.0	
4-10	10.0	
4-11	11.0	
4-11	11.5	1000PCS
4-12	12.0	
4-13	13.0	
4-14	14.0	
4-15	15.0	
4-16	16.0	
4-17	17.0	
4-18	18.0	
4-19	19.0	
4-20	20.0	
4-21	21.0	
4-22	22.0	
4-23	23.0	
4-24	24.0	
4-25	25.0	
4-26	26.0	
4-27	27.0	
4-28	28.0	
4-29	29.0	
4-30	30.0	

PC板拉柄 CARD PULLER



MATERIAL:NYLON 66(UL), P, B, T  
FLAME CLASS : 94V-2, 94V-0  
COLOR : NATURAL  
用途:与PC板导槽配合,可快速将PC板拉出与压入。

NUIT : mm

Item No.	Packing
CP-15	1000PCS

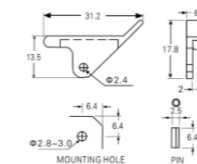

PC板耳把 Ear the PC board



MATERIAL:NYLON 66(UL), P, B, T  
FLAME CLASS : 94V-2, 94V-0  
COLOR : NATURAL  
用途:与PC板导槽配合,可快速将PC板拉出与压入。  
PC板钻孔: 2.5-2.6mm, 适用PC板厚度1.6mm

NUIT : mm

Item No.	Packing
CP-25	100PCS

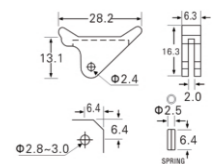



**PC板耳把 Ear the PC board**

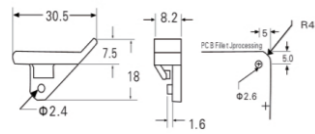

MATERIAL:NYLON 66(UL) , P、B、T  
 FLAME CLASS : 94V-2  
 COLOR : NATURAL  
 用途 : 与PC板导槽配合,可快速将PC板拉出与压入。  
 PC板钻孔 : 2.5-2.6mm。适用PC板厚度1.6mm

NUIT : mm

Item No.	Packing
CP-05	100PCS

**隔离柱 Isolation column**

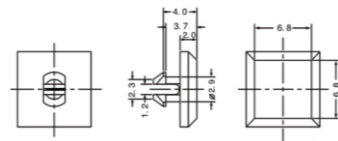
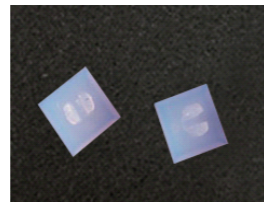

MATERIAL:NYLON 66  
 FLAME CLASS : 94V-2  
 COLOR : NATURAL  
 用途 : 保护TO-220包装之晶体立于PC板上,使接脚不弯曲、折断、短路、且高度一致

NUIT : mm

Item No.	Packing
M196	1000PCS

**PC板导槽 PC board guide**

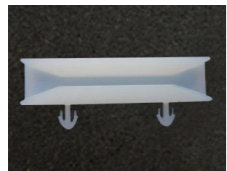

MATERIAL:NYLON 66(UL) , P、B、T  
 FLAME CLASS : 94V-2  
 COLOR : NATURAL  
 特点 : 固定PC板於机壳上,安装方便,免螺丝。

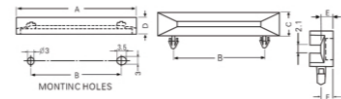

Item No.	A	B	C	D	E	F	PC.B THICKNESS	Packing
HCG38-2	38.4	20.0	9.2	6.4	3.4	3.2	2.0	100PCS
HCG80-2	81.0	60.0	8.0	6.0	3.0	3.0	1.8-2.1	
HCG90-2	91.5	71.0	8.0	6.0	3.0	3.0	1.8-2.1	

**PC板导槽 PC board guide**

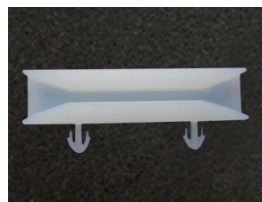

MATERIAL:NYLON 66(UL) , P、B、T  
 FLAME CLASS : 94V-2  
 COLOR : NATURAL  
 特点 : 固定PC板於机壳上,安装方便,免螺丝。

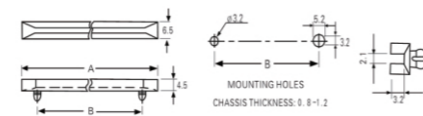

Item No.	A	B	Packing
CG-250	63.5	50.8	500PCS
CG-300	76.2	63.5	
CG-350	88.9	76.2	
CG-400	101.6	88.9	250PCS
CG-450	114.3	101.6	200PCS
CG-500	127.0	114.3	
CG-550	139.7	127.0	
CG-600	152.4	139.7	

**PC板轨道 PC board track**

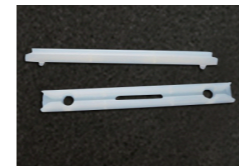

MATERIAL:NYLON 66(UL) , P、B、T  
 FLAME CLASS : 94V-2  
 COLOR : NATURAL  
 用法 : 以3mmX6mm平底螺帽2组,将轨道固定,再将PC板嵌入即可,轨道中增有2个防震片可保护PC板防止震动。

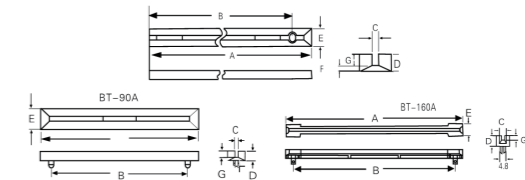

Item No.	A	B	C	D	E	F	G	Packing
BT-90A	89	77	1.9	4.5	9.5	1.5	3	1000PCS
BT-90	89	64.5	1.9	4.5	9.5	1.5	3	
BT-120	119	94.5	1.9	4.5	9.5	1.5	3	
BT-140	140	115.0	1.9	4.5	9.5	1.5	3	
BT-155A	153.5	140.5	2.0	4.6	9.5	1.3	3.3	
BT-160	160	134.5	1.9	4.5	9.5	1.5	3	
BT-160A	163	149.5	1.9	4.5	9.5	2.2	2.3	

**PC板导槽 PC board guide**



MATERIAL:POM  
 FLAME CLASS : 94V-2  
 COLOR : BLACK  
 用途 : 固定PC板於机壳上,安装方便,免螺丝。

NUIT : mm

Item No.	Packing
450ICV30605	100PCS

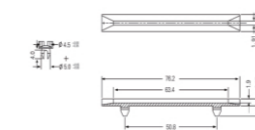

**PC板导槽 PC board guide**



MATERIAL:POM  
 FLAME CLASS : 94V-2  
 COLOR : BLACK  
 用途 : 固定PC板於机壳上,安装方便,免螺丝。

NUIT : mm

Item No.	Packing
450ICV30618	100PCS

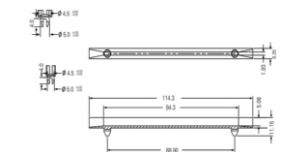

**LED间隔柱 LED interval column**



MATERIAL : NYLON 66(UL)  
 FLAME CLASS : 94V-2  
 COLOR : NATURAL  
 用途 : 用于保护LED灯立于PC板上,使高度一致,中间隔板设计,接脚不会弯曲、折断、短路。

NUIT : mm

Item No.	L	Packing
LED-2	2.0	2000PCS
LED-2.5	2.5	
LED-3	3.0	
LED-3.5	3.5	
LED-4	4.0	
LED-4.5	4.5	
LED-5.0	5.0	
LED-5.5	5.5	
LED-6.0	6.0	
LED-6.5	6.5	
LED-7.0	7.0	

Item No.	L	Packing
LED-10	10.0	1000PCS
LED-11	11.0	
LED-12	12.0	
LED-13	13.0	
LED-14	14.0	
LED-15	15.0	
LED-16	16.0	
LED-17	17.0	
LED-18	18.0	
LED-19	19.0	
LED-20	20.0	
LED-21	21.0	
LED-22	22.0	
LED-23	23.0	
LED-24	24.0	
LED-25	25.0	
LED-26	26.0	
LED-27	27.0	
LED-28	28.0	
LED-29	29.0	
LED-30	30.0	

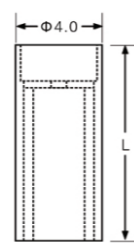
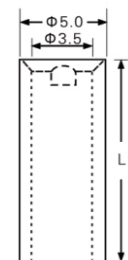
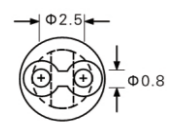

Item No.	L	Packing
LEDS-10	10.0	2000PCS
LEDS-11	11.0	
LEDS-12	12.0	
LEDS-13	13.0	
LEDS-14	14.0	
LEDS-15	15.0	
LEDS-16	16.0	
LEDS-17	17.0	
LEDS-18	18.0	
LEDS-19	19.0	
LEDS-20	20.0	
LEDS-21	21.0	
LEDS-22	22.0	
LEDS-23	23.0	
LEDS-24	24.0	
LEDS-25	25.0	
LEDS-26	26.0	
LEDS-27	27.0	
LEDS-28	28.0	
LEDS-29	29.0	
LEDS-30	30.0	

**LED隔离柱 LED isolation column**

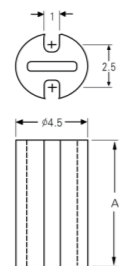

MATERIAL : NYLON 66(UL)  
 FLAME CLASS : 94V-2  
 COLOR : NATURAL/BLACK  
 用途 : 使LED立于PC板上, 高度一致, 不断脚。

NUIT : mm

Item No.	A	Packing
LEDH-2	2.0	2000PC
LEDH-2.5	2.5	
LEDH-3	3.0	
LEDH-3.5	3.5	
LEDH-4	4.0	
LEDH-4.5	4.5	
LEDH-5	5.0	
LEDH-5.5	5.5	
LEDH-6	6.0	
LEDH-6.5	6.5	

Item No.	A	Packing
LEDH-7	7.0	2000PC
LEDH-7.5	7.5	
LEDH-8	8.0	
LEDH-8.5	8.5	
LEDH-9	9.0	
LEDH-9.5	9.5	
LEDH-10	10.0	
LEDH-10.5	10.5	
LEDH-11	11.0	
LEDH-11.5	11.5	
LEDH-12	12.0	
LEDH-12.5	12.5	
LEDH-13	13.0	
LEDH-13.5	13.5	
LEDH-14	14.0	
LEDH-14.5	14.5	
LEDH-15	15.0	
LEDH-15.5	15.5	

**LED座 LED SPACER SUPPORT**

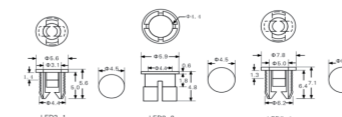

NUIT : mm

MATERIAL:POM  
 FLAME CLASS : 94V-2  
 COLOR : BLACK  
 用途 : 可快速将LED固定于机器面板上。

Item No.	Packing
LED3-1	1000PCS
LED3-2	
LED5-1	

**LED座 LED SPACER SUPPORT**

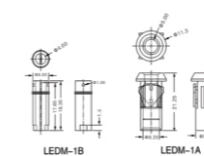

NUIT : mm

MATERIAL:POM  
 FLAME CLASS : 94V-2  
 COLOR : BLACK  
 用途 : 可快速将LED固定于机器面板上。

Item No.	Packing
LEDM-1A	1000PCS
LEDM-1B	

**LED座 LED SPACER SUPPORT**

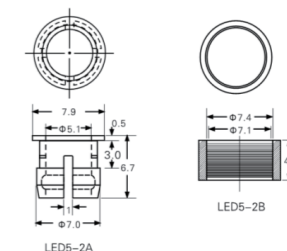
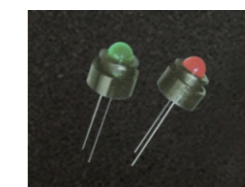

MATERIAL:POM  
 FLAME CLASS : 94V-2  
 COLOR : BLACK  
 用途 : 可快速将LED固定于机器面板上。

NUIT : mm

Item No.	Packing
LED5-2A	1000PCS
LED5-2B	

**LED隔离柱 LED isolation column**

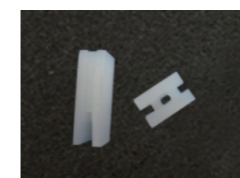

MATERIAL : NYLON 66(UL)  
 FLAME CLASS : 94V-2  
 COLOR : NATURAL/BLACK

用途 : 保护变色LED(3PIN)固定PC板上,使接脚不会弯曲, 拆断, 并使用LED高度一致。

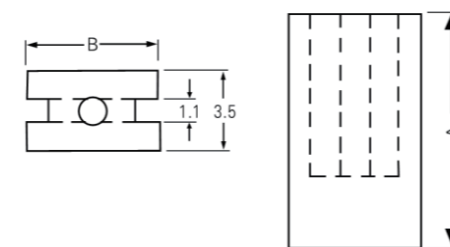

NUIT : mm

Item No.	A	B	Packing
LED3X3	3.0	5.7	2000PCS
LED3X4	4.0	5.7	
LED3X5	5.0	5.7	
LED3X6	6.0	5.7	
LED3X7	7.0	5.7	
LED3X8	8.0	5.7	
LED3X9	9.0	5.7	1000PCS
LED3X10	10.0	5.7	
LED3X11	11.0	6.0	
LED3X12	12.0	5.7	
LED3X13	13.0	5.7	
LED3X14	14.0	5.7	
LED3X15	15.0	7.0	
LED3X16	16.0	5.7	
LED3X17	17.0	5.7	
LED3X18.0	18.0	5.7	
LED3X18.5	18.5	5.7	
LED3X19	19.0	5.7	



垫块 block



MATERIAL : POM  
FLAME CLASS : 94V-2  
COLOR : BLACK  
用途 : 固定PC板,拆卸容易.

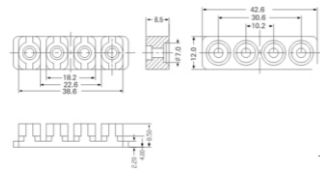

NUIT : mm

Item No.	Packing
M198	1000PCS

垫块 block

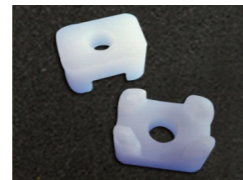

MATERIAL:POM  
FLAME CLASS : 94V-2  
COLOR : NATURAL  
用途 : 固定PC板,拆卸容易.

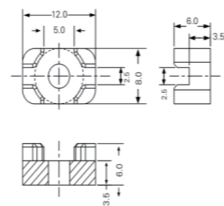

NUIT : mm

Item No.	Packing
M197	1000PCS

LED座 LED SPACER SUPPORT

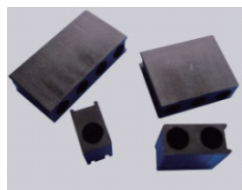

MATERIAL : POM  
FLAME CLASS : 94V-2  
COLOR : BLACK  
用途 : 使LED成90°C焊于PC板上高度一致,不断脚.

NUIT : mm

Item No.	Applicability	Packing
LED-301	Φ 3	1000PCS
LED-302		
LED-303		
LED-304		
LED-501	Φ 5	
LED-502		

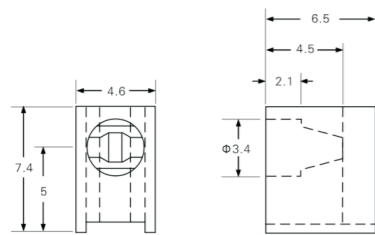

LED-301

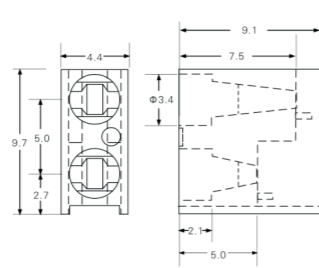

LED-302

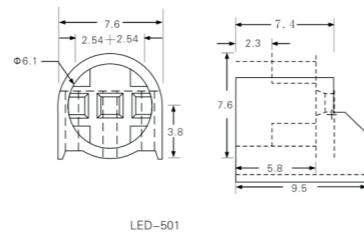

LED-501

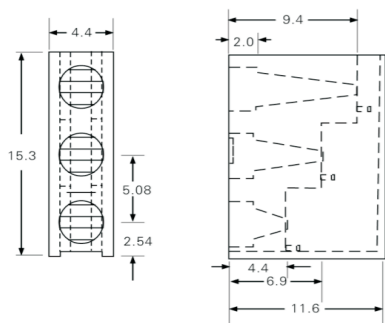

LED-303

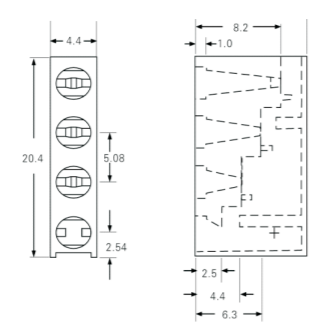

LED-304

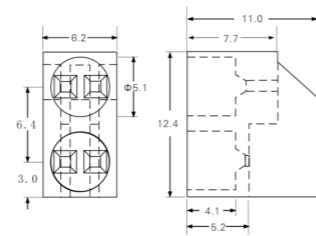

LED-502

电晶体垫片 Transistor gasket

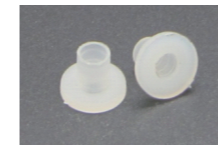

MATERIAL : NYLON 66(UL)  
FLAME CLASS : 94V-2  
COLOR : NATURAL  
用途 : 锁於电晶体上,避免晶体外壳散热片间造成短路.

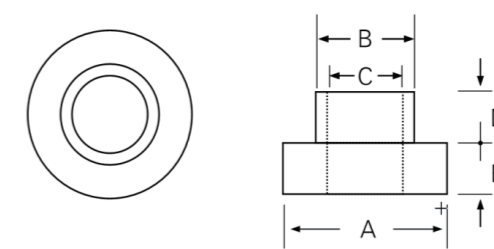

NUIT : mm

Item No.	A	B	C	D	E	Packing
TO-220	6.0	3.5	3.0	1.5	1.2	2000PCS
TO-220A	6.0	3.5	3.0	2.0	1.2	
TO-220B	6.0	3.5	3.0	2.5	1.5	
TO-220D	6.0	3.5	3.0	3.0	1.5	
TO-3	8.0	3.8	3.0	3.0	2.0	1000PCS
TO-5	10.0	5.0	3.8	5.6	1.5	

电晶体座 Transistor seat

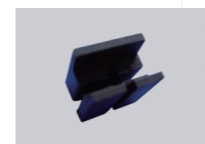

MATERIAL : NYLON 66(UL)  
FLAME CLASS : 94V-2  
COLOR : NATURAL/BLACK  
用途 : 保护TO-220包装之晶体立于PC板上,使接脚不弯曲、折断、短路、且高度一致.

NUIT : mm

Item No.	Packing
TR-1	1000PCS

电晶体座 Transistor seat



MATERIAL : NYLON 66(UL)  
FLAME CLASS : 94V-2  
COLOR : NATURAL  
用途 : 保护TO-220包装之晶体立于PC板上,使接脚不弯曲、折断、短路、且高度一致.

NUIT : mm

Item No.	A	B	Packing
TR-2	5.0	8.5	1000PCS

电晶体垫片 Transistor gasket

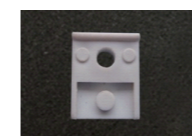

MATERIAL : P . B . T  
FLAME CLASS : 94V-2  
COLOR : NATURAL  
用途 : 用于散热片上之晶体外壳,绝缘性佳,防止高压跳火.耐高温.

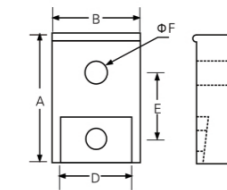

NUIT : mm

Item No.	A	B	C	D	E	F	Packing
TC-1	16.0	13.0	5.4	10.7	8.0	3.5	100PCS

电晶体座 Transistor seat

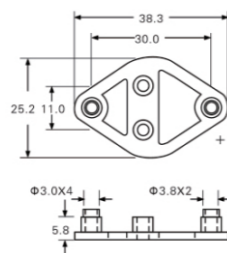

MATERIAL : NYLON 66(UL)

FLAME CLASS : 94V-2

COLOR : NATURAL

用途 : 用于TO-3功率晶体与散热之间, 作为绝缘保护之用。

NUIT : mm

Item No.	Packing
TH-1	1000PCS

电晶体座 Transistor seat

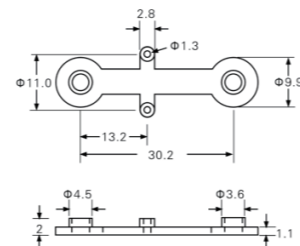

MATERIAL : NYLON 66(UL)

FLAME CLASS : 94V-2

COLOR : NATURAL

用途 : 用于TO-3功率晶体与散热之间, 作为绝缘保护之用。

NUIT : mm

Item No.	Packing
TH-1	1000PCS

电晶体座 Transistor seat

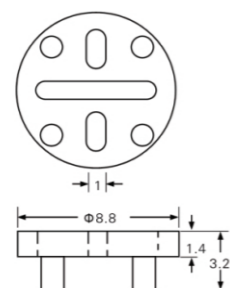
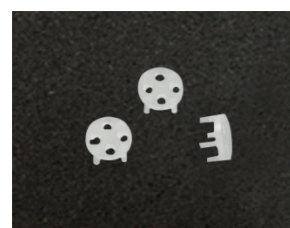

MATERIAL : NYLON 66(UL)

FLAME CLASS : 94V-2

COLOR : NATURAL

用途 : 用于TO-5功率晶体与散热之间, 作为绝缘保护之用。

NUIT : mm

Item No.	Packing
T0-05	1000PCS

电容器护套 CAPACITOR COVER

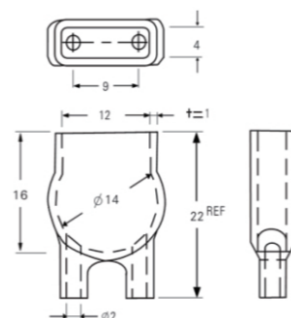

MATERIAL : PVC

FLAME CLASS : 94V-0

用途 : 用于电容器之绝缘与防尘。

NUIT : mm

Item No.	Packing
HU-14	1000PCS

尼龙束线带 NYLON CABLE TIE

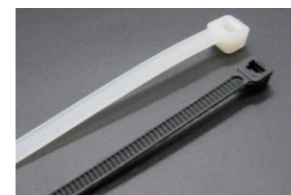

MATERIAL:NYLON 66  
FLAME CLASS:94V-2  
COLOR:NATURAL/BLACK

用途 : 适用于网络线、讯号线、电源线、及一般物品的捆扎。

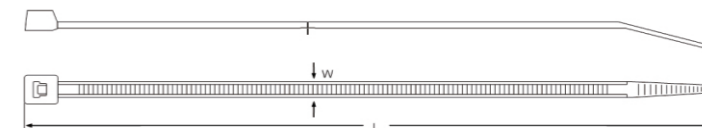

NUIT : mm

Item No.	L		W mm	Max.Bundle mm	Mix.Tensile Strength Packing		Packing			
	mm	inch			Ibs	kgs				
HSCT-80	80	3 1/5"	2.5	20	18	8	1000PCS			
HSCT-100	100	4"		25						
HSCT-120S	120	4 4/5"		30						
HSCT-150S	150	6"		39						
HSCT-200S	200	8"		55						
HSCT-120	120	4 4/5"	3.5	30	40	18	100PCS			
HSCT-150	150	6"		39						
HSCT-200	200	8"		55						
HSCT-250S	250	10"		74						
HSCT-300S	300	12"		88						
HSCT-200M	200	8"	4.8	55	50	22	100PCS (1000PCS)			
HSCT-250	250	10"		74						
HSCT-300	300	12"		88						
HSCT-350	350	14"		100						
HSCT-380	380	15"		110						
HSCT-400S	400	16"		120						
HSCT-450S	450	18"		130						
HSCT-500S	500	10"		150						
HSCT-200L	200	8"		7.6				55	120	55
HSCT-250L	250	10"						74		
HSCT-300L	300	12"	88							
HSCT-370L	370	14 1/2"	108							
HSCT-400	400	16"	120							
HSCT-450	450	18"	130							
HSCT-500	500	20"	150							

插销式固定座 PUSH TIE MOUNT

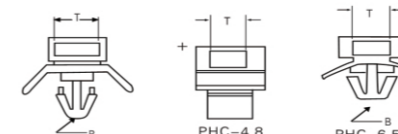

MATERIAL:NYLON 66  
FLAME CLASS:94V-2  
COLOR:NATURAL

用法 : 将基板钻孔, 再将插销式固定座插入固定於基板上, 复以扎线带穿入孔中, 即可使用。

NUIT : mm

Item No.	Hole T	Substrate Hole B	Packing
PHC-4	4.0	4.8	100PCS
PHC-6.5	6.5	8.5	
PHC-8	8.1	6.2	



**扎线固定座 SADDLE TYPE TIE MOUNT**



NUIT : mm

Item No.	H	L	W	T	B	Packing
STM-0	5.0	19	9.5	5.0	3.4	100PCS
STM-1	7.0	15	10	5.0	3.0	
STM-2	9.0	23	16	9.0	6.0	
STM-2S	9.0	23	16	9.0	5.0	

MATERIAL:NYLON 66  
FLAME CLASS:94V-2  
COLOR:NATURAL/BLACK

用途:先将固定座以螺丝固定,再以扎线带绕电缆,  
马鞍形设计使电缆易于固定。

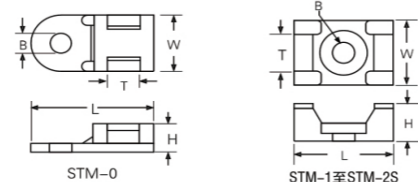

**扎线固定座 SADDLE TYPE TIE MOUNT**

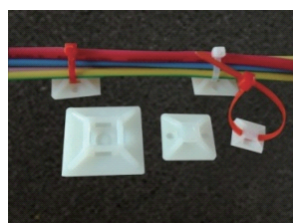

NUIT : mm

Item No.	H	L	W	Screw Hole	T	Packing
HS-100	12.5	12.5	3.2	--	3.2	100PCS
HS-101	21.0	21.0	3.5	--	4.7	
HS-101S	19.5	19.5	3.5	--	5.0	
HS-102	28.0	28.0	4.0	5.0	5.0	

MATERIAL:NYLON 66  
FLAME CLASS:94V-2  
COLOR:NATURAL/BLACK

用法:使用时将底面胶带撕去封纸,再将固定座贴于铁板上,  
扎线带穿于孔中,即可使用,可省去面板钻孔。

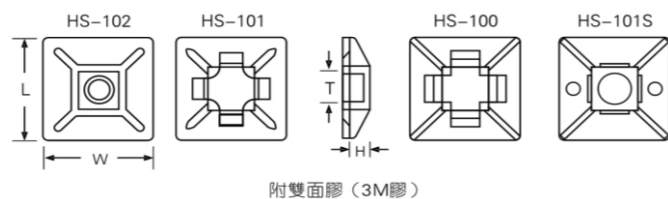

**可调式配线固定座 Adjustable wiring fixed seat**

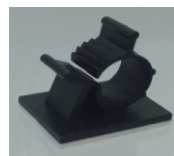

NUIT : mm

Item No.	BUNDLE OF LINE RANGE	B	C	D	E	F	Packing
AP-0810	7.9~10.3	25.4	22.2	19.1	1.6	10.2	100PCS
AP-1013	10.0~12.5	31.8	27.8	19.1	1.6	10.2	
AP-1316	12.6~15.4	38.1	31.8	19.1	1.6	12.7	
AP-1720	16.5~20.1	42.0	44.5	25.4	1.6	12.7	
AP-2225	22.2~25.4	42.0	44.5	25.4	1.6	12.7	

MATERIAL:NYLON 66  
FLAME CLASS:94V-2  
COLOR:GRAY

特点:背胶式装配简单、快速、牢固、开启容易,可多次重复使用。

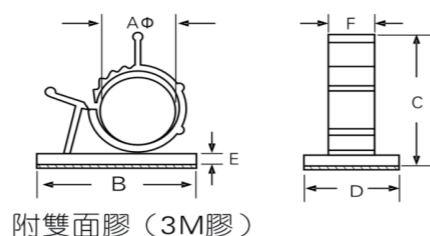

**粘式配线固定座 CABLE CLAMP**

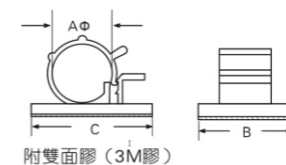
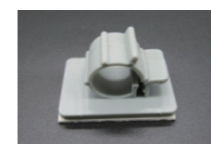

NUIT : mm

Item No.	AΦ	B	C	Packing
TS-0607	6~7	20.0	25	100PCS
TS-0708	7~8	20.0	25	
TS-0910	9~10	24.5	30	
TS-1214	12~14	24.5	30	
TS 16±8	16~18	24.5	30	

MATERIAL:NYLON 66  
FLAME CLASS:94V-2  
COLOR:GRAY

特点:背胶式装配简单、快速、牢固、开启容易,可多次重复使用。

**粘式配线固定座 CABLE CLAMP**

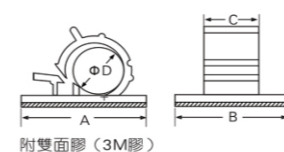

NUIT : mm

Item No.	A	B	C	D	Packing
FWS-1	21.0	19.0	9.2	8.2	100PCS
FWS-2	25.0	20.0	12.0	9.0	
FWS-3	25.0	19.7	12.1	10.6	
FWS-4	29.0	20.0	14.0	12.6	

MATERIAL:NYLON 66  
FLAME CLASS:94V-2  
COLOR:GRAY

特点:背胶式装配简单、快速、牢固、开启容易,可多次重复使用。

**电线固定座 WIRE LOCK MOUNT**

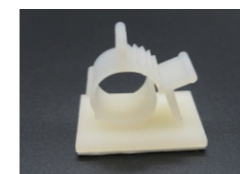

NUIT : mm

Item No.	A	B	C	D	Packing
AWC-1	24.8	18.8	10.2	7.9~10.3	100PCS
AWC-2	25.4	15.0	10.2	11.9~14.3	
AWC-2A	30.2	15.0	10.0	11.9~14.3	
AWC-3	34.4	18.8	12.7	14.7~19.1	
AWC-4	36.0	19.0	12.7	18.0~22.0	
AWC-5	39.8	19.8	13.0	22.0~26.5	

MATERIAL:NYLON 66  
FLAME CLASS:94V-2  
COLOR:GRAY

特点:背胶式装配简单、快速、牢固、开启容易,可多次重复使用。

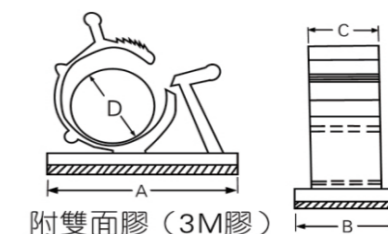

粘式配线固定座 CABLE CLAMP

NUIT : mm

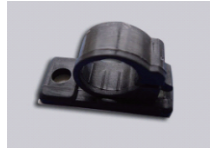

Item No.	Dimension						Packing
	A	B	T1	L	W	H	
4J-S	6	4.4	2.0	25.8	13.4	9.1	100PCS
6J-S	9	4.4	3.0	29.4	13.4	14.0	
8J-S	12	4.4	3.0	35.5	16.4	16.5	
10J-S	14	4.4	3.0	36.5	16.4	18.5	
11J-S	16	4.4	3.0	38.5	16.4	20.5	
12J-S	18	4.4	3.0	42.0	16.4	22.5	

MATERIAL:NYLON 66  
FLAME CLASS:94V-2  
COLOR:GRAY

特点:一般的固定座,都需要配合扎线链才可使用,本固定座则谨将电线置於圆孔中,轻轻一扣即可完成配线工作,更省钱又省时,可松开重 使用。

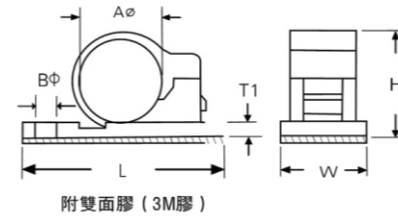

附雙面膠 (3M膠)

可调式配线固定座 ADJUSTABLE CABLE CLAMP

NUIT : mm



Item No.	A	B	L	Packing
CL-1	25.4	18.0	64.0	100PCS
CL-2	25.4	18.0	85.0	
CL-3	30.0	21.0	94.0	

MATERIAL:NYLON 66  
FLAME CLASS:94V-2  
COLOR:NATURAL/BLACK

用途:固定电线、背胶式,可钻孔更牢固。

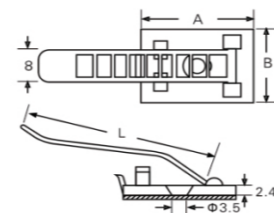

附雙面膠 (3M膠)

粘式扣线固定座 ADHESIVE WIRE SADDLE

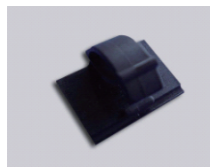

NUIT : mm

Item No.	A	B	Packing
WCC-1	10.0	6.3	100PCS
WCC-2	14.0	10.5	

MATERIAL:NYLON 66  
FLAME CLASS:94V-2  
COLOR:BLACK

用途:固定电线、背胶式、免钻孔。

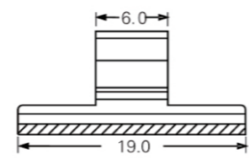
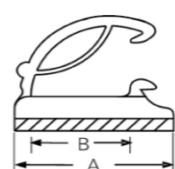

附雙面膠 (3M膠)

粘式固定座 SELF ADHESIVE TIE MOUNT

NUIT : mm

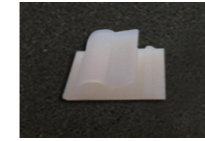

Item No.	Packing
WCL-1	100PCS

MATERIAL:NYLON 66  
FLAME CLASS:94V-2  
COLOR:NATURAL / BLACK

用途:固定电线、背胶式、免钻孔。

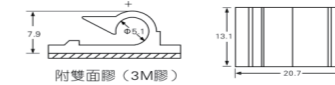

附雙面膠 (3M膠)

粘式固定座 SELF ADHESIVE TIE

NUIT : mm

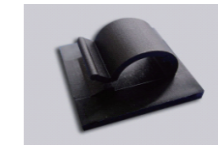

Item No.	Packing
WCL-2	100PCS

MATERIAL:NYLON 66  
FLAME CLASS:94V-2  
COLOR:NATURAL / BLACK

用途:固定电线、背胶式、免钻孔。

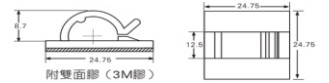

附雙面膠 (3M膠)

电线固定座 SELF ADHESIVE TIE MOUNT

NUIT : mm

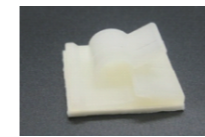

Item No.	Packing
WCT-5	100PCS

MATERIAL:NYLON 66  
FLAME CLASS:94V-2  
COLOR:NATURAL

用途:背胶式,固定电线於机器中,整齐美观。

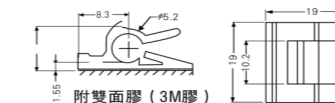

附雙面膠 (3M膠)

电线固定座 SELF ADHESIVE TIE

NUIT : mm

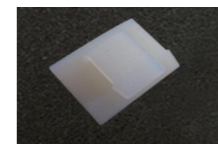

Item No.	Packing
WC-4	100PCS

MATERIAL:NYLON 66  
FLAME CLASS:94V-2  
COLOR:NATURAL

用途:背胶式,固定电线於机器中,整齐美观。

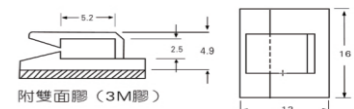

附雙面膠 (3M膠)

粘式固定座 SELF ADHESIVE TIE MOUNT

NUIT : mm

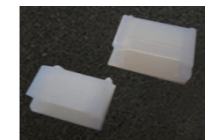

Item No.	A	B	C	D	Packing
FC-1	13.0	8.5	9.2	6.3	100PCS ( 1000PCS )
FC-2	16.0	11.5	13.0	9.0	

MATERIAL:NYLON 66  
FLAME CLASS:94V-2  
COLOR:NATURAL / BLACK

用途:固定电线、背胶式、免钻孔。

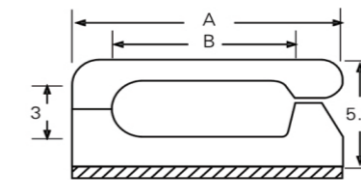

附雙面膠 (3M膠)

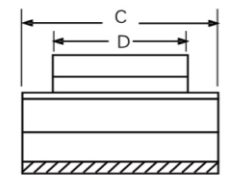



电线固定座 SELF ADHESIVE TIE MOUNT

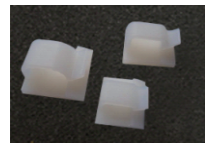

NUIT : mm

Item No.	A	B	C	D	E	F	Packing
WCL-4	16.0	14.4	7.1	8.2	5.2	8.8	100PCS
WCL-5	16.0	16.8	7.0	10.2	6.7	9.5	
WCL-6	19.0	19.0	9.7	12.5	8.1	11.0	
WCL-7	19.0	19.0	9.0	13.6	8.2	11.3	

MATERIAL:NYLON 66  
FLAME CLASS:94V-2  
COLOR:NATURAL

用途:背胶式,固定电线於机器中,整齐美观。

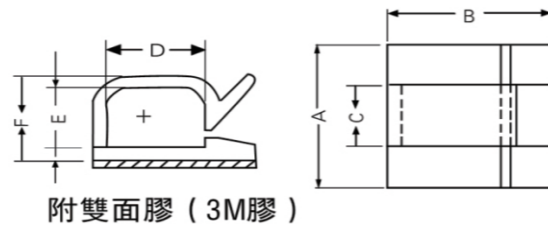

电线固定座 SELF ADHESIVE TIE MOUNT

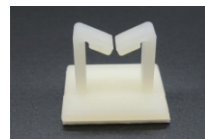

NUIT : mm

Item No.	Packing
WT-1	100PCS

MATERIAL:NYLON 66  
FLAME CLASS:94V-2  
COLOR:NATURAL

用途:背胶式,可快速拆卸,固定电线维修方便,不占空间。

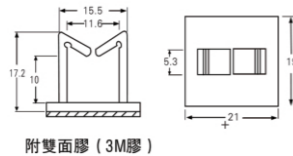

粘式配线固定座 ADJUSTABLE CABLE

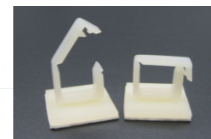

NUIT : mm

Item No.	Packing
WLM-1	100PCS

MATERIAL:NYLON 66  
FLAME CLASS:94V-2  
COLOR:NATURAL

用途:背胶式,可快速拆卸,固定电线维修方便,不占空间。

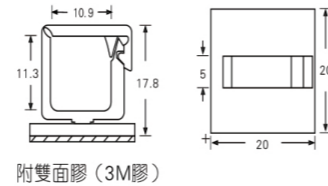

粘式固定座 SELF ADHESIVE TIE MOUNT



NUIT : mm

Item No.	A	B	C	Packing
SAN-1	14.0	Φ 8.6	16.0	100PCS

MATERIAL:NYLON 66  
FLAME CLASS:94V-2  
COLOR:NATURAL

用途:固定电线、背胶式、免钻孔。

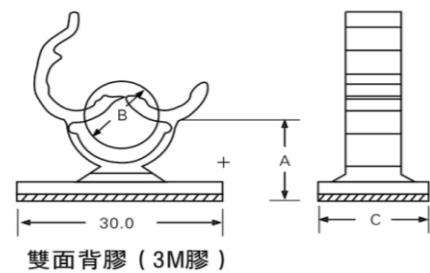

粘式固定座 SELF ADHESIVE TIE MOUNT



NUIT : mm

Item No.	Packing
WLL-1	100PCS

MATERIAL:NYLON 66  
FLAME CLASS:94V-2  
COLOR:NATURAL

用途:快速固定及解开电线、背胶式、免钻孔。

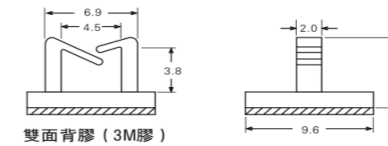

粘式固定座 SELF ADHESIVE TIE MOUNT



NUIT : mm

Item No.	Packing
SAM-1	100PCS

MATERIAL:NYLON 66  
FLAME CLASS:94V-2  
COLOR:NATURAL

用途:快速固定及解开电线、背胶式、免钻孔。

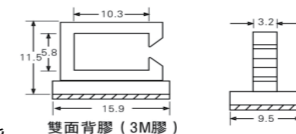

粘式固定座 SELF ADHESIVE TIE

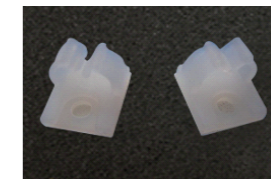

NUIT : mm

Item No.	Packing
SAT-1	100PCS

MATERIAL:NYLON 66  
FLAME CLASS:94V-2  
COLOR:NATURAL

用途:固定电线、背胶式,可钻孔更牢固。

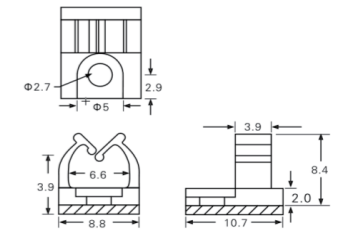

电线固定座 WIRE SADDLE



NUIT : mm

Item No.	Packing
WT-2	100PCS

MATERIAL:NYLON 66  
FLAME CLASS:94V-2  
COLOR:NATURAL

用途:背胶式,可快速固定及解开电线。

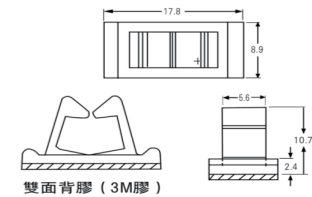

锁式固定夹 WIRE CLIP

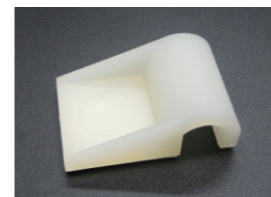

NUIT : mm

Item No.	A	B	C	Packing
HK-7	18.7	12.8	7.3	100PCS
HK-8	18.9	14.0	8.3	

MATERIAL:NYLON 66  
FLAME CLASS:94V-2  
COLOR:NATURAL

用途:固定排线,加强内观,作业方便,省时。

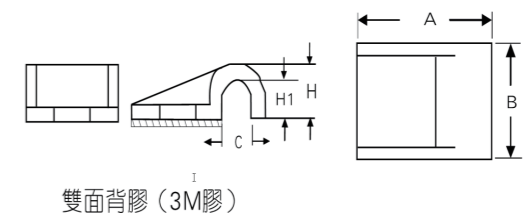

粘式固定座 SELF ADHESIVE TIE MOUNT



NUIT : mm

Item No.	A	W	H	Packing
FC-15	15.0	25.0	10.0	100PCS
FC-20	20.0	25.0	10.0	
FC-25	25.0	25.0	10.0	

MATERIAL:NYLON 66

FLAME CLASS:94V-2

COLOR:NATURAL

用途:快速固定及解开电线、背胶式、免钻孔。

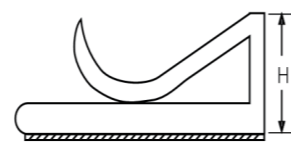
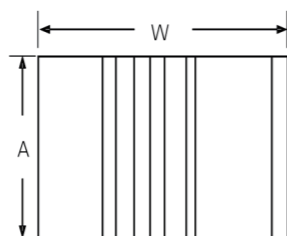

雙面背膠(3M膠)

粘式固定座 SELF ADHESIVE TIE MOUNT



NUIT : mm

Item No.	A	B	C	适用排线	Packing
FCB-30	19.0	45.0	32.0	30PIN	100PCS
FCB-40	19.0	54.0	40.0	40PIN	
FCB-50	19.7	77.6	64.0	50PIN	

MATERIAL:NYLON 66

FLAME CLASS:94V-2

COLOR:NATURAL

用途:快速固定及解开电线、背胶式、免钻孔。

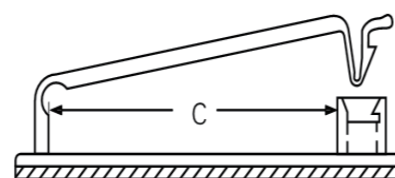
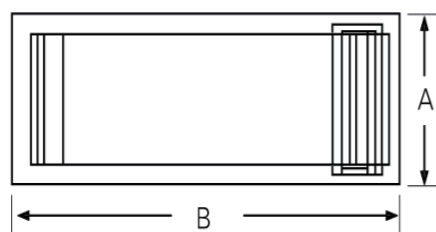

雙面背膠(3M膠)

粘式固定座 SELF ADHESIVE TIE MOUNT



NUIT : mm

Item No.	A	B	C	适用排线	Packing
FCB-30	19.0	45.0	32.0	30PIN	100PCS
FCB-40	19.0	54.0	40.0	40PIN	
FCB-50	19.7	77.6	64.0	50PIN	
FCB-64	19.7	88.6	72.0	60PIN	

MATERIAL:NYLON 66

FLAME CLASS:94V-2

COLOR:NATURAL

用途:快速固定及解开电线、背胶式、免钻孔。

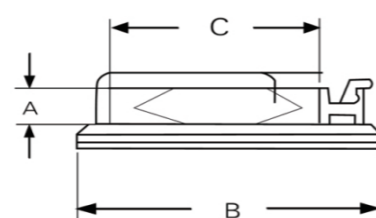

金属粘式固定夹 SELF ADHESIVE WIRE CLIP

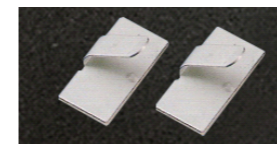

NUIT : mm

Item No.	A	B	C	Packing
SWC-1	20.0	10.0	12.5	100PCS
SWC-2	25.0	15.0	18.0	

MATERIAL:NYLON 66

FLAME CLASS:94V-2

COLOR:NATURAL

用途:固定电线、背胶式、免钻孔。

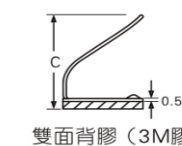
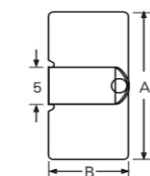

雙面背膠(3M膠)

电线固定座 WIRE MOUNT

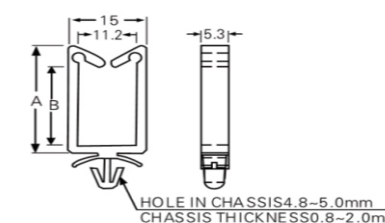
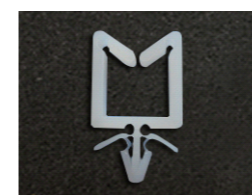

MATERIAL:NYLON 66

FLAME CLASS:94V-2

COLOR:NATURAL

用途:可快速固定电线,安装容易。

Item No.	A	B	Packing
CHA-1	12.0	5.0	1000PCS
CHA-2	17.0	10.0	500PCS
CHA-3	26.0	19.0	
CHA-4	34.0	27.0	

NUIT : mm

电线固定座 WIRE MOUNT

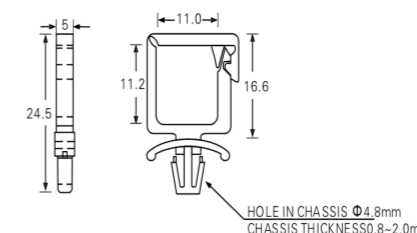
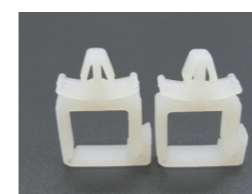

MATERIAL:NYLON 66

FLAME CLASS:94V-2

COLOR:NATURAL

用途:可快速固定电线,安装容易。

Item No.	Packing
CH-1	100PCS

NUIT : mm

电线固定座 WIRE MOUNT

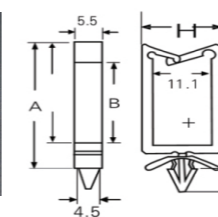

Item No.	Dimension			Packing
	H	A	B	
CH-5	9.2	12.7	2.8	100PCS (1000PCS)
CH-10	14.4	17.9	8.6	
CH-20	23.4	26.9	18.2	

NUIT : mm

MATERIAL:NYLON 66

FLAME CLASS:94V-2

COLOR:NATURAL

用途:可快速固定电线,安装容易。



电线固定座 WIRE MOUNT



NUIT : mm

Item No.	A	B	C	D	E	Packing
WM-1	12.0	8.8	11.5	8.5	3.5	1000PCS
WM-1S	9.2	6.8	7.6	5.0	3.0	

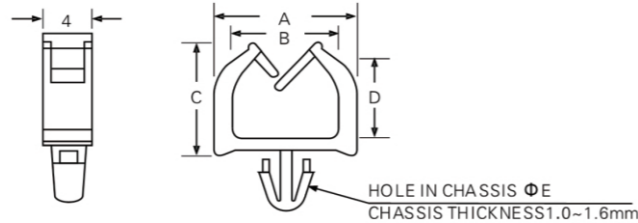

MATERIAL: NYLON 66  
 FLAME CLASS: 94V-2  
 COLOR: NATURAL  
 用途: 可快速固定电线, 安装容易。

扣式电线固定夹 WIRE CLIP

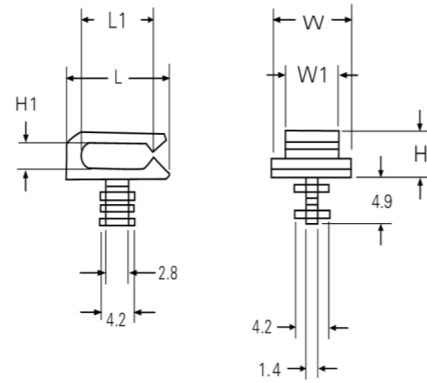

MATERIAL: NYLON 66  
 FLAME CLASS: 94V-2  
 COLOR: NATURAL  
 用途: 可快速固定电线, 安装容易。

Item No.	L	L1	W	W1	H	H1	Packing
FC-0903	12.8	8.9	9.8	6.6	5	2.8	1000PCS

粘式束线环 MOUNTING TWIST TIE



NUIT : mm

Item No.	A	B	C	Packing
KL-1	15.0	20.0	20.0	100PCS
KL-2	9.0	14.0	20.0	
KL-3	11.5	20.0	20.0	
KL-4	20.0	25.0	25.0	
KL-5	17.0	13.0	25.0	

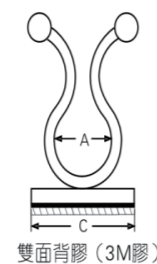

MATERIAL: NYLON 66  
 FLAME CLASS: 94V-2  
 COLOR: NATURAL  
 用途: 背胶式, 可快速捆扎及解开电线, 可重复使用。

电线束线环 TWIST TIE



NUIT : mm

Item No.	A	B	C	Packing
TT-5	17.8	5.1	4.0	1000PCS
TT-8	23.8	8.3	7.3	
TT-11	28.0	11.5	10.0	
TT-15	30.4	15.4	13.8	
TT-18	35.0	18.8	17.2	500PCS
TT-25	41.4	25.8	24.2	

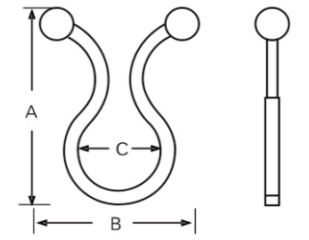

MATERIAL: NYLON 66  
 FLAME CLASS: 94V-2  
 COLOR: NATURAL  
 用途: 用于配线中, 可快速捆扎及解开电线, 可重复使用。

扣式护线套 SNAP BUSHINGS



NUIT : mm

Item No.	A	B	Packing
ST-8	34	9.0	1000PCS
ST-11	40	10.8	
ST-15	49	18.5	

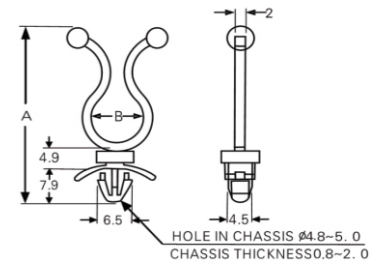

MATERIAL: NYLON 66  
 FLAME CLASS: 94V-2  
 COLOR: NATURAL  
 用途: 用于配线中, 可快速捆扎及解开电线, 可重复使用。

电线束线座 WIRE HOLDER



NUIT : mm

Item No.	A	B	C	Packing
TT-5	17.8	5.1	4.0	1000PCS
TT-8	23.8	8.3	7.3	
TT-11	28.0	11.5	10.0	
TT-15	30.4	15.4	13.8	
TT-18	35.0	18.8	17.2	500PCS
TT-25	41.4	25.8	24.2	

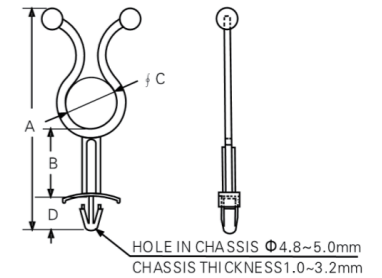

MATERIAL: NYLON 66  
 FLAME CLASS: 94V-2  
 COLOR: NATURAL  
 用途: 可快速捆扎及解开电线, 安装容易。

防高压线环 F-B-T CLIP



NUIT : mm

Item No.	A	B	C	D	Fitcable	Packing
WMD-1	49.5	7.8	22.0	5.0	4.5-5.3	100PCS
WMD-2	49.5	7.8	22.0	5.0	3.5-4.5	

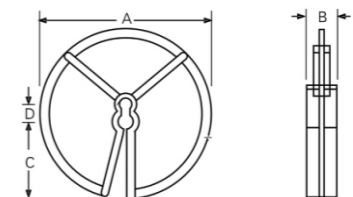

MATERIAL: NYLON 66  
 FLAME CLASS: 94V-2  
 COLOR: NATURAL  
 用途: 保护CRT高压线与管壁间之绝缘, 使用方便。

配线固定钮 CABLE CLAMP



MATERIAL:NYLON 66  
FLAME CLASS:94V-2  
COLOR:NATURAL

用途:配合螺丝,固定电线,使之整齐美观。

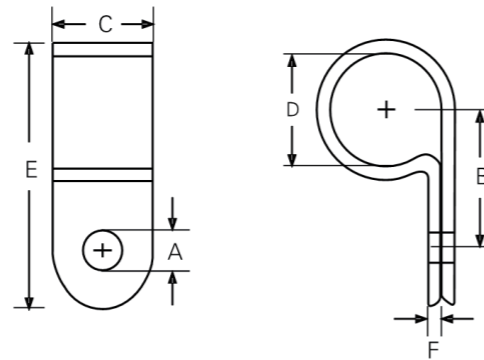

Item No.	A	B	C	D	E	F	Packing
CC-0	4.6	9.5	9.6	3.2(1/8")	19.8	1.4	100PCS 1000PCS
CC-0.5	4.6	10.5	9.6	4.8(3/16")	19.8	1.4	
CC-1	4.6	12.0	10	6.35(1/4")	22.0	1.4	
CC-1.5	4.6	12.0	10	7.9(5/16")	22.0	1.5	
CC-2	4.6	12.5	12	9.5(3/8")	24.0	1.5	
CC-3	4.6	15.2	12	12.7(1/2")	31.0	1.5	
CC-4	4.6	18.2	12	15.8(5/8")	34.3	1.5	
CC-5	4.6	18.2	11.78	19.4(3/4")	35.0	1.5	
CC-6	4.6	22.0	12	25.4(1")	43.0	1.8	
CC-6.5	4.6	24.0	12	27.5(1 1/16")	50.0	1.8	
CC-7	4.6	26.2	12	31.8(1 1/4")	46.2	1.8	
CC-9	4.6	30.0	12	36.7(1 1/2")	50.0	1.8	

活用护线套 MOVABLE BUSHING

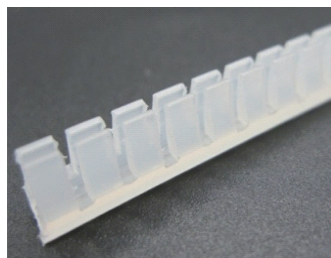

MATERIAL:PE  
COLOR:NATURAL

用法:先将护套一端套于出线孔上,经绕一圈之后,在连接处量适用长度剪断,利用张力顶紧,即可固定。

用途:保护电线和绝缘。

特点:适用于非固定出线孔之最佳产品。

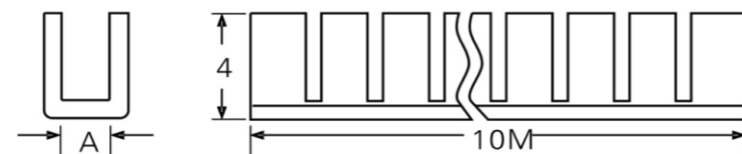

NUIT : mm

Item No.	A	Panel	Packing
HMB-010	1.0	1.0以下	10M
HMB-012	1.2	1.0~1.2	
HMB-016	1.6	1.2~1.6	
HMB-020	2.0	1.6~2.0	
HMB-024	2.4	2.0~2.4	
HMB-030	3.0	2.4~3.0	

护线环 GROMMET(open/closed)



MATERIAL : RUBBER  
用途:用于电线出线口,保护电线不受机壳刮伤。

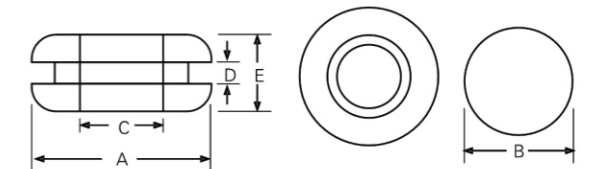

NUIT : mm

Item No.	A	B	C	D	E	Packing
GM-0705	10.2	7.2	5.0	1.7	4.2	1000PCS
GM-1006	13.5	10.0	6.4	1.7	6.1	
GM-1208	16.0	12.0	8.2	1.7	6.2	
GM-1410	19.5	13.9	10.5	1.7	6.2	

扣式护线套 SNAP BUSHINGS



MATERIAL:NYLON 66(UL)  
FLAME CLASS:94V-2  
COLOR:BLACK

用途:使粗劣的钻孔变成圆滑的出线孔。  
各种电线电缆之保护及绝缘。

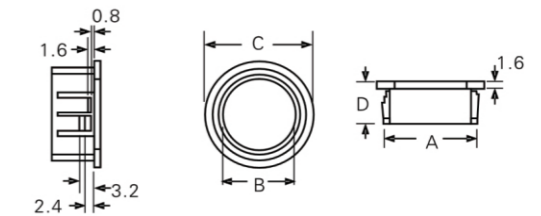

NUIT : mm

Item No.	A	B	C	D	Packing
312-3	8.0	5.2	9.6	8.3	1000PCS
375-4	9.5	6.4	12.0	10.3	
811	11.1	8.2	13.6	10.3	
813	13.0	9.8	15.1	10.3	
1216	16.0	12.9	18.1	10.3	100PCS

扣式护线套 SNAP BUSHINGS



MATERIAL:NYLON 66(UL)  
FLAME CLASS:94V-2  
COLOR:BLACK

用途:使粗劣的钻孔变成圆滑的出线孔。  
各种电线电缆之保护及绝缘。

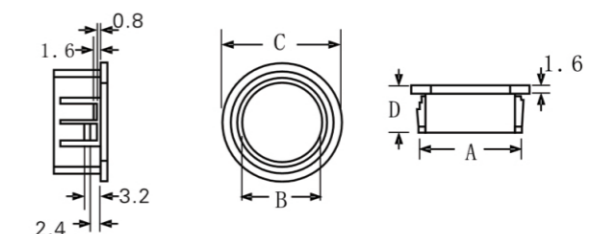

NUIT : mm

Item No.	A	B	C	D	Packing
SB-8	7.8	5.2	9.4	8.3	100PCS
SB-10	9.5	6.3	12.0	10.3	
SB-13	12.7	8.0	14.2	10.3	
SB-16	15.9	12.7	18.6	10.3	
SB-19	19.0	14.3	21.7	10.3	
SB-22	22.0	17.5	24.2	11.5	
SB-25	25.5	19.1	28.5	11.5	
SB-30	30.0	24.1	33.3	11.5	



开口式护线套 SNAP BUSHING(open/closed)



NUIT : mm

Item No.	A	B	C	D	Packing
0813C	12.5-13	9.0	14.6	10.1	100PCS
1216C	15.5-16	12.0	17.8	10.5	
1419C	18-19	14.4	21.0	11.0	

MATERIAL:NYLON 66(UL)

FLAME CLASS:94V-2

COLOR:BLACK

用途:使粗劣的铁孔变成圆滑的出线孔。各种电线电缆之保护及绝缘。

特点:对于出线已装配好而未加任何护套保护时,开口型护套套可于事后再补装(不必重新拆线)而达到保护电线之功能。

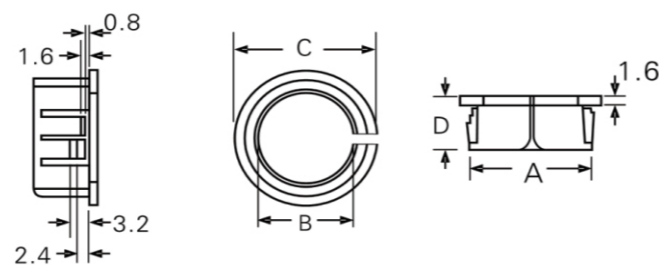

扣式塞头 HOLE PLUG



NUIT : mm

Item No.	A	B	C	Packing
HP-6	5.5	9.8	6.0	1000PCS
HP-8	7.8	11.9	8.0	100PCS
HP-10	9.5	13.0	10.5	
HP-13	12.7	14.6	9.0	
HP-16	15.9	19.8	10.5	
HP-19	19.0	22.9	10.5	
HP-22	22.2	24.9	11.3	
HP-25	25.0	28.3	11.5	
HP-30	30.0	34.2	11.5	

MATERIAL:NYLON 66(UL)

FLAME CLASS:94V-2

COLOR:NATURAL / BLACK / TRANSPARENT

用法:将基板钻孔如A,再行押入即可。厚度3.2mm下铁板均可使用。

用途:可作为预备孔或将其多余孔塞平之用,保持盘面的美观。

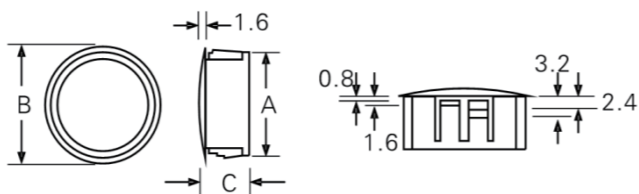

方形线扣 SQYARE STRAIN RELIEF BUSHING



NUIT : mm

Item No.	Will Fit These		Packing
	UL/CSA Description	Size	
SB4F-6	SP T-1, SP T-2	3X5.6, 71 X7.6	100PCS

MATERIAL:NYLON 66(UL)

FLAME CLASS:94V-2

COLOR: BLACK

用法:将基板钻孔如A,再行押入即可。厚度3.2mm下铁板均可使用。

用途:用于机壳的电线出线口,保护电线不受机壳刮伤,装配容易。

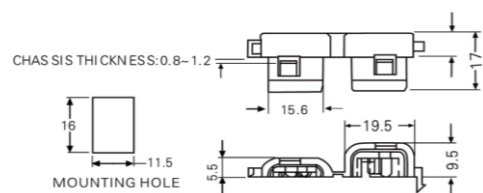

方形线扣 SQYARE STRAIN RELIEF BUSHING



NUIT : mm

Item No.	These			Packing
	UL/CSA	Size	F	
SB4F-4	SPT-1, SPT-2	3X5.6,71X7.6	0.8~1.2	100PCS
SB4F-5	SVT3C#18	6.6~7.2	0.8~1.2	

MATERIAL:NYLON 66(UL)

FLAME CLASS:94V-2

COLOR: BLACK

用途:用于电子电器电源出线口,固定扣牢和保护电源免於被机壳刮伤,造成短路,安装方便快速SB4F-4适用电线为SPT-1和 SPT-2,SB5R-5适用电线为线径 6.6~ 7.2.

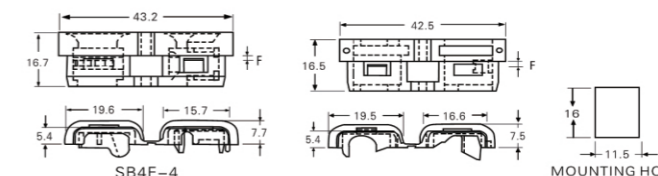

电源线扣 STRAIN RELEF BUSHINGS

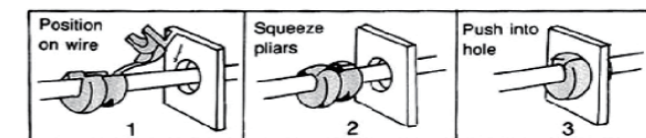

1.將電源線放置綫扣內。2.將綫扣結合夾緊。3.利用綫扣工具夾緊塞入機板出綫孔,即可固定電源綫。

MATERIAL:NYLON 66(UL)

FLAME CLASS:94V-2

COLOR: BLACK / WHITE

用途:使用于各种电器产品,灯饰等电线出口之固定与保护。

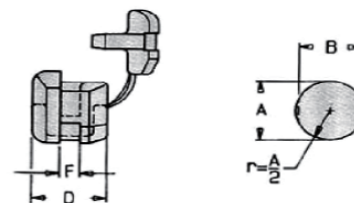

NUIT : mm

Item No.	Cross Section	UL Wires Accommodated	Approx. Wire Size mm	Mounting Holes		Max. Thickness F mm	Length D mm	Packing
				A mm	B mm			
2P-4	Flat (扁线用)	SPT-1	3 X 5.6	9.5	8.7	1.6	10.3	1000PCS
3P-4		SPT-1	3 X 5.6	11	9.9	1.6	10.3	
3W-1		SPT-1	3 X 5.6	11	9.9	2.5	10.3	
4N-4		SPT-2	3.71 3.8X7.6	12.7-13.1	11.8	1.6	10.3	
4K-4	Round (圆线用)	SPT-2	3.71 3.8X7.6	12.7-13.1	11.8	2.5	10.3	500PCS
5N-4		SVI SVT	6.4Φ-7.6 Φ	12.7-13.1	11.5	1.6	11	
5P-4		SVI SVT	6.4Φ-7.6 Φ	12.7-13.1	11.5	2.5	11	
6N-4		SJT 3C#18	7.6 Φ	15.9	14	1.6	14.8	
6P-4		SJT 3C#18	7.6 Φ	15.9	14	3.2	14.8	
6N3-4		SJT 3C#16	8.2Φ-9.2 Φ	15.9	14	1.6	14.8	
6P3-4		SJT 3C#16	8.2Φ-9.2 Φ	15.9	14	3.2	14.8	
7N-2		SJT 3C#14	9.2Φ-10.5Φ 11Φ	19 19.8	16.8	1.6	19	
7P-2		SJT 3C#14	9.2Φ-10.5Φ 11Φ	19 19.8	16.8	3.2	19	
8P-2		SJT 3C#12	12Φ-15.2 Φ	22.2	21.3	3.2	20.8	
9R-1	#18 22-36PCS	11Φ-15.0 Φ	19.0	19.0	1.6	17.5		

电源线扣 STRAIN RELIEF BUSHINGS

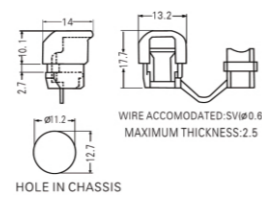
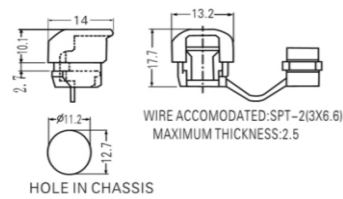

MATERIAL: NYLON 66(UL)  
FLAME CLASS: 94V-2  
COLOR: BLACK  
用途: 用於机壳的电线出线口, 保护电线不受机壳刮伤, 装配容易。

NUIT : mm

Item No.	Packing
SB4L-4	1000PCS

NUIT : mm

Item No.	Packing
SB5L-4	1000PCS

插式电线接头 PUSH-IN WIRE CONNECTOR



MATERIAL: NYLON 66(UL)  
FLAME CLASS: 94V-2  
AMPERE: 24A (VCD)  
VOLT: 600V.  
使用温度: 110°C。  
使用线径范围: # 12-22AWG Solid conductor (单股)。  
拨线长度: 11mm (0.43inch)。  
颜色: 以颜色区分, 易于辨别使用电线数目。

Item No.	Color	Diameter	Holes	Packing
PC252	Red	2.5	2	500PCS
PC253	Orange	2.5	3	
PC254	Yellow	2.5	4	
PC255	Gray	2.5	5	
PC258	Black	2.5	8	200PCS

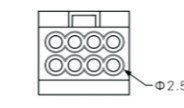
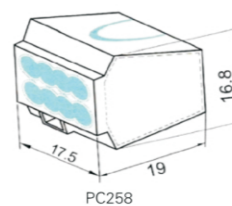
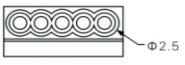
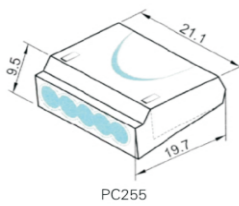
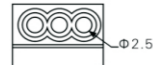
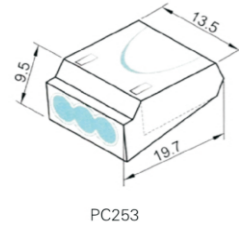
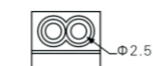
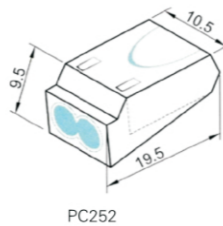
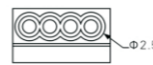
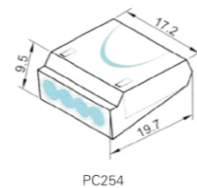

快速接线夹 QUICK SPICE



MATERIAL: NYLON 66(UL) / PP  
FLAME CLASS: 94V-2  
用途: 使用时不须事先剥线, 只要选好位置压扣即可。

NUIT : mm

Item No.	Scope	Color	Packing
3MR	22AWG-18AWG	Red	500PCS
3MB	18AWG-14AWG	Blun	
3MY	12AWG-10AWG	Yellow	
3WR	22AWG-18AWG	Red	
3WB	18AWG-14AWG	Blun	

端子台 TERMINAL BLOCK

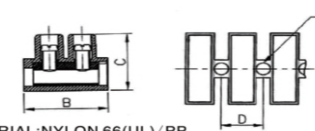
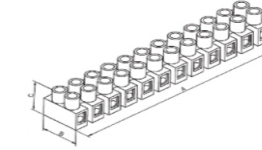
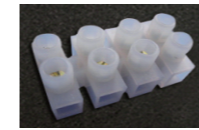

MATERIAL: NYLON 66(UL)/PP  
FLAME CLASS: 94V-2  
Temperature: 110°C。  
ROW: 12排。

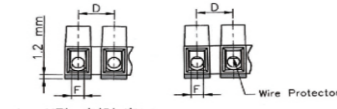

Understoke: H型 底部加高1.2mm。  
Shrapnel: DS型 附加弹片。

NUIT : mm

Item No.	Diameter mm.	Amp	Volt.	Screw	Dimensions(mm/in)						Packing	
					Unit	A	B	C	D	E		F
PA8	1.5	17.5A	450V	M2.6x5	(mm)	95.80	16.30	13.30	8.00	2.90	2.80	25PCS 50PCS 100PCS
					(in)	3.772	0.642	0.524	0.315	0.114	0.11	
PA8 H	1.5	17.5A	450V	M2.6x5	(mm)	96.20	17.00	14.50	8.00	2.90	2.80	
					(in)	3.787	0.669	0.570	0.315	0.114	0.11	
PA8 DS	1.5	17.5A	450V	M2.6x5	(mm)	95.80	16.30	13.30	8.00	2.90	2.80	
					(in)	3.772	0.642	0.524	0.315	0.114	0.11	
PA8 HDS	1.5	17.5A	450V	M2.6x5	(mm)	96.20	17.00	14.50	8.00	2.90	2.80	
					(in)	3.787	0.669	0.570	0.315	0.114	0.11	
PA10	2.5	24.0A	450V	M3.0x6	(mm)	117.5	20.20	15.80	10.00	3.60	3.20	
					(in)	4.626	0.795	0.622	0.394	0.142	0.126	
PA10 H	2.5	24.0A	450V	M3.0x6	(mm)	117.5	20.20	17.00	10.00	3.60	3.40	
					(in)	4.626	0.795	0.670	0.394	0.142	0.134	
PA10 DS	2.5	24.0A	450V	M3.0x6	(mm)	117.5	20.20	15.80	10.00	3.60	3.20	
					(in)	4.626	0.795	0.622	0.394	0.142	0.126	
PA10 HDS	2.5	24.0A	450V	M3.0x6	(mm)	117.5	20.20	17.00	10.00	3.60	3.40	
					(in)	4.626	0.795	0.670	0.394	0.142	0.134	
PA12	6.0	41.0A	500V	M3.5x7	(mm)	140.7	23.80	19.00	12.00	3.90	4.20	
					(in)	5.400	0.937	0.748	0.472	0.154	0.165	
PA12 DS	6.0	41.0A	500V	M3.5x7	(mm)	140.7	23.80	19.00	12.00	3.90	4.20	
					(in)	5.400	0.937	0.748	0.472	0.154	0.165	
PA14	10.0	57.0A	500V	M4.0x9	(mm)	158.0	25.60	25.20	13.50	4.40	5.00	
					(in)	6.220	1.008	0.992	0.531	0.173	0.197	
PA14 DS	10.0	57.0A	500V	M4.0x9	(mm)	158.0	25.60	25.20	13.50	4.40	5.00	
					(in)	6.220	1.008	0.992	0.531	0.173	0.197	

矽胶片 SILICON INSULATOR

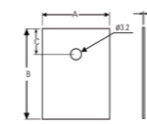

MATERIAL: SILICON  
FLAME CLASS: 94V-0  
用途: 锁於功率晶体与散热片之间, 导热、绝对性特佳。

NUIT : mm

Item No.	A	B	C	Packing
TO-3P	19.0	25.0	7.2	1000PCS
TO-220P	13.2	19.0	5.0	

保险丝盖 FUSE COVER

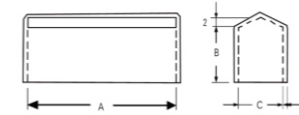
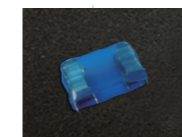

MATERIAL: PVC  
FLAME CLASS: 94V-0  
用途: 用於保险丝之绝缘与防尘。

NUIT : mm

Item No.	A	B	C	Packing
FUSE-1	20.0	11.0	6.0	1000PCS
FUSE-2	31.8	11.5	9.5	
FUSE-3	36.1	9.9	8.1	



**端子保护套管 VINYL WIRE END**

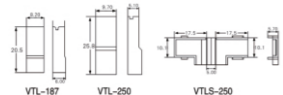
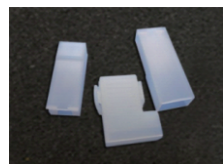

MATERIAL : NYLON 66  
FLAME CLASS : 94V-0  
用途 : 用于端子之绝缘。

NUIT : mm

Item No.	适用于端子	Packing
VTL-187	187	1000PCS
VTL-250	250	
VTLS-250	旗形250	

**末端保护套管 END CAP**

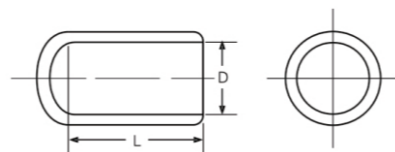

MATERIAL : PVC  
COLOR : RED / BLUE / YELLOW / BLACK / WHITE / GREEN  
用途 : 用于末端保护之作用。

NUIT : mm

Item No.	D	L	Packing
ECP-0810	8.0	10.0	1000PCS
ECP-XY	X	Y	

**防尘帽 CONNECTOR COVER**



MATERIAL : PE  
FLAME CLASS : 94V-0  
用途 : 用于连接器之防尘保护。

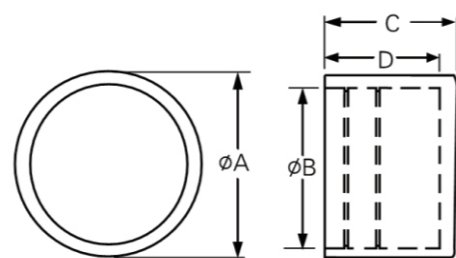

NUIT : mm

Item No.	A	B	C	D	Packing
KPS-1	15.8	13.4	11.2	10.0	1000PCS

**脚垫 PLASTIC FOOT**

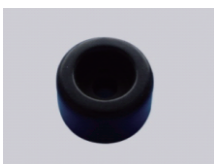

MATERIAL : ABS  
COLOR : BLACK  
用途 : 机械外壳之座垫, 使用螺丝固定, 安全不脱落, 耐重压。

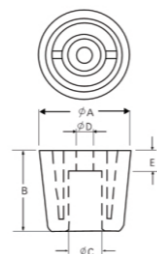

NUIT : mm

Item No.	A	B	C	D	E	Packing
FFT-1	15.0	8.0	7.5	3.7	3.5	1000PCS
FFT-2	20.0	12.1	8.2	4.1	5.5	500PCS
FFT-3	25.1	16.2	10.4	4.3	8.1	100PCS
FFT-4	24.4	22.4	8.9	4.6	6.0	
FFT-5	26.0	12.7	10.9	5.1	5.7	
FFT-6	22.5	22.4	8.6	4.6	6.0	
FFT-7	17.0	22.4	8.6	4.6	6.0	

**脚垫 PLASTIC FOOT**



MATERIAL : TPR / PE / PP  
COLOR : BLACK  
用途 : 插销式, 可快速将脚垫固定于机壳不脱落

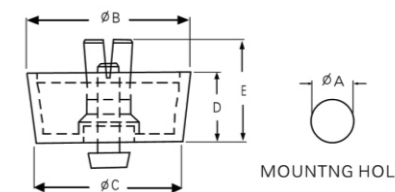

NUIT : mm

Item No.	A	B	C	D	E	Chassis Thickness	Packing
FF-1	8.0	20.8	19.8	6.4	11.8	1.0~2.5	500PCS
FF-2	8.0	20.0	18.0	10.0	15.4	1.0~2.5	
FF-3	8.0	23.7	19.5	13.7	19.2	1.0~2.5	250PCS
FF-4	8.0	25.0	23.5	6.5	12.5	1.0~2.5	500PCS
FF-5	8.0	30.0	27.7	12.8	18.8	1.0~2.5	200PCS
FF-6	10.0	28.5	26.5	8.2	14.0	1.0~3.5	250PCS
FF-7	5.0	12.7	12.0	4.4	8.5	1.0~2.0	1000PCS
FF-8	5.0	15.7	15.0	4.4	8.5	1.0~2.0	
FF-9	8.0	20.0	18.6	4.0	7.0	1.0~2.0	500PCS
FF-10	8.0	23.8	22.0	5.0	10.0	1.0~2.5	
FF-11	10.0	31.5	28.5	7.8	13.6	1.0~3.5	250PCS
FF-12	8.0	20.0	18.0	15.0	20.8	1.0~3.0	
FF-13	8.0	20.0	18.0	18.0	24.3	0.8~1.0	
FF-14	8.0	19.5	18.7	5.0	10.5	0.8~2.0	500PCS
FF-21	8.0	20.0	19.3	20.5	25.6	0.8~2.0	250PCS
FF-22	8.0	19.2	17.2	7.9	12.1	0.8~1.2	500PCS
FF-24	8.0	23.0	21.0	8.0	13.3	0.8~2.0	250PCS
FF-25	8.0	24.0	20.0	10.5	5.3	0.8~2.0	

**脚垫 PLASTIC FOOT**

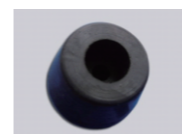

MATERIAL : NYLON 66  
COLOR : BLACK  
用途 : 机壳外壳之座垫, 使用螺丝固定, 安全不脱落。

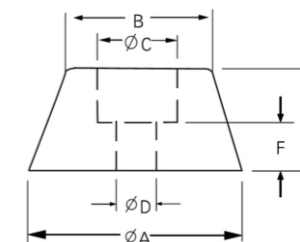

NUIT : mm

Item No.	A	B	C	D	E	F	Material	Packing
NF-001	14.8	8.0	6.0	3.0	7.0	3.1	P.V.C	1000PCS
NF-002	11.5	8.7	5.6	3.2	7.4	3.3	RUBBER	
NF-004	16.0	13.0	6.0	3.0	7.8	4.0		
NF-005	17.2	16.2	9.0	4.0	7.0	3.0	P.V.C	500PCS
NF-006	20.2	18.4	10.0	3.0	8.0	4.0		
NF-007	25.0	21.5	8.5	3.3	5.8	2.8		
NF-008	20.0	15.0	9.8	3.0	10.5	5.0		
NF-008A	20.0	15.0	9.8	4.0	10.5	5.0	P.P	1000PCS
NF-009	11.0	8.8	6.0	3.5	5.7	2.3		
NF-013	18.0	13.7	7.8	3.5	9.8	2.7	P.V.C	100PCS
NF-014	28.0	21.2	9.7	3.8	20.0	6.0		

自黏脚垫 RUBBER FOOT

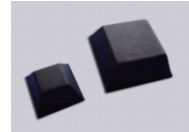

MATERIAL : NYLON 66  
 COLOR : BLACK  
 用途:插销式,可快速将脚垫固定于机壳不脱落。

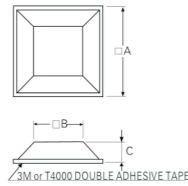

NUIT : mm

Item No.	A	B	C
SF-004	12.7	9.0	3.5
SF-005	12.7	7.0	6.0
SF-006	20.5	14.0	7.6
SF-007	10.5	8.6	2.5
SF-009	12.5	9.5	4.0

电缆固定座 Cable holder



MATERIAL:A, C, FIS Pa66 ,B, D IS EPDM  
 FLAME CLASS:94V-2  
 Operating temperature : Minus 40 degrees Celsius to 100 degrees Celsius

NUIT : mm

Threaded Specifications	Item No.		Cable Range	Thread O.D. C 1	Panel Mounting Hole	Thread Length C 2	Spanner Size A & F	Std.Pkg. PCS	
	Black	Gray							
LONG THREAD	M12 x 1.5	MG12A - 05B MG12A - 05G	5. 3~3	12	12~12. 3	9	18/19	50	
	M12 x 1.5	MG12A - 08B MG12A - 08G	8~4. 5	12	12~12. 3	9	18/19	50	
	M16 x 1.5	MG16A - 06B MG16A - 06G	7~4	16	16~16. 3	15	22/22	50	
	M16 x 1.5	MG16A - 10B MG16A - 10G	10~6	16	16~16. 3	15	22/22	50	
	M20 x 1.5	MG20A - 10B MG20A - 10G	11~6	20	20~20. 3	15	27/27	50	
	M20 x 1.5	MG20A - 14B MG20A - 14G	14~9	20	20~20. 3	15	27/27	50	
	M25 x 1.5	MG25A - 16B MG25A - 16G	16~10	25	25~25. 4	15	33/33	50	
	M25 x 1.5	MG25A - 18B MG25A - 18G	18~13	25	25~25. 4	15	33/33	50	
	M32 x 1.5	MG32A - 22B MG32A - 22G	22~15	32	32~32. 4	15	41/41	10	
	M32 x 1.5	MG32A - 35B MG32A - 35G	25~18	32	32~32. 4	15	41/41	10	
	M40 x 1.5	MG40A - 25B MG40A - 25G	25~20	40	40~40. 4	20	50/50	10	
	M40 x 1.5	MG40A - 30B MG40A - 30G	30~24	40	40~40. 4	20	50/50	10	
	M50 x 1.5	MG50A - 32B MG50A - 32G	32~26	50	50~50. 4	22	62/62	10	
	M50 x 1.5	MG50A - 39B MG50A - 39G	41~31	50	50~50. 4	22	62/62	10	
	M63 x 1.5	MG63A - 46B MG63A - 46G	46~40	63	63~63. 4	25	75/75	10	
	M63 x 1.5	MG63A - 49B MG63A - 49G	51~44	63	63~63. 4	25	75/75	10	
	M90 x 2.0	MG90A - 68B MG90A - 68G	68~58	90	90~91	25	110/110	2	
	M90 x 2.0	MG90A - 77B MG90A - 77G	77~66	90	90~91	25	110/110	2	
	SHORT THREAD	PG 7	PGB7 - 05B PGG7 - 05G	5. 3~3	12.5	12. 5~12. 8	8.5	17/15	50
		PG 7	PGB7 - 07B PGG7 - 07G	7~4	12.5	12. 5~12. 8	8.5	17/15	50
PG 9		PGB9 - 09B PGG9 - 09G	8~4. 5	15.2	15. 2~15. 5	8.5	22/19	50	
PG 11		PGB11 - 07B PGG11 - 07G	7~4	18.6	18. 6~18. 9	9	24/22	50	
PG 11		PGB11 - 10B PGG11 - 10G	10~6	18.6	18. 6~18. 9	9	24/22	50	
PG 13.5		PGB13.5 - 08B PGG13.5 - 08G	8. 8~5	20.4	20. 4~20. 7	10	27/24	50	
PG 13.5		PGB13.5 - 12B PGG13.5 - 12G	12. 5~7	20.4	20. 4~20. 7	10	27/24	50	
PG 16		PGB16 - 10B PGG16 - 10G	11~6	22.5	22. 5~22. 8	10	30/27	50	
PG 16		PGB16 - 14B PGG16 - 14G	14~8. 5	22.5	22. 5~22. 8	10	30/27	50	
PG 21		PGB21 - 16B PGG21 - 16G	16~10	28.3	28. 3~28. 7	12	36/33	50	
PG 21		PGB21 - 18B PGG21 - 18G	18~12. 5	28.3	28. 3~28. 7	12	36/33	50	
PG 29		PGB29 - 22B PGG29 - 22G	22~16	37	37~37. 4	15	46/41	10	
PG 29		PGB29 - 25B PGG29 - 25G	25~18	37	37~37. 4	15	46/41	10	
PG 36		PGB36 - 25B PGG36 - 25G	25~20	47	47~47. 4	15	57/50	10	
PG 36		PGB36 - 30B PGG36 - 30G	32~24	47	47~47. 4	15	57/50	10	
PG 42		PGB42 - 32B PGG42 - 32G	32~26	54	54~54. 4	15.5	64/62	10	
PG 42		PGB42 - 39B PGG42 - 39G	41~31	54	54~54. 4	15.5	64/62	10	
PG 48		PGB48 - 38B PGG48 - 38G	38~30	59.3	59. 3~59. 7	15.5	70/65	10	
PG 48		PGB48 - 45B PGG48 - 45G	45~35	59.3	59. 3~59. 7	15.5	70/65	10	

电缆固定座 Cable holder



Long screw type cable fixed head (A) type

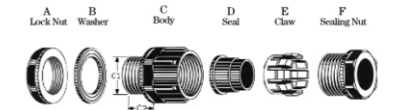

Long screw type resistance to torsional cable fixed head (A) type



NUIT : mm

Threaded Specifications	Item No.		Cable Range	Thread O.D. C 1	Panel Mounting Hole	Thread Length C 2	Spanner Size A & F	Std.Pkg. PCS	
	Black	Gray							
LONG THREAD	M12 x 1.5	MG12A - 05B MG12A - 05G	5. 3~3	12	12~12. 3	9	18/19	50	
	M12 x 1.5	MG12A - 08B MG12A - 08G	8~4. 5	12	12~12. 3	9	18/19	50	
	M16 x 1.5	MG16A - 06B MG16A - 06G	7~4	16	16~16. 3	15	22/22	50	
	M16 x 1.5	MG16A - 10B MG16A - 10G	10~6	16	16~16. 3	15	22/22	50	
	M20 x 1.5	MG20A - 10B MG20A - 10G	11~6	20	20~20. 3	15	27/27	50	
	M20 x 1.5	MG20A - 14B MG20A - 14G	14~9	20	20~20. 3	15	27/27	50	
	M25 x 1.5	MG25A - 16B MG25A - 16G	16~10	25	25~25. 4	15	33/33	50	
	M25 x 1.5	MG25A - 18B MG25A - 18G	18~13	25	25~25. 4	15	33/33	50	
	M32 x 1.5	MG32A - 22B MG32A - 22G	22~15	32	32~32. 4	15	41/41	10	
	M32 x 1.5	MG32A - 35B MG32A - 35G	25~18	32	32~32. 4	15	41/41	10	
	M40 x 1.5	MG40A - 25B MG40A - 25G	25~20	40	40~40. 4	20	50/50	10	
	M40 x 1.5	MG40A - 30B MG40A - 30G	30~24	40	40~40. 4	20	50/50	10	
	M50 x 1.5	MG50A - 32B MG50A - 32G	32~26	50	50~50. 4	22	62/62	10	
	M50 x 1.5	MG50A - 39B MG50A - 39G	41~31	50	50~50. 4	22	62/62	10	
	M63 x 1.5	MG63A - 46B MG63A - 46G	46~40	63	63~63. 4	25	75/75	10	
	M63 x 1.5	MG63A - 49B MG63A - 49G	51~44	63	63~63. 4	25	75/75	10	
	M90 x 2.0	MG90A - 68B MG90A - 68G	68~58	90	90~91	25	110/110	2	
	M90 x 2.0	MG90A - 77B MG90A - 77G	77~66	90	90~91	25	110/110	2	
	SHORT THREAD	PG 7	PGB7 - 05B PGG7 - 05G	5. 3~3	12.5	12. 5~12. 8	8.5	17/15	50
		PG 7	PGB7 - 07B PGG7 - 07G	7~4	12.5	12. 5~12. 8	8.5	17/15	50
PG 9		PGB9 - 09B PGG9 - 09G	8~4. 5	15.2	15. 2~15. 5	8.5	22/19	50	
PG 11		PGB11 - 07B PGG11 - 07G	7~4	18.6	18. 6~18. 9	9	24/22	50	
PG 11		PGB11 - 10B PGG11 - 10G	10~6	18.6	18. 6~18. 9	9	24/22	50	
PG 13.5		PGB13.5 - 08B PGG13.5 - 08G	8. 8~5	20.4	20. 4~20. 7	10	27/24	50	
PG 13.5		PGB13.5 - 12B PGG13.5 - 12G	12. 5~7	20.4	20. 4~20. 7	10	27/24	50	
PG 16		PGB16 - 10B PGG16 - 10G	11~6	22.5	22. 5~22. 8	10	30/27	50	
PG 16		PGB16 - 14B PGG16 - 14G	14~8. 5	22.5	22. 5~22. 8	10	30/27	50	
PG 21		PGB21 - 16B PGG21 - 16G	16~10	28.3	28. 3~28. 7	12	36/33	50	
PG 21		PGB21 - 18B PGG21 - 18G	18~12. 5	28.3	28. 3~28. 7	12	36/33	50	
PG 29		PGB29 - 22B PGG29 - 22G	22~16	37	37~37. 4	15	46/41	10	
PG 29		PGB29 - 25B PGG29 - 25G	25~18	37	37~37. 4	15	46/41	10	
PG 36		PGB36 - 25B PGG36 - 25G	25~20	47	47~47. 4	15	57/50	10	
PG 36		PGB36 - 30B PGG36 - 30G	32~24	47	47~47. 4	15	57/50	10	
PG 42		PGB42 - 32B PGG42 - 32G	32~26	54	54~54. 4	15.5	64/62	10	
PG 42		PGB42 - 39B PGG42 - 39G	41~31	54	54~54. 4	15.5	64/62	10	
PG 48		PGB48 - 38B PGG48 - 38G	38~30	59.3	59. 3~59. 7	15.5	70/65	10	
PG 48		PGB48 - 45B PGG48 - 45G	45~35	59.3	59. 3~59. 7	15.5	70/65	10	